

HP 8753C
NETWORK ANALYZER
Reference



Reference

TABLE OF CONTENTS

Chapter 1. System Overview			
Guide to the Chapters in this Document	1-1		
System Overview	1-2		
Data Processing	1-3		
Chapter 2. Front Panel and Softkey Operation			
Active Function	2-1		
Front Panel Keys and Softkey Menus	2-1		
Front Panel Features	2-4		
CRT Display	2-6		
Status Notations	2-7		
Active Channel Keys	2-8		
Entry Block Keys	2-9		
Rear Panel Features and Connections	2-11		
Chapter 3. Stimulus Function Block			
Test Set Attenuator, Test Port Transfer Switch, and Doubler Switch Protection	3-2		
[START], [STOP], [CENTER], and [SPAN] keys	3-3		
[MENU] Key (Stimulus, Power, Trigger, Sweep Type, and Frequency List)	3-4		
Chapter 4. Response Function Block			
[MEAS] Key (S-Parameter, Input Port, and Conversion)	4-3		
[FORMAT] Key (Display Format and Group Delay)	4-8		
[SCALE REF] Key (Scale Reference)	4-16		
[DISPLAY] Key (Dual Channel, Split Display, CRT control, Data and Memory Functions, Beep Control, D2/D1 to D2, Color Adjustment, Frequency Blank, and Titles)	4-18		
[AVG] Key	4-28		
Chapter 5. Measurement Calibration			
Accuracy Enhancement	5-2		
Sources of Measurement Errors	5-2		
Correcting for Measurement Errors	5-5		
Frequency Response of Calibration Standards	5-8		
Menus and Softkeys	5-10		
[CAL] Key (Calibration Menus and Procedures)	5-10		
Purpose and Use of Different Calibration Procedures (Table)	5-20		
Response Calibration for Reflection Measurements	5-21		
Response Calibration for Transmission Measurements	5-22		
Response and Isolation Calibration for Reflection Measurements	5-22		
		Response and Isolation Calibration for Transmission Measurements	5-23
		S ₁₁ 1-Port Calibration for Reflection Measurements	5-24
		S ₂₂ 1-Port Calibration	5-25
		Full 2-Port Calibration for Reflection and Transmission Measurements	5-25
		One-Path 2-Port Calibration for Reflection and Transmission Measurements	5-27
		Power Meter Calibration	5-28
		Using Power Meter Calibration	5-34
		Modifying Calibration Kits	5-41
		Verify Performance	5-51
		Example Procedure	5-52
		Appendix: Accuracy Enhancement Fundamentals	5-53
Chapter 6. Using Markers			
		[MKR] Key (Delta, Fixed, Mode, Polar, and Smith)	6-1
		[MKR FCTN] Key (Marker Function and Search)	6-11
Chapter 7. Instrument State Function Block			
		Instrument State Features and Where They Are Described	7-2
		[LOCAL] Key (HP-IB Menu and Address Menu)	7-2
		[SYSTEM] Key (Limit Lines Description Only)	7-7
		See <i>Instrument State Features and Where They Are Described</i> to determine where other [SYSTEM] Key features are described	
Chapter 8. Time and Frequency			
		Domain Transforms	
		General Theory	8-2
		Time Domain Concepts	8-12
		Transforming CW Time Measurements Into the Frequency Domain	8-19
Chapter 9. Making a Hard Copy Output			
		[COPY] Key	9-2
Chapter 10. Saving Instrument States			
		Types of Memory	10-1
		Internal Save	10-4
		External Store	10-5
		[SAVE] and [RECALL] Keys (With Associated Menus)	10-5

Chapter 11. HP-IB Remote Programming	
How HP-IB Works	11-2
HP-IB Bus Structure	11-3
HP-IB Requirements	11-5
Analyzer HP-IB Capabilities	11-5
Bus Mode	11-6
Setting Addresses	11-7
Valid Characters	11-7
Code Naming Convention	11-7
Units and Terminators	11-8
HP-IB Debug Mode	11-8
CRT Graphics	11-8

Chapter 12. Error Messages	
Error Messages in Alphabetic Order	12-1
Error Messages in Numerical Order	12-9

Chapter 13. Test Sequence Function	
What is Test Sequencing?	13-1
Creating a Sequence	13-2
Running a Sequence	13-2
Stopping a Sequence	13-2
Changing the Sequence Title	13-3
Editing a Sequence	13-3
Clearing a Sequence from Memory	13-4
Storing a Sequence to Disk	13-4
Loading a Sequence from Disk	13-5
Purging a Sequence from Disk	13-6
Printing a Sequence	13-6

In-Depth Sequencing Information	13-6
Basic Sequencing Menus	13-8
Sequencing Special Functions	13-15
Important Concepts	13-15
Autostarting Sequences	13-16
Sequencing Special Function Menus	13-16
HP-GL Considerations	13-20
Entering Sequences Using HP-IB	13-21
Reading Sequences Using HP-IB	13-21
Decision-Making Example Sequences	13-21

Chapter 14. Instrument Modes, 6 GHz, Frequency Offset, and Harmonic Operation	
Instrument Modes	14-2
Instrument Mode Overview	14-2
Network Analyzer Mode	14-4
External Source Mode	14-4
Tuned Receiver Mode	14-6
Other System Key Features	14-8
Feature Overview	14-8
Frequency Offset Operation	14-8
6 GHz Operation (Option 006)	14-12
Harmonic Operation (Option 002 Only)	14-14
Spurious Signal Passbands in External Source Mode, Tuned Receiver Mode, and Frequency Offset Operation	14-17

Appendix A	
PRESET State	A-1
Operating Softkey Menu Map	A-4

Chapter 1. System Overview

CHAPTER CONTENTS

- 1-2 System Overview
- 1-3 Data Processing

GUIDE TO THE CHAPTERS IN THIS DOCUMENT

For information on specific topics, refer to the index at the end of this volume.

This section of this document is a complete reference for operation of the HP 8753C Network Analyzer using either front panel controls, test sequence function, or an external controller. The information in this reference is intended to supplement the separately bound tutorial documents in this volume with additional details. It is divided into chapters providing the following information:

- **Chapter 1** includes a block diagram and functional description of the analyzer system. This is followed by descriptions of the front panel features and CRT labels, and the rear panel features and connectors.
- **Chapters 2 through 10** provide detailed information on front panel keys and softkeys, their purpose and use, HP-IB equivalents in parentheses, and expected indications and results. Specific areas of operation described in these chapters include calibration procedures for accuracy enhancement, using markers, limit testing, time domain measurements (option 010), plotting and printing, and saving instrument states. Power meter calibration and interpolated error correction are described in chapter 5.
- **Chapter 11** contains information for operating the system remotely with a controller through HP-IB.
- **Chapter 12** lists analyzer error messages, with explanations.
- **Chapter 13** describes the test sequencing function.
- **Chapter 14** describes tuned receiver, external source, frequency offset, as well as optional harmonic and 6 GHz instrument modes. 6 GHz mode only functions when the analyzer is used with an HP 85047A 6 GHz S-parameter Test Set. The test set contains a frequency doubler. External source and tuned receiver modes allow an HP 8753C Option 006 to make measurements up to 6 GHz without an HP 85047A Test Set. An external source and a signal separation device are required. In addition, tuned receiver mode requires a synthesized source.

An appendix at the end of this reference provides a complete listing of the instrument preset state, a data processing flow diagram, a map of the operating softkey menu structure, and an alphabetical index.

SYSTEM OVERVIEW

Network analyzers measure the reflection and transmission characteristics of devices and networks by applying a known swept signal and measuring the responses of the test device. The signal transmitted through the device or reflected from its input is compared with the incident signal generated by a swept RF source. The signals are applied to a receiver for measurement, signal processing, and display. A network analyzer system consists of a source, signal separation devices, a receiver, and a display.

The HP 8753C vector network analyzer integrates a high resolution synthesized RF source and a dual channel three-input receiver to measure and display magnitude, phase, and group delay of transmitted and reflected power. The HP 8753C Option 010 has the additional capability of transforming measured data from the frequency domain to the time domain. Other options are explained in the *General Information and Specifications* section. Figure 1-1 is a simplified block diagram of the network analyzer system. A detailed block diagram of the analyzer is provided in the *On-Site System Service Manual*, together with complete theory of system operation.

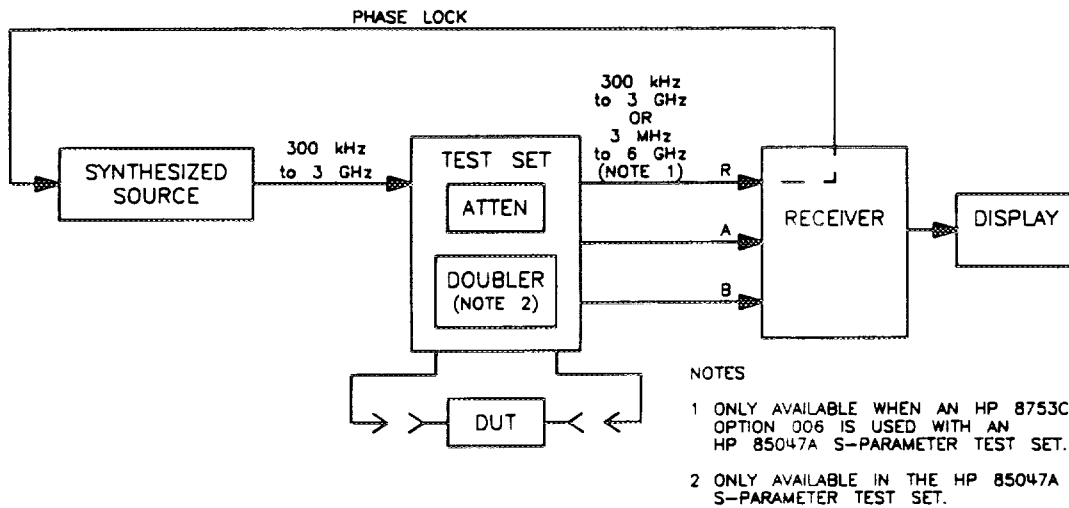

Figure 1-1. Simplified Block Diagram of the Network Analyzer System

The Built-In Synthesized Source

The analyzer's built-in synthesized source produces a swept RF signal in the range of 300 kHz to 3.0 GHz. Option 006, 6 GHz receiver operation, does not change the frequency range of the internal source. Frequency coverage to 6 GHz must be provided by the doubler within the HP 85047A 6 GHz test set, or by an external source. The RF output power is leveled by an internal ALC (automatic leveling control) circuit. To achieve frequency accuracy and phase measuring capability, the analyzer is phase locked to a highly stable crystal oscillator. For this purpose, a portion of the transmitted signal is routed via the test set or other external coupling to the R input of the receiver, where it is sampled by the phase detection loop and fed back to the source.

Test Sets

A test set provides connections to the device under test, as well as the signal separation devices that separate the incident signal from the transmitted and reflected signals. The incident signal is applied to the R (reference) input, and transmitted and reflected signals are applied to the A or B inputs.

The HP 85046A/B and 85047A S-parameter test sets contain the hardware required to make simultaneous transmission and reflection measurements in both the forward and reverse directions. An RF path switch in the test set is controlled by the network analyzer so that reverse measurements can be made without changing the connections to the device under test. The HP 85044A/B Transmission/Reflection Test Set contains the hardware required to make simultaneous transmission and reflection measurements in one direction only. The HP 11850C/D three-way power splitter or the HP 11667A two-way power splitter can be used for making transmission-only measurements.

Test Set Step Attenuator. The step attenuator contained in the test set is used to adjust the power level to the DUT without changing the level of the incident power in the reference path. The attenuator in the HP 85046A/B or 85047A test sets is controlled from the front panel of the analyzer. The attenuator in the HP 85044A/B test set is controlled manually.

The Receiver Block

The receiver block contains three identical sampler/mixers for the R, A, and B inputs. The signals are sampled, and mixed to produce a 4 kHz IF (intermediate frequency). A multiplexer sequentially directs each of the three signals to the ADC (analog to digital converter) where it is converted from an analog to a digital signal to be measured and processed for display on the CRT. Both amplitude and phase information are measured simultaneously, regardless of what is displayed on the CRT.

The Microprocessor. A microprocessor takes the raw data and performs all the required error correction, trace math, formatting, scaling, and marker operations, according to the instructions from the front panel. The formatted data is then displayed on the CRT. The data processing sequence is described below.

Calibration Standards

In addition to the analyzer and the test set (or power splitter), a measurement may require calibration standards for vector accuracy enhancement, and cables for interconnections. Model numbers and details of compatible power splitters, calibration kits, and cables are provided in the *General Information and Specifications* section of this manual.

DATA PROCESSING

Overview

The analyzer's receiver converts the R, A, and B input signals into useful measurement information. This conversion occurs in two main steps. First, the swept high frequency input signals are translated to fixed low frequency IF signals, using analog sampling or mixing techniques. (Refer to *Theory of Operation* in the *On-Site System Service Manual* for details.) Second, the IF signals are converted into digital data by an analog-to-digital converter (ADC). From this point on, all further signal processing is performed mathematically by the analyzer microprocessors. The following paragraphs describe the sequence of math operations and the resulting data arrays as the information flows from the ADC to the display. They provide a good foundation for understanding most of the response functions, and the order in which they are performed.

Figure 1-2 is a data processing flow diagram that represents the flow of numerical data from IF detection to display. The data passes through several math operations, denoted in the figure by single-line boxes. Most of these operations can be selected and controlled with the front panel RESPONSE block menus. The data is also stored in arrays along the way, denoted by double-line boxes. These arrays are places in the flow path where data is accessible, usually via HP-IB.

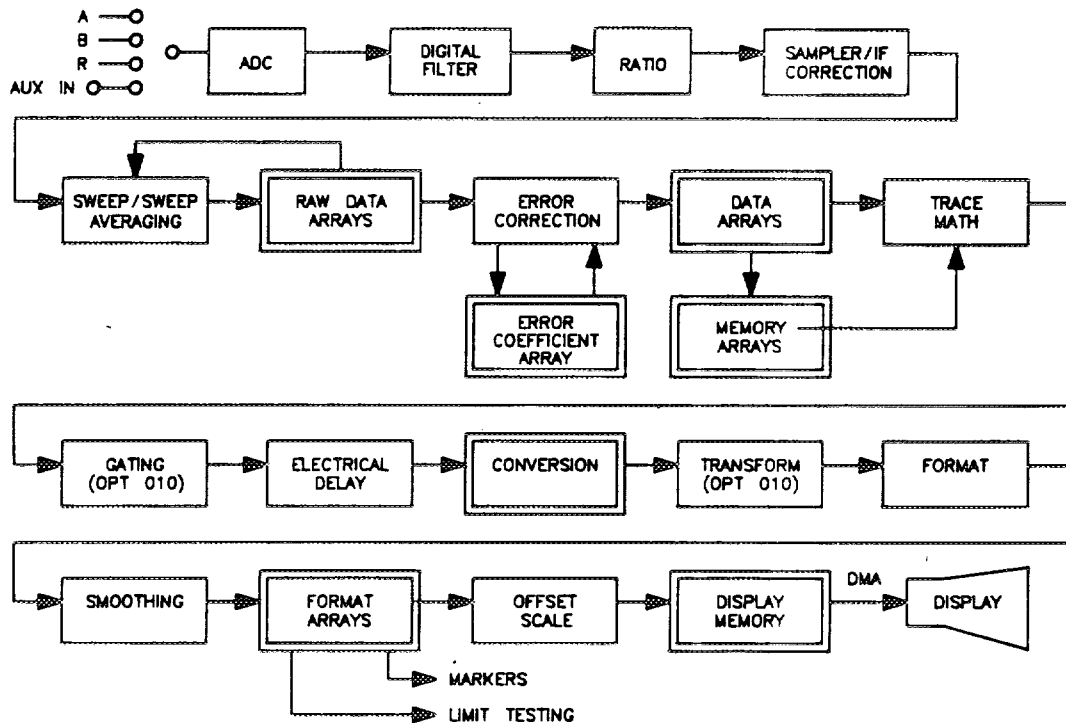

Figure 1-2. Data Processing Flow Diagram

While only a single flow path is shown, two identical paths are available, corresponding to channel 1 and channel 2. When the channels are uncoupled, each channel can be independently controlled, so that the data processing operations for one are different from the other.

Two definitions are necessary:

A "data point" or "point" is a single piece of data representing a measurement at a single stimulus value. Most data processing operations are performed point-by-point; some involve more than one point.

A "sweep" is a series of consecutive data point measurements, taken over a sequence of stimulus values. A few data processing operations require that a full sweep of data is available. The number of points per sweep can be defined by the user. Note that the meaning of the stimulus values (independent variables) can change, depending on the sweep mode, although this does not generally affect the data processing path.

Processing Details

The ADC. The ADC converts the R, A, and B inputs (already down-converted to a fixed low frequency IF) into digital words. (The AUX INPUT connector on the rear panel is a fourth input.) The ADC switches rapidly between these inputs, so they are converted nearly simultaneously. (Refer to [MEAS] Key in Chapter 4 for more information on inputs.)

IF Detection. This occurs in the digital filter, which performs the discrete Fourier transform (DFT) on the digital words. The samples are converted into complex number pairs (real plus imaginary, $R+jI$). The complex numbers represent both the magnitude and phase of the IF signal. If the AUX INPUT is selected, the imaginary part of the pair is set to zero. The DFT filter shape can be altered by changing the IF bandwidth, which is a highly effective technique for noise reduction. (Refer to [AVG] Key in Chapter 4 for information on different noise reduction techniques.)

Ratio Calculations. These are performed if the selected measurement is a ratio of two inputs (e.g. A/R or B/R). This is simply a complex divide operation. If the selected measurement is absolute (e.g. A or B), no operation is performed. The R, A, and B values are also split into channel data at this point. (Refer to [MEAS] Key in Chapter 4 for more information.)

Sampler/IF Correction. The next digital processing technique used is sampler/IF correction. This process digitally corrects for frequency response errors (both magnitude and phase, primarily sampler rolloff) in the analog down-conversion path.

Sweep-to-sweep Averaging. This is another noise reduction technique. This calculation involves taking the complex exponential average of several consecutive sweeps. This technique cannot be used with single-input measurements. (Refer to [AVG] Key in Chapter 4.)

Raw Data Arrays. These store the results of all the preceding data processing operations. (Up to this point, all processing is performed real-time with the sweep by the IF processor. The remaining operations are not necessarily synchronized with the sweep, and are performed by the main processor.) When full 2-port error correction is on, the raw arrays contain all four S-parameter measurements required for accuracy enhancement. When the channels are uncoupled (coupled channels off), there may be as many as eight raw arrays. These arrays are directly accessible via HP-IB. Note that the numbers here are still complex pairs.

Vector Error Correction (accuracy enhancement). Error correction is performed next, if a measurement calibration has been performed and correction is turned on. Error correction removes repeatable systematic errors (stored in the error coefficient arrays) from the raw arrays. This can vary from simple vector normalization to full 12-term error correction. (Refer to Chapter 5 for details.)

The error coefficient arrays themselves are created during a measurement calibration using data from the raw arrays. These are subsequently used whenever correction is on, and are accessible via HP-IB.

The results of error correction are stored in the data arrays as complex number pairs. These arrays are accessible via HP-IB.

If the data-to-memory operation is performed, the data arrays are copied into the memory arrays. (Refer to [DISPLAY] Key in Chapter 4.)

Trace Math Operation. This selects either the data array, memory array, or both to continue flowing through the data processing path. In addition, the complex ratio of the two (data/memory) or the difference (data - memory) can also be selected. If memory is displayed, the data from the memory arrays goes through exactly the same data processing flow path as the data from the data arrays. (Refer to [DISPLAY] Key in Chapter 4 for information on memory math functions.)

Gating. This is a digital filtering operation associated with time domain transformation (option 010 only). Its purpose is to mathematically remove unwanted responses isolated in time. In the time domain, this can be viewed as a time-selective bandpass or band-stop filter. (If both data and memory are displayed, gating is applied to the memory trace only if gating was on when data was stored into memory.) (Refer to Chapter 8.)

The Delay Block. This involves adding or subtracting phase in proportion to frequency. This is equivalent to "line-stretching" or artificially moving the measurement reference plane. (Refer to [ELECTRICAL DELAY] under [SCALE/REF] Key in Chapter 4.)

Conversion Transforms. This transforms the measured S-parameter data to the equivalent complex impedance (Z) or admittance (Y) values, or to inverse S-parameters (1/S). (Refer to *Conversion Menu* under [MEAS] Key in Chapter 4.)

Windowing. This is a digital filtering operation that prepares (enhances) the frequency domain data for transformation to time domain. (Refer to Chapter 8, *Time and Frequency Domain Transforms*.)

Time Domain Transform. This converts frequency domain information into the time domain when transform is on (option 010 only). The results resemble time domain reflectometry (TDR) or impulse-response measurements. The transform employs the chirp-Z inverse fast Fourier transform (FFT) algorithm to accomplish the conversion. The windowing operation, if enabled, is performed on the frequency domain data just before the transform. (A special transform mode is available to "demodulate" CW sweep data, with time as the stimulus parameter, and display spectral information with frequency as the stimulus parameter.) (Refer to Chapter 8 for details.)

Formatting. This converts the complex number pairs into a scalar representation for display, according to the selected format. This includes group delay calculations. These formats are often easier to interpret than the complex number representation. (Polar and Smith chart formats are not affected by the scalar formatting.) Note that after formatting, it is impossible to recover the complex data. (Refer to [FORMAT] Key in Chapter 4 for information on the different formats available and on group delay principles.)

Smoothing. This is another noise reduction technique, that smoothes noise on the trace. When smoothing is on, each point in a sweep is replaced by the moving average value of several adjacent (formatted) points. The number of points included depends on the smoothing aperture, which can be selected by the user. The effect is similar to video filtering. If data and memory are displayed, smoothing is performed on the memory trace only if smoothing was on when data was stored into memory. (Refer to [AVG] Key in Chapter 4 for information about smoothing.)

Format Arrays. The results so far are stored in the format arrays. It is important to note that marker values and marker functions are all derived from the format arrays. Limit testing is also performed on the formatted data. The format arrays are accessible via HP-IB.

Offset and Scale. These operations prepare the formatted data for display on the CRT. This is where the reference line position, reference line value, and scale calculations are performed, as appropriate to the format. (Refer to [SCALE/REF] Key in Chapter 4.)

Display Memory. The display memory stores the display image for presentation on the CRT. The information here includes gratitudes, annotation, and softkey labels – everything visible on the CRT – in a form similar to plotter commands. If user display graphics are written, these are also stored in display memory. When hardcopy records are made, the information sent to the plotter or printer is taken from display memory.

Finally, the display memory data is sent to the CRT display. The display is updated (refreshed) frequently and asynchronously with the data processing operations, to provide a flicker-free image.

Chapter 2. Front Panel and Softkey Operation

CHAPTER CONTENTS

- 2-1 Introduction
- 2-1 Active Function
- 2-1 Front Panel Keys and Softkey Menus
- 2-4 Front Panel Features
- 2-6 CRT Display
- 2-7 Status Notations
- 2-8 Active Channel Keys
- 2-9 Entry Block Keys
- 2-11 Rear Panel Features and Connections

INTRODUCTION

This chapter describes analyzer operation using front panel controls, and explains the use of softkey menus. It provides illustrations and descriptions of the front panel features, the CRT display and its labels, and the rear panel features and connectors. In addition it provides details of the active channel keys and the entry block.

Analyzer functions are activated from the front panel by the operator using front panel keys or softkeys. (In this manual, all front panel keys and softkey labels are shown in brackets. Front panel keys are shown in bold print, softkeys are shown in italics.)

ACTIVE FUNCTION

The function currently activated is called the active function, and is displayed in the active entry area at the upper left of the CRT. As long as a function is active it can be modified with the ENTRY keypad (refer to Figure 2-1). A function remains active until another function is selected, or **[ENTRY OFF]** is pressed.

FRONT PANEL KEYS AND SOFTKEY MENUS

Some of the front panel keys are used to change instrument functions directly, and others provide access to additional functions available in softkey menus. Softkey menus are lists of up to eight related functions that can be displayed in the softkey label area at the right-hand side of the CRT. The eight keys to the right of the CRT are the softkeys. Pressing one of the softkeys selects the adjacent menu function. This either executes the labeled function and makes it the active function, causes instrument status information to be displayed, or presents another softkey menu.

More than 90 softkey menus are provided for control of numerous operating capabilities. Some of the menus are accessed directly from front panel keys, and some from other menus. For example, the stimulus menu accessed by pressing the **[MENU]** key presents all the stimulus functions such as sweep type, number of points, power, sweep time, and trigger. Pressing **[SWEEP TYPE]** presents another menu for defining sweep type parameters, while pressing **[SWEEP TIME]** allows the required sweep time to be entered directly from the number pad. The **[RETURN]** softkeys are used to return to previous menus, while **[DONE]** is used both to indicate completion of a specific procedure and to return to an earlier menu. In this reference, the menus available from each front panel key are illustrated in "menu maps" to clearly show the sequence of keys that must be pressed to access each function. The first menu map, in Chapter 3, shows the softkey menus accessed from the **[MENU]** key. Detailed descriptions of each softkey function are provided with illustrations of the individual menus.

Usually, whenever a menu changes, the present active function is cleared, unless it is an active marker function.

Softkeys that are Joined by Vertical Lines

In cases where several possible choices are available for a function, they are joined by vertical lines. For example, in the input menu the available inputs and input ratios are listed: A, B, R, A/R, B/R, A/B, and only one can be selected at a time. When a selection has been made from the listed alternatives, that selection is underlined until another selection is made.

Softkeys that Toggle On or Off

Some softkey functions can be toggled on or off, for example averaging, and this is indicated in the softkey label. The current state is reflected in the softkey label.

Example: **[AVERAGING ON off]** The word ON is capitalized, showing that averaging is currently on.

[AVERAGING on OFF] The word OFF is capitalized, showing that averaging is currently off.

Softkeys that Show Status Indications in Brackets

Some softkey labels show the current status of a function in brackets. These include simple toggle functions and status-only indicators. An example of a toggled function is the **[PLOT SPEED FAST]** or **[PLOT SPEED SLOW]** softkey. The **[IF BW]** softkey is an example of a status-only indicator, where the selected value of the IF bandwidth is shown in brackets in the softkey label.

Main Key Function Groups

The front panel keys that provide access to softkey menus are grouped in the STIMULUS, RESPONSE, and INSTRUMENT STATE function blocks.

Stimulus Block. The stimulus block keys and softkey menus control all the functions of the RF source.

Response Block. The response block keys and softkey menus control the measurement and display functions specific to the active channel.

Instrument State Block. These keys allow access to major instrument modes of operation shown below. The external source, tuned receiver, and frequency offset modes are described in Chapter 14.

- Network Analyzer Mode (standard analyzer operating mode).
- External Source Mode – Allows phase lock to an external CW signal.
- Tuned Receiver Mode – Turns off phase locking circuitry, allows use of internal or external source.
- Frequency Offset Mode – Allows phase-locked operation for testing a frequency translating DUT such as a mixer. An external local oscillator is required.

The instrument state keys control channel-independent system functions such as copying, save/recall, HP-IB controller mode, limit testing, time domain transform (option 010) functions, 6 GHz mode (option 006), and the test sequence function.

The 6 GHz mode can only be used with HP 8753C Option 006 instruments, and then only if used with an HP 85047A 6 GHz S-parameter Test Set. 6 GHz mode is explained in Chapter 14.

The test sequence function allows the operator to enter the keystrokes required for any given measurement, and then execute the entire test by pressing a single key. Test sequencing may also be configured to run automatically at power on. Chapter 13 describes this feature.

HP-IB Control

The functions accessible from the front panel can also be accessed remotely by an external controller using HP-IB. Equivalent HP-IB commands are available for most of the front panel keys and softkey menu selections. The HP-IB programming command equivalent to each front panel and softkey function is provided in parentheses after the first reference. Additional information about HP-IB programming is provided in chapter 11.

Information on Keys and Softkeys

The following chapters describe all the front panel keys and softkey menus in detail. The purpose and use of each function is detailed, together with expected indications and results, allowable values, and possible limitations. This information is presented in function block order. Each function block is illustrated and described in general terms. This is followed by information about each front panel key in the function block, together with a map and description of all the menus accessed from that key. Each menu is illustrated, and each softkey function in each menu is explained in detail. A complete map of the softkey menu structure is provided in Appendix A at the end of this reference, together with an alphabetical index.

FRONT PANEL FEATURES

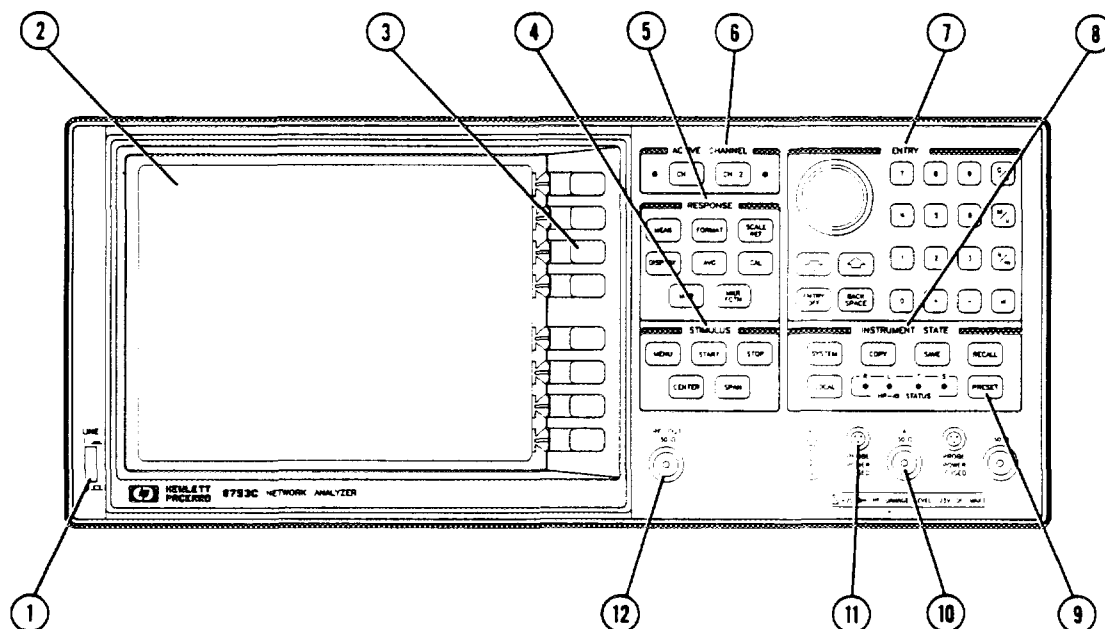

Figure 2-1. HP 8753C Front Panel

Figure 2-1 illustrates the following features and function blocks of the analyzer front panel. These features are described in more detail in this and subsequent chapters. Instructions for removal and cleaning of the CRT filter are provided in the *Operator's Check* section of this manual.

1. LINE switch. This controls AC power to the analyzer. 1 is on, 0 is off.
2. CRT display. This is used for display of data traces, measurement annotation, softkey labels, and other information. The display is divided into specific information areas, illustrated in Figure 2-2.
3. Softkeys. These keys expand the capabilities of the analyzer with additional functions beyond those of the front panel keys. They provide access to menu selections displayed on the CRT.
4. STIMULUS function block. The keys in this block are used to control the RF signal from the analyzer's source, and other stimulus functions.
5. RESPONSE function block. The keys in this block are used to control the measurement and display functions of the active display channel.
6. ACTIVE CHANNEL keys. The analyzer has two independent display channels. These keys are used to select the active channel. Any functions then entered apply to this active channel.
7. The ENTRY block includes the knob, the step [▲][▼] keys, and the number pad. These are used for entering numerical data and controlling the marker.

8. **INSTRUMENT STATE** function block. These keys are used to control channel-independent system functions such as the following:

- Copying, save/recall, and HP-IB controller mode.
- Limit testing.
- External source mode.
- Tuned receiver mode.
- Frequency offset mode.
- Test sequence function.
- Time domain transform (option 010).
- Harmonic Measurements (option 002).
- 6 GHz mode (option 006).

Also included in this block are the HP-IB STATUS indicators.

9. **[PRESET]** key. This key returns the instrument to a known standard preset state from any step of any manual procedure. A complete listing of the instrument preset condition is provided in Appendix A.
10. Network analyzer inputs R, A, and B. These are used to receive input signals from a test set, source, or device under test. Input R is used as the reference input, and a portion of the RF output signal must be routed to input R for proper phase-locked operation. The exception to this is when using tuned receiver mode. This mode is not phase-locked, and the signal may be input directly into the R, A, or B inputs. Inputs A or B are preferred because they offer greater dynamic range.
11. **PROBE POWER** connector. This connector (fused inside the instrument) supplies power to an active probe for in-circuit measurements of AC circuits.
12. **RF OUT** connector. This connects the RF output signal from the analyzer's internal source to a test set or power splitter.

CRT DISPLAY

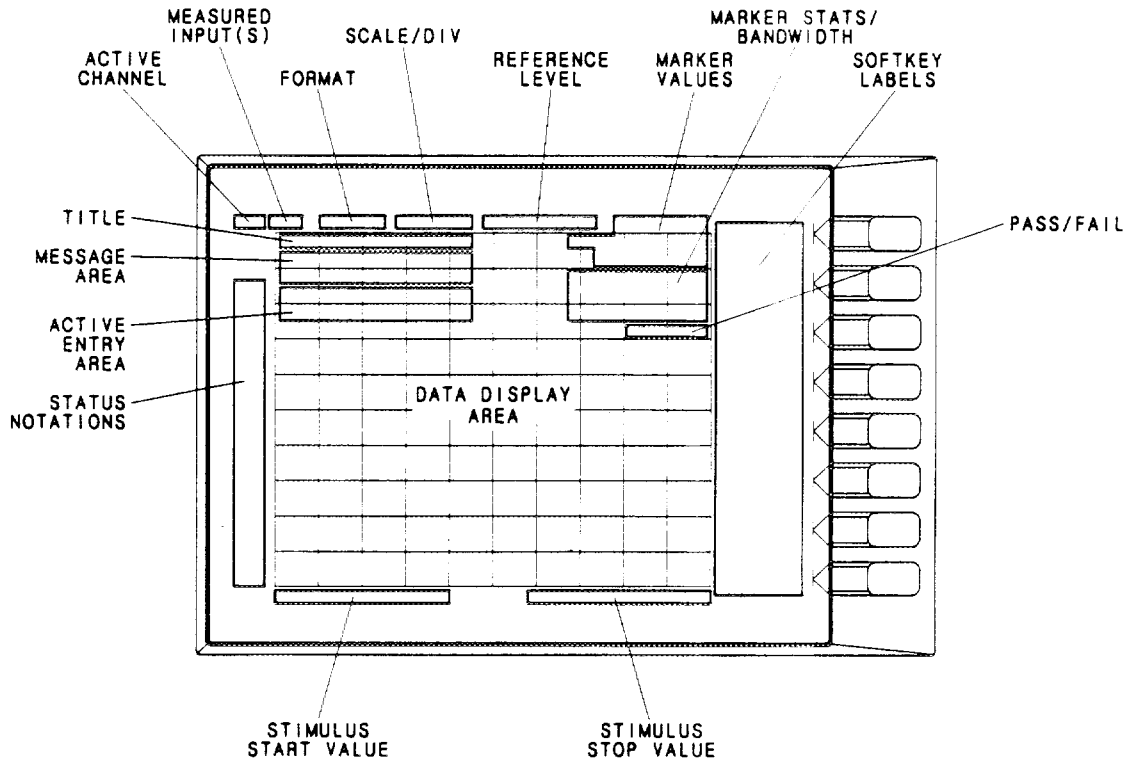

Figure 2-2. CRT Display (Single Channel, Cartesian Format)

The CRT displays the grid on which the measurement data is plotted, the currently selected measurement traces, and other information describing the measurement. Figure 2-2 illustrates the locations of the different CRT information labels, described below.

In addition to the full-screen display shown in Figure 2-2, a split display is available, as described under *[DISPLAY] Key, Display More Menu* in Chapter 4. In this case, information labels are provided for each half of the display.

Several different display formats for different measurements are illustrated and described in Chapter 4, under *[FORMAT] Key*.

Stimulus Start Value is the start frequency of the source in frequency domain measurements, the start time in CW mode (0 seconds) or time domain measurements, or the lower power value in power sweep. When the stimulus is in center/span mode, the center stimulus value is shown in this space.

Stimulus Stop Value is the stop frequency of the source in frequency domain measurements, the stop time in time domain measurements or CW sweeps, or the upper limit of a power sweep. When the stimulus is in center/span mode, the span is shown in this space. The stimulus values can be blanked, as described under *[DISPLAY] Key, Display More Menu*.

(For CW time and power sweep measurements, the CW frequency is displayed centered between the start and stop times or power values.)

Status Notations is the area used to show the current status of various functions for the active channel. The following notations are used:

- Avg = Sweep-to-sweep averaging is on. The averaging count is shown immediately below (see Chapter 4, [AVG] Key).
- Cor = Error correction is on (see Chapter 5).
- C? = Stimulus parameters have changed, or interpolated error correction is on. (see Chapter 5, [CAL] Key).
- C2 = Two-port error correction is on (see Chapter 5).
- C2? = Two-port error correction is on, but stimulus parameters have changed.
- Del = Electrical delay has been added or subtracted (see Chapter 4, [SCALE REF] Key).
- x2 = 6 GHz mode is on (6 GHz receiver operation, option 006 only) (see Chapter 14).
- x2? = 6 GHz mode is on, but the user has changed the power setting. System performance is no longer specified (6 GHz receiver operation, option 006 only) (see Chapter 14).
- Ext = Waiting for an external trigger.
- OFs = Frequency offset mode is on (see Chapter 14).
- OF? = Frequency offset mode error, the IF frequency is not within 10 MHz of expected frequency. LO inaccuracy is the most likely cause (see Chapter 14).
- Gat = Gating is on (time domain option 010 only) (see Chapter 8).
- H=2 = Harmonic mode is on, and the second harmonic is being measured. (harmonics option 002 only) (see Chapter 14).
- H=3 = Harmonic mode is on, and the third harmonic is being measured. (harmonics option 002 only) (see Chapter 14).
- Hld = Hold sweep (see Chapter 3, *Trigger Menu*).
- man = Waiting for manual trigger.
- PC = Power meter calibration is on. (Refer to Chapter 5, [CAL] key)
- PCo = Power has been offset from the original power meter calibration sweep. (see Chapter 5).
- PC? = The analyzer's source is in saturation. Power meter calibration is requesting more power than the internal source can supply. (see Chapter 5).
- P? = Source power is unlevelled at start or stop of sweep. (Refer to the *On-Site Service Manual* for troubleshooting.)
- P↓ = Source power has been automatically set to minimum due to overload (see Chapter 3, *Power Menu*).
- Smo = Trace smoothing is on (see Chapter 4, [AVG] Key).
- tsH = Applies only to systems equipped with an S-parameter test set. "tsH" indicates that the test set hold mode is engaged – the user has selected a mode of operation which would cause repeated switching of either the test port transfer switch or step attenuator. This hold mode may be overridden by either the [MEASURE RESTART] or [NUMBER OF GROUPS] softkeys, described in Chapter 3, *Stimulus Function Block*.
- ↑ = Fast sweep indicator. This symbol is displayed in the status notation block when sweep time is less than 1.0 second. When sweep time is greater than 1.0 second, this symbol moves along the displayed trace.
- * = Source parameters changed: measured data in doubt until a complete fresh sweep has been taken

Active Entry Area displays the active function and its current value.

Message Area displays prompts or error messages.

Title is a descriptive alpha-numeric string title defined by the user and entered as described under [DISPLAY] Key, *Title Menu*. (In HP-IB, the title block is replaced by HP-IB commands entered from the external controller, if the special debug mode is on.) Refer to Chapter 11.

Active Channel is the number of the current active channel, selected with the **[ACTIVE CHANNEL]** keys. If dual channel is on with an overlaid display, both channel 1 and channel 2 appear in this area.

Measured Input(s) shows the S-parameter, input, or ratio of inputs currently measured, as selected using the **[MEAS]** key. Also indicated in this area is the current display memory status.

Format is the display format selected using the **[FORMAT]** key.

Scale/Div is the scale selected using the **[SCALE/REF]** key, in units appropriate to the current measurement.

Reference Level is the value of a reference line in Cartesian formats or the outer circle in polar formats, selected using the **[SCALE/REF]** key. The reference level is also indicated by a small triangle adjacent to the graticule, at the left for channel 1 and at the right for channel 2.

Marker Values are the values of the active marker, in units appropriate to the current measurement. Refer to *Using Markers*, in Chapter 6 of this section.

Marker Stats, Bandwidth are statistical marker values determined using the menus accessed with the **[MKR FCTN]** key. Refer to *Using Markers*.

Softkey Labels are menu labels displayed on the CRT that redefine the function of the softkeys immediately to the right of the CRT.

NOTE: The information provided here applies to Cartesian formats. In polar and Smith chart formats labeling may differ.

ACTIVE CHANNEL KEYS

The analyzer has two digital channels for independent measurement and display of data. Two different sets of data can be measured simultaneously, for example the reflection and transmission characteristics of a device, or one measurement with two different frequency spans. The data can be displayed separately or simultaneously, as described below. The HP-IB programming command is shown in parenthesis following the key or softkey.

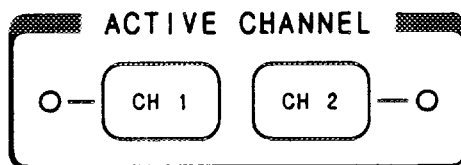

Figure 2-3. Active Channel Keys

The **[CH 1]** (CHAN1) and **[CH 2]** (CHAN2) keys illustrated in Figure 2-3 are used to select one channel to be the "active channel". This is the channel currently controlled by the front panel keys, and its trace and data annotations are displayed on the CRT. All channel-specific functions selected apply to the active channel. The current active channel is indicated by an amber LED adjacent to the corresponding channel key.

The analyzer has dual trace capability, so that both the active and inactive channel traces can be displayed, either overlaid or on separate graticules one above the other (split display). The dual channel and split display features are available in the display menus. Refer to Chapter 4 for illustrations and descriptions of the different display capabilities.

Source values can be coupled or uncoupled between the two channels, independent of the dual channel and split display functions. Refer to *Stimulus Menu* in Chapter 3 for a listing of the source values that are coupled in stimulus coupled mode.

A third coupling capability is coupled markers. Measurement markers can have the same stimulus values for the two channels, or they can be uncoupled for independent control in each channel. Refer to Chapter 6 for more information about markers.

ENTRY BLOCK KEYS

The ENTRY block, illustrated in Figure 2-4, provides the numeric and units keypad, the knob, and the step keys. These are used in combination with other front panel keys and softkeys to modify the active entry, to enter or change numeric data, and to change the value of the active marker. In general the keypad, knob, and step keys can be used interchangeably.

Before a function can be modified, it must be made the active function by pressing a front panel key or softkey. It can then be modified directly with the knob, the step keys, or the digits keys and a terminator, as described below.

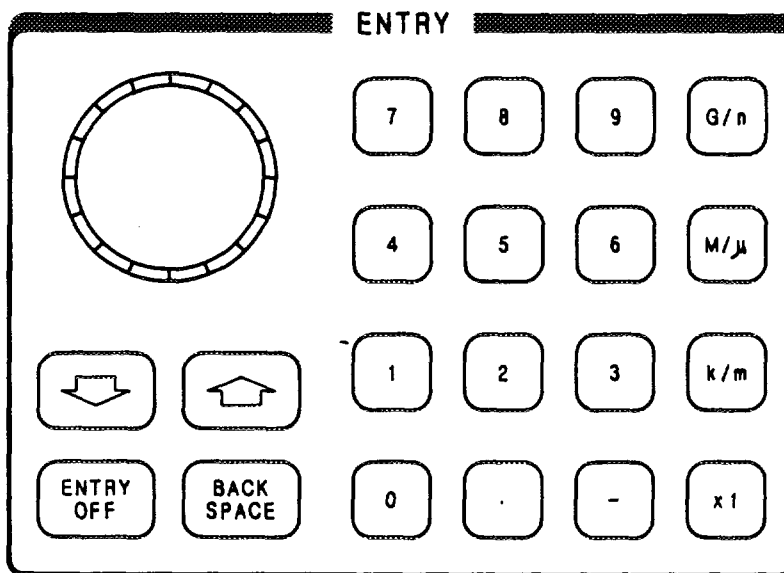



Figure 2-4. Entry Block

The numeric keypad is used to select digits, decimal point, and minus sign for numerical entries. A units terminator is required, as described below. The HP-IB programming command is shown in parenthesis following the key or softkey.

The units terminator keys are the four keys in the right-hand column of the keypad. These are used to specify units of numerical entries from the keypad and at the same time terminate the entries. A numerical entry is incomplete until a terminator is supplied, and this is indicated by the data entry arrow ← pointing at the last entered digit in the active entry area. When the units terminator key is pressed, the arrow is replaced by the units selected. The units are abbreviated on the terminator keys as follows:

[G/n] (G, N)	=	Giga/nano ($10^9 / 10^{-9}$)
[M/μ] (M, U)	=	Mega/micro ($10^6 / 10^{-6}$)
[k/m] (K, M)	=	kilo/milli ($10^3 / 10^{-3}$)
[x1] (HZ, S, DB, V)	=	basic units: dB, dBm, degrees, seconds, Hz, or dB/GHz (may be used to terminate unitless entries such as averaging factor)

The knob is used to make continuous adjustments to current values for various functions such as scale, reference level, and others. If there is a marker turned on, and no other function is active, the knob can be used to adjust the marker stimulus values. Values changed by the knob are effective immediately, and require no units terminator.

The step keys [] (UP) and [] (DOWN) are used to step the current value of the active function up or down. The steps are defined by the analyzer for different functions and cannot be altered. No units terminator is required. For editing a test sequence, these keys allow you to scroll through the displayed sequence.

[ENTRY OFF] (ENTO) clears and turns off the active entry area, as well as any displayed prompts, error messages, or warnings. Use this function to clear the display before plotting. Another purpose of this softkey is to prevent changing of active values by accidentally moving the knob. The next selected function turns the active entry area back on.

[BACK SPACE] deletes the last entry, or the last digit entered from the numeric keypad. For modifying a test sequence, the backspace key may be used in one of two ways:

- If pressed when modifying a single-key command like **[A/R]**, the backspace key deletes the command.
- If pressed when entering a number like **[START] [1] [2]**, and you have not yet pressed a terminator key (**[G/n]**, etc), the backspace key will delete the last digit (in this example the 2 will be deleted).

REAR PANEL FEATURES AND CONNECTORS

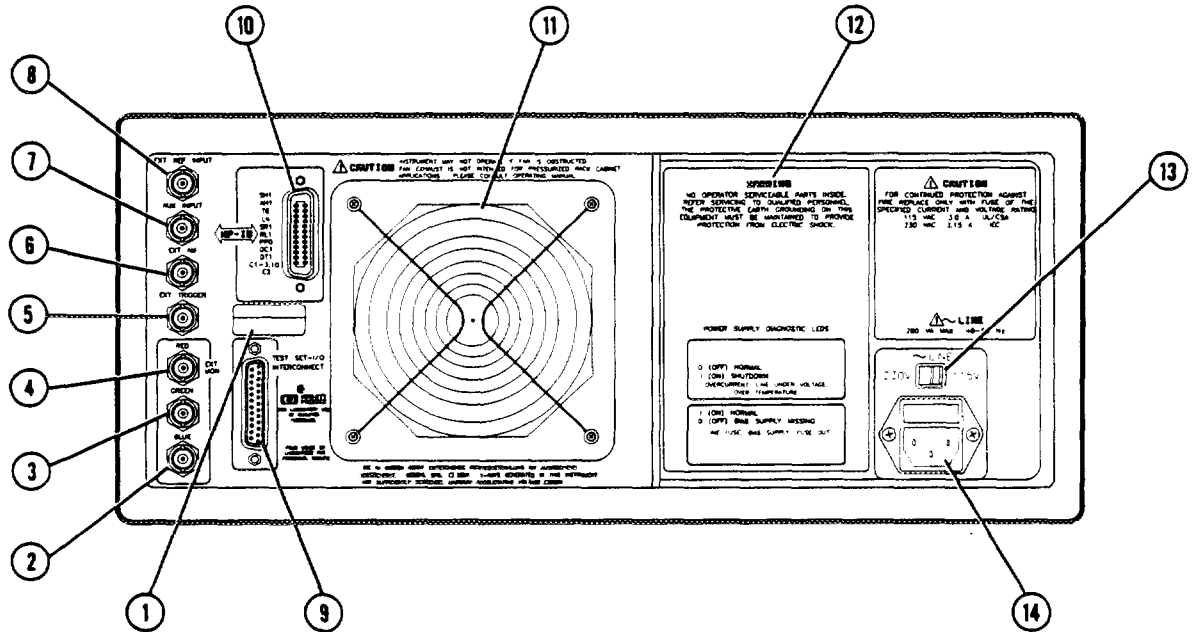

Figure 2-5. HP 8753 Rear Panel

Figure 2-5 illustrates the features and connectors of the rear panel, described below. Requirements for input signals to the rear panel connectors are provided in the *General Characteristics* table of the *General Information and Specifications* section.

1. Serial number plate. For information about serial numbers, refer to *Instruments Covered by Manual* in the *General Information and Specifications* section.
2. BLUE connector.
3. GREEN connector.
4. RED connector. Red, green, and blue video output connectors provide analog red, green, and blue video signals which can be used to drive an external monitor such as the HP 3571A/B or monochrome monitor such as the HP 35731A/B. Other analog multi-sunc monitors can be used if they are compatible with the analyzer's 25.5 KHz scan rate and video levels: 1vp—p, 0.7v=white, 0v=black, -0.3v sync, sync on green.
5. EXT TRIGGER connector. This is used to connect an external negative-going TTL-compatible signal to trigger a measurement sweep. The trigger can be set to external through softkey functions (see Chapter 3, *Trigger Menu*).
6. EXT AM connector. This is used to connect an external analog signal to the ALC circuitry of the analyzer's source to amplitude modulate the RF output signal.
7. AUX INPUT connector. This is used to connect a DC or AC voltage from an external signal source such as a detector or function generator, which can then be displayed and measured using the S-parameter menu. (It is also used as an analog output in service routines, as described in the service manual.)

8. EXT REF INPUT connector. This is used to input a frequency reference signal to phase lock the analyzer to an external frequency standard for increased frequency accuracy.

The external frequency reference feature is automatically enabled when a signal is connected to this input. When the signal is removed, the analyzer automatically switches back to its internal frequency reference.

9. TEST SET INTERCONNECT. This is used to connect the analyzer to an HP 85046A/B or 85047A S-parameter test set using the interconnect cable supplied with the test set. The S-parameter test set is then fully controlled by the analyzer. The HP 85044A/B transmission/reflection test set does not use this interconnection.
10. HP-IB connector. This is used to connect the analyzer to an external controller and other instruments in an automated system. This connector is also used when the analyzer itself is the controller of compatible peripherals. Refer to *HP-IB Considerations* in the *System Installation* section of this manual for information and limitations. Information on different controller modes is provided in Chapter 7 under *Instrument State Function Block, [LOCAL] Key*.
11. Fan. This fan provides forced-air cooling for the analyzer.
12. Safety warnings.
13. Line voltage selector switch. For more information refer to *Line Voltage and Fuse Selection* in the *User's Guide* in this manual.
14. Power cord receptacle, with fuse. For information on replacing the fuse, refer to the *User's Guide*.

Chapter 3. Stimulus Function Block

CHAPTER CONTENTS

- 3-1 Introduction
- 3-2 Test Set Attenuator, Test Port Transfer Switch, and Doubler Switch Protection
- 3-3 [START], [STOP], [CENTER], and [SPAN] Keys
- 3-4 [MENU] Key
- 3-5 Stimulus Menu
- 3-7 Power Menu
- 3-9 Trigger Menu
- 3-10 Sweep Type Menu
- 3-13 Single/All Segment Menu
- 3-14 Edit List Menu
- 3-15 Edit Sub sweep Menu

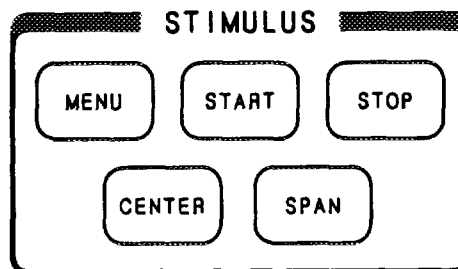

Figure 3-1. Stimulus Function Block

INTRODUCTION

The stimulus function block keys and associated menus are used to define and control the source RF output signal to the device under test. The source signal can be swept over any portion of the instrument's frequency and power range. The stimulus keys also control the start and stop times in the optional time domain mode. The menus are used to set all other source characteristics such as sweep time and resolution, source RF power level, the number of data points taken during the sweep, and S-parameter test set attenuation.

The HP-IB programming command is shown in parenthesis following the key or softkey.

TEST SET ATTENUATOR, TEST PORT TRANSFER SWITCH, AND DOUBLER SWITCH PROTECTION

Test Set Attenuator

The S-parameter test set contains a programmable step attenuator that is switched between port 1 and port 2. To avoid premature wearing out of the attenuator, measurement configurations requiring continuous switching are not allowed. The following example explains how the analyzer prevents continuous switching:

- Channels 1 and 2 of the analyzer are decoupled, different attenuation values are selected for each channel, and dual channel display is engaged. To prevent continuous switching between the two attenuation values, the analyzer automatically engages the test set hold mode. (The status annotation "tsH" appears on the left side of the CRT.) If averaging is on, the test set hold mode does not engage until the specified number of sweeps is completed. The **[MEASURE RESTART]** and **[NUMBER OF GROUPS]** softkeys, explained later, can override this protection feature.

Test Port Transfer Switch

An S-parameter test set can only send power to one test port at a time. A mechanical transfer switch in the test set sends power to either port 1 or port 2. To avoid premature wearing out of the transfer switch, measurement configurations requiring continuous switching are not allowed. The following examples explain how the analyzer prevents continuous switching:

- A full two-port calibration requires all four S-parameters be measured for each sweep. This would require the transfer switch to engage twice each sweep. To prevent continuous switching, only the first measurement uses the transfer switch to measure all four S-parameters. Subsequent sweeps do not use the switch and only two S-parameters are measured. The **[MEASURE RESTART]** and **[NUMBER OF GROUPS]** softkeys can override this protection feature and allow measurement of all four S-parameters.
- When port 1 and port 2 are driven by different channels and dual channel display is turned on, the transfer switch would switch repeatedly between channels. To prevent continuous switching, the analyzer automatically engages the test set hold mode. (The status annotation "tsH" appears on the left side of the CRT.) If averaging is on, the hold mode will not engage until the specified number of sweeps are completed. The **[MEASURE RESTART]** and **[NUMBER OF GROUPS]** softkeys can override this protection feature and allow switching to occur.

[MEASURE RESTART] and [NUMBER OF GROUPS] Softkeys

These softkeys allow measurements which demand repetitive switching of either the step attenuator or the test port transfer switch. Use these softkeys with caution, repetitive switching will cause premature wearing of the switches.

- **[MEASURE RESTART]** causes one measurement to occur.
- **[NUMBER OF GROUPS]** causes a specified number of measurements to occur.

These softkeys are explained in detail later in this chapter.

Doubler Switch Protection (HP 85047A)

The HP 85047A S-parameter Test Set uses a frequency doubler to switch between 3 and 6 GHz operation. Because the doubler uses a mechanical switch, operations which would require repetitive switching between the two modes are not permitted. For this reason, 6 GHz mode is either on or off for both channels. There is no override for this protective feature.

[START], [STOP], [CENTER], AND [SPAN] KEYS

The HP-IB programming command is shown in parenthesis following the key or softkey.

[START] (STAR)
[STOP] (STOP)
[CENTER] (CENT)
[SPAN] (SPAN)

Use these keys to define the frequency range or other horizontal axis range of the stimulus. The range can be expressed as either start/stop or center/span. When one of these keys is pressed, its function becomes the active function. The value is displayed in the active entry area and can be changed with the knob, step keys, or numeric keypad. Current stimulus values for the active channel are also displayed along the bottom of the graticule. Frequency values can be set to zero for security purposes, using the display menus.

The preset stimulus mode is frequency, and the start and stop stimulus values are set to 300 kHz and 3 GHz respectively. In the time domain (option 010) or in CW time mode, the stimulus keys refer to time (with certain exceptions that are explained in Chapter 8, *Time and Frequency Domain Transforms*). In power sweep, the stimulus value is in dBm.

Because the display channels are independent, the stimulus signals for the two channels can be uncoupled and their values set independently. The values are then displayed separately on the CRT if the instrument is in dual channel display mode. In the uncoupled mode with dual channel display the instrument takes alternate sweeps to measure the two sets of data. Channel stimulus coupling is explained in this chapter, and dual channel display capabilities are explained in Chapter 4, *Response Function Block*.

[MENU] KEY

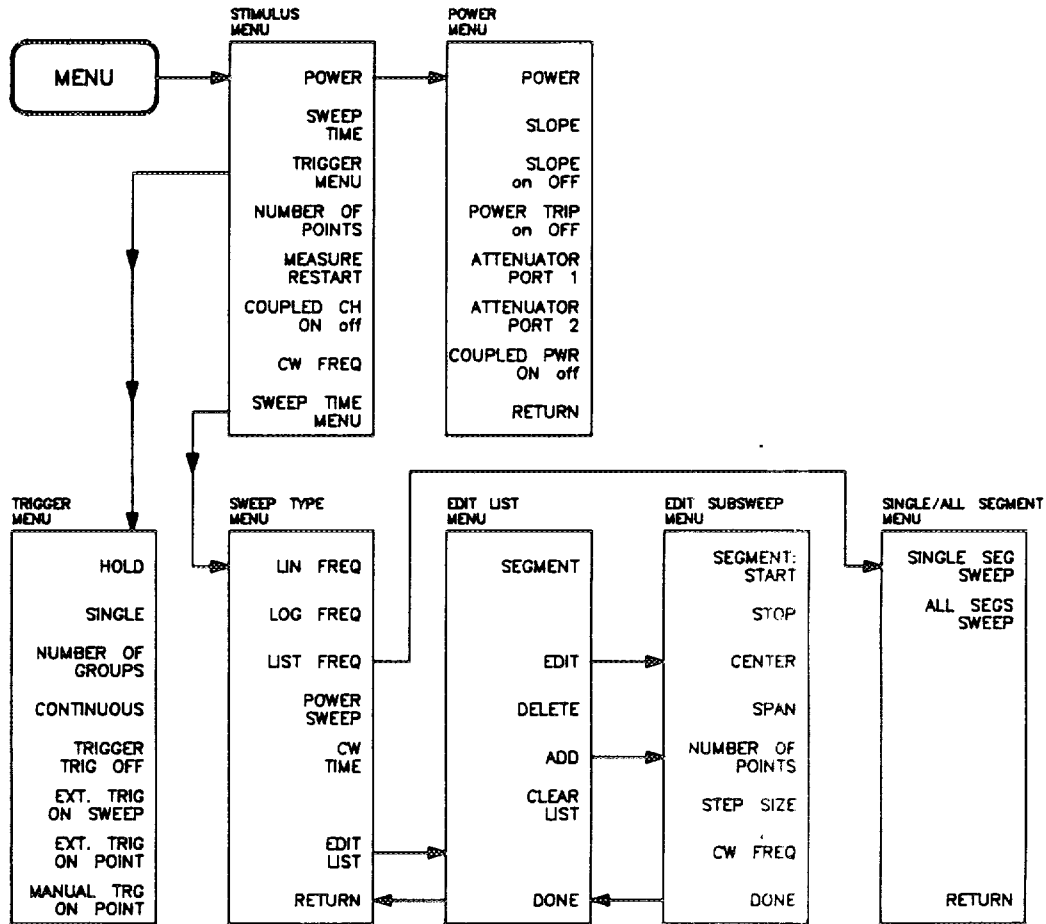

Figure 3-2. Softkey Menus Accessed from the [MENU] Key

The HP-IB programming command is shown in parenthesis following the key or softkey.

The [MENU] (MENUSTIM) key provides access to the series of menus illustrated in Figure 3-2, which are used to define and control all stimulus functions other than start, stop, center, and span. When the [MENU] key is pressed, the stimulus menu is displayed. This in turn provides access to the other illustrated softkey menus. The functions available in these menus are described in the following pages. VB9

Stimulus Menu

The stimulus menu is used to specify the sweep time, number of measurement points per sweep, and CW frequency. It includes the capability to couple or uncouple the stimulus functions of the two display channels, and the measurement restart function. In addition, it leads to other softkey menus that define power level, trigger type, and sweep type. The individual softkey functions of the stimulus menu are described below.

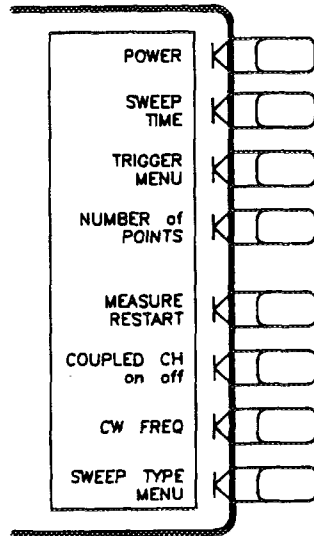

Figure 3-3. Stimulus Menu

[POWER] (POWE) makes power level the active function and presents the power menu, which is used to set the output power level and slope compensation of the source, and control the attenuator in an HP 85046A/B or 85047A programmable S-parameter test set.

[SWEEP TIME []] (SWET) toggles between automatic and manual sweep time. The following explains the difference between automatic and manual sweep time:

- **Manual Sweep Time.** As long as the selected sweep speed is within the capability of the instrument, it will remain fixed, regardless of changes to other measurement parameters. If the operator changes measurement parameters such that the instrument can no longer maintain the selected sweep time, the analyzer will change to the best sweep time possible.
- **Auto Sweep Time.** Auto sweep time continuously maintains the fastest sweep speed possible with the selected measurement parameters.

Sweep time refers only to the time that the instrument is sweeping and taking data, and does not include the time required for internal processing of the data. A sweep speed indicator ↑ is displayed on the trace for sweep times slower than 1.0 second. For sweep times faster than 1.0 second the ↑ indicator is displayed in the status notations area at the left of the CRT.

Minimum Sweep Time. The minimum sweep time is dependent on several factors. These factors are referred to as "measurement parameters" in the following paragraphs.

- The number of points selected.
- IF bandwidth.
- Sweep-to-sweep averaging in dual channel display mode.
- Smoothing.
- Limit lines.
- Error correction.
- Trace math.
- Marker statistics.
- Time domain.
- Type of sweep.

The following table is a partial guide for determining the minimum sweep time for the listed measurement parameters. The values listed represent the minimum time required for a CW time measurement with averaging off. Values are given in seconds.

Number of Points	IF Bandwidth			
	3000 Hz	1000 Hz	300 Hz	10 Hz
11	0.0055	0.012	0.036	1.14
51	0.0255	0.06	0.166	5.3
101	0.0505	0.12	0.328	10.5
201	0.1005	0.239	0.653	20.9
401	0.2005	0.476	1.303	41.7
801	0.4005	0.951	2.603	83.3
1601	0.8005	1.901	5.203	166.5

Sweep time may be used in manual or auto modes. These are explained below.

Manual Sweep Time Mode. When this mode is active, the softkey label reads **[SWEEP TIME [MANUAL]]**. This mode is engaged whenever the operator enters a sweep time greater than zero. This mode allows the operator to select a fixed sweep time. If the operator changes the measurement parameters such that the current sweep time is no longer possible, the analyzer will automatically decrease to the next fastest sweep time possible. If the measurement parameters are changed such that a faster sweep time is possible, the analyzer will not alter the sweep time while in this mode.

Auto Sweep Time Mode. When this mode is active, the softkey label reads **[SWEEP TIME [AUTO]]**. This mode is engaged whenever the operator enters **[0] [x1]** as a sweep time. Auto sweep time continuously maintains the fastest sweep time possible with the selected measurement parameters.

[TRIGGER MENU] presents the trigger menu, which is used to select the type and number of the sweep trigger.

[NUMBER OF POINTS] (POIN) is used to select the number of data points per sweep to be measured and displayed. Using fewer points allows a faster sweep time but the displayed trace shows less horizontal detail. Using more points gives greater data density and improved trace resolution, but slows the sweep and requires more memory for error correction or saving instrument states.

The possible values that can be entered for number of points are 3, 11, 26, 51, 101, 201, 401, 801, and 1601. The number of points can be different for the two channels if the stimulus values are uncoupled.

In list frequency sweep, the number of points displayed is the total number of frequency points for the defined list (see *Sweep Type Menu*).

[MEASURE RESTART] (REST) aborts the sweep in progress, then restarts the measurement. This can be used to update a measurement following an adjustment of the device under test. When a full two-port calibration is in use, the **[MEASURE RESTART]** key will initiate another update of both forward and reverse S-parameter data. This softkey will also override the test set hold mode, which inhibits continuous switching of either the test port transfer switch or step attenuator. The measurement configurations which cause this are described in *Test Set Attenuator*, *Test Port Transfer Switch*, and *Doubler Switch Protection*, at the beginning of this section. This softkey will override the test set hold mode for one measurement.

If the analyzer is taking a number of groups (see *Trigger Menu*), the sweep counter is reset at 1. If averaging is on, **[MEASURE RESTART]** resets the sweep-to-sweep averaging and is effectively the same as **[AVERAGING RESTART]**. If the sweep trigger is in **[HOLD]** mode, **[MEASURE RESTART]** executes a single sweep.

[COUPLED CH on OFF] (COUCON, COUCOFF) toggles the channel coupling of stimulus values. With **[COUPLED CH ON]** (the preset condition), both channels have the same stimulus values (the inactive channel takes on the stimulus values of the active channel).

In the stimulus coupled mode, the following parameters are coupled:

- Frequency.
- Source power.
- Power slope.
- Sweep time.
- Trigger type.
- Sweep type.
- Power meter calibration.
- Number of points.
- Number of groups.
- IF bandwidth.
- Time domain transform.
- Gating.
- Harmonic measurement.

Coupling of stimulus values for the two channels is independent of **[DUAL CHAN on OFF]** in the display menu and **[MARKERS: UNCOUPLED]** in the marker mode menu. **[COUPLED CH OFF]** becomes an alternate sweep function when dual channel display is on: in this mode the analyzer alternates between the two sets of stimulus values for measurement of data and both are displayed.

[CW FREQ] (CWFREQ) is used to set the frequency for power sweep and CW time sweep modes. If the instrument is not in either of these two modes, it is automatically switched into CW time mode.

[SWEEP TYPE MENU] presents the sweep type menu, where one of the available types of stimulus sweep can be selected.

Power Menu

The power menu is used to set the output power level of the source, to set power slope to compensate for measured power loss with frequency, and to control the programmable attenuator in an HP 85046A/B or 85047A S-parameter Test Set.

Power Output During 6 GHz Operation. When the HP 8753C Option 006 and HP 85047A 6 GHz test set are used together in a system, the 6 GHz mode may be engaged. In this mode, the analyzer sets the RF output power to +20 dBm. This is the power level which allows optimum performance of the 6 GHz test set. Limited changes to power level may be allowed: refer to Chapter 14. If the system is changed back to the 3 GHz mode, the RF power output of the analyzer automatically changes to 0 dBm.

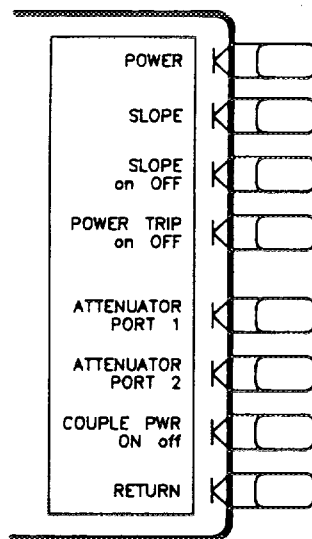

Figure 3-4. Power Menu

[POWER] (POWE) makes power level the active function and sets the RF output power level of the analyzer's internal source. The analyzer will detect an input power overload at any of the three receiver inputs, and automatically reduce the output power of the source to -5 dBm. This is indicated with the message "OVERLOAD ON INPUT (R, A, B)." In addition, the **[POWER TRIP ON]** flag (see below) is set, and the annotation "P↓" appears at the left side of the CRT. When this occurs, toggle the power trip off and reset the power at a lower level.

If the source power is unlevelled at the start or stop of a sweep, the notation "P?" is displayed at the left of the CRT. This indicates that the automatic leveling control circuit of the source is unable to keep the source power leveled to instrument specifications, and the power is therefore potentially uncalibrated. The "P?" notation is removed only after a sweep in which the source power is detected to be leveled at both the start and stop of the sweep. Refer to the *On-Site System Service Manual* for troubleshooting information.

[SLOPE] (SLOPE) compensates for power loss versus the frequency sweep, by sloping the output power upwards proportionally to frequency. Use this softkey to enter the power slope in dB per GHz of sweep.

[SLOPE on OFF] (SLOPON, SLOPOFF) toggles the power slope function on or off. With slope on, the output power increases with frequency, starting at the selected power level.

[POWER TRIP on OFF] (POWTON, POWTOFF) toggles the power trip function on or off. Power trip is a reduced power state triggered by a power overload. It forces the source output power to -5 dBm regardless of the user-specified power level. The trip is set automatically whenever a power overload is detected on an input channel. When trip is on, the annotation "P↓" appears in the status notations area of the display.

To reset the power level following a power trip, toggle the power trip OFF

[ATTENUATOR PORT 1] (ATTP1) controls the attenuation at port 1 of an HP 85046A/B or 85047A S-parameter Test Set connected to the analyzer. The attenuator range is 0 to 70 dB, controllable in 10 dB steps. Attenuation is used to reduce the signal level at the test port without reducing the reference signal, for example to perform measurements of amplifiers.

The S-parameter test set must be interfaced with the analyzer through the test set interconnect cable for the attenuator control signal to be enabled. Note that no warning is given if no test set is present, or if the test set has no programmable attenuator (as in the HP 85044A/B Transmission/Reflection Test Set).

[ATTENUATOR PORT 2] (ATTP2) serves the same function for the attenuation at port 2 of the HP 85046A/B or 85047A S-parameter Test Set.

NOTE: The analyzer does not allow port 1 and 2 to be set to different attenuator values. This is required because the same attenuator is used for both ports, and is mechanically switched between them. To prevent premature wearing out, continuous switching of attenuator values between ports is not allowed.

[COUPLE PWR ON off] (COUPON COUPOFF) is intended for use with the **[D2/D1 to D2 on OFF]** softkey. The D2/D1 to D2 function is used in harmonic measurements, where the fundamental is displayed on channel 1 and the harmonic on channel 2. D2/D1 to D2 ratios the two, displaying the fundamental and relative power of the measured harmonic in dBc. When making such measurements, channel 1 and 2 must be uncoupled with the **[COUPLED CHAN ON off]** softkey set to OFF to allow alternating sweeps.

After uncoupling channel 1 and 2, the operator may wish to change the power level of the fundamental and see resultant change in relative harmonic power (in dBc). **[COUPLE PWR ON off]** allows the operator to change the power of both channels simultaneously (coupled power), even though they are uncoupled in all other respects.

Turning **[COUPLE PWR ON off]** off can uncouple power only if channels 1 and 2 are uncoupled.

[RETURN] goes back to the stimulus menu.

Trigger Menu

This menu is used to select the type and number of the sweep trigger.

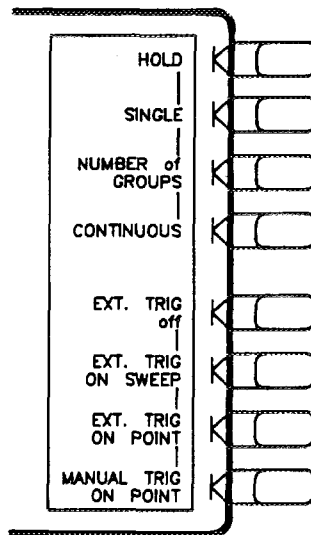

Figure 3-5. Trigger Menu

[HOLD] (HOLD) freezes the data trace on the display, and the analyzer stops sweeping and taking data. The notation "Hld" is displayed at the left of the graticule. If the * indicator is on at the left side of the CRT, trigger a new sweep with **[SINGLE]**.

[SINGLE] (SING) takes one sweep of data and returns to the hold mode.

[NUMBER OF GROUPS] (NUMG) triggers a user-specified number of sweeps, and returns to the hold mode. This function can be used to override the test set hold mode, which protects the electro-mechanical transfer switch and attenuator against continuous switching. This is explained fully in the *Test Set Attenuator, Test Port Transfer Switch, and Double Switch Protection* description in the beginning of this chapter.

If averaging is on, the number of groups should be at least equal to the averaging factor selected to allow measurement of a fully averaged trace. Entering a number of groups resets the averaging counter to 1.

[CONTINUOUS] (CONT) is the standard sweep mode of the analyzer, in which the sweep is triggered automatically and continuously and the trace is updated with each sweep.

[TRIGGER: TRIG OFF] (EXTTOFF) turns off external trigger mode.

[EXT TRIG ON SWEEP] (EXTTON) is used when the sweep is triggered on an externally generated signal connected to the rear panel EXT TRIGGER input. The sweep is started with a high-to-low transition of a TTL signal. If this key is pressed when no external trigger signal is connected, the notation "Ext" is displayed at the left side of the CRT to indicate that the analyzer is waiting for a trigger. When a trigger signal is connected, the "Ext" notation is replaced by the sweep speed indicator ↑ either in the status notations area or on the trace. External trigger mode is allowed in every sweep mode.

[EXT TRIG ON POINT] (EXTTPOIN) is similar to the trigger on sweep, but triggers each data point in a sweep.

[MANUAL TRG ON POINT] (MANTRIG) waits for a manual trigger for each point. Subsequent pressing of this softkey triggers each measurement. The annotation "man" will appear at the left side of the CRT when the instrument is waiting for the trigger to occur. This feature is useful in a test sequence when an external device or instrument requires changes at each point.

Sweep Type Menu

Five sweep types are available:

- Linear frequency sweeps in Hz. In the linear frequency sweep mode it is possible, with option 010, to transform the data for time domain measurements using the inverse Fourier transform technique.
- Logarithmic frequency sweeps in Hz.
- Power sweeps in dBm.
- CW time sweep in seconds. In the CW time sweep mode, the data can be transformed for frequency domain measurements. Refer to Chapter 8 for detailed information about time domain transform with option 010.
- List frequency sweep in Hz. A new feature is the single segment mode, where any single segment in a frequency list may be selected. The single segment will retain the same error correction as the original list of frequencies.

Interpolated Error Correction. The interpolated error correction feature will function with the following sweep types:

- Linear frequency
- Power sweep
- CW time

Interpolated error correction will not work in log or list sweep modes. Refer to Chapter 5 for more information on interpolated error correction.

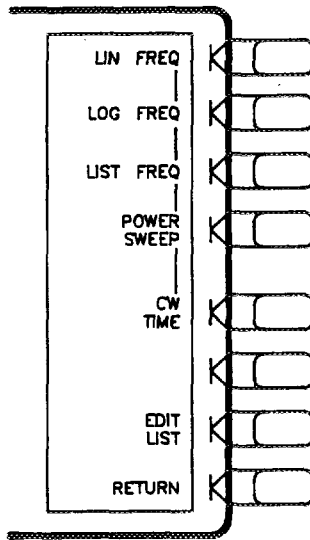

Figure 3-6. Sweep Type Menu

[LIN FREQ] (LINFREQ) activates a linear frequency sweep displayed on a standard graticule with ten equal horizontal divisions. This is the default preset sweep type.

For a linear sweep, sweep time is combined with the channel's frequency span to compute a source sweep rate:

$$\text{sweep rate} = (\text{frequency span}) / (\text{sweep time})$$

Since the sweep time may be affected by various factors (see *Stimulus Menu*), the equation provided here is merely an indication of the ideal (maximum) sweep rate. If the user-specified sweep time is greater than 15 ms times the number of points, the sweep changes from a continuous ramp sweep to a stepped CW sweep. Also, for narrow IF bandwidths the sweep is automatically converted to a stepped CW sweep.

[LOG FREQ] (LOGFREQ) activates a logarithmic frequency sweep mode. The source is stepped in logarithmic increments and the data is displayed on a logarithmic graticule. This is slower than a continuous sweep with the same number of points, and the entered sweep time may therefore be changed automatically. For frequency spans of less than two octaves, the sweep type automatically reverts to linear sweep.

[LIST FREQ] (LISTFREQ) provides a user-definable arbitrary frequency list mode. This list is defined and modified using the edit list menu and the edit subsweep menu. Up to 30 frequency subsweeps (called "segments") of several different types can be specified, for a maximum total of 1632 points. One list is common to both channels. Once a frequency list has been defined and a measurement calibration performed on the full frequency list, one or all of the frequency segments can be measured and displayed without loss of calibration.

When the **[LIST FREQ]** key is pressed, the network analyzer sorts all the defined frequency segments into CW points in order of increasing frequency. It then measures each point and displays a single trace that is a composite of all data taken. If duplicate frequencies exist, the analyzer makes multiple measurements on identical points to maintain the specified number of points for each subsweep. Since the frequency points may not be distributed evenly across the CRT, the display resolution may be uneven, and more compressed in some parts of the trace than in others. However, the stimulus and response readings of the markers are always accurate. Because the list frequency sweep is a stepped CW sweep, the sweep time is slower than for a continuous sweep with the same number of points.

The **[LIST FREQ]** softkey presents the segment menu, which allows the operator to select any single segment in the frequency list. Refer to *Edit List Menu* and *Edit Subsweep Menu* later in this chapter to see how to enter or modify the list frequencies. If no list has been entered, the message "CAUTION: LIST TABLE EMPTY" is displayed.

A tabular printout of the frequency list data can be obtained using the **[LIST VALUES]** function in the copy menu.

[POWER SWEEP] (POWS) turns on a power sweep mode that is used to characterize power-sensitive circuits. In this mode, power is swept at a single frequency, from a start power value to a stop power value, selected using the **[START]** and **[STOP]** keys and the entry block. This feature is convenient for such measurements as gain compression or AGC (automatic gain control) slope. To set the frequency of the power sweep, use **[CW FREQ]** in the stimulus menu. Refer to the *User's Guide* for an example of a gain compression measurement.

Note that the attenuator switch in the S-parameter test set is not switched in power sweep mode.

In power sweep, the entered sweep time may be automatically changed if it is less than the minimum required for the current configuration (number of points, IF bandwidth, averaging, etc.).

[CW TIME] (CWTIME) turns on a sweep mode similar to an oscilloscope. The analyzer is set to a single frequency, and the data is displayed versus time. The frequency of the CW time sweep is set with **[CW FREQ]** in the stimulus menu. In this sweep mode, the data is continuously sampled at precise, uniform time intervals determined by the sweep time and the number of points minus 1. The entered sweep time may be automatically changed if it is less than the minimum required for the current instrument configuration.

In time domain using option 010, the CW time mode data is translated to frequency domain, and the x-axis becomes frequency. This can be used like a spectrum analyzer to measure signal purity, or for low frequency (>1 kHz) analysis of amplitude or pulse modulation signals. For details, refer to Chapter 8.

[EDIT LIST] presents the edit list menu. This is used in conjunction with the edit subsweep menu to define or modify the frequency sweep list. The list frequency sweep mode is selected with the **[LIST FREQ]** softkey described above.

[RETURN] goes back to the stimulus menu.

Single/All Segment Menu

When this menu is presented, the frequency list table is displayed in the center of the CRT. A segment can then be selected to be measured, and the choice of a full-trace measurement or a single-segment measurement can be made.

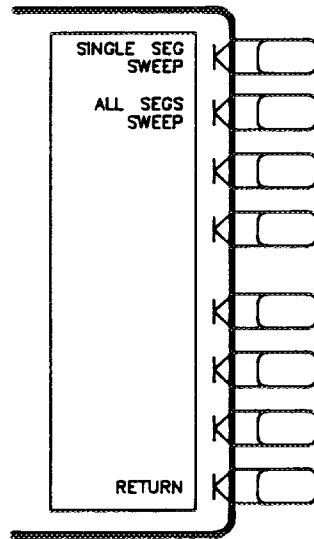

Figure 3-7. Single/All Segment Menu

[SINGLE SEG SWEEP] (SSEG) enables a measurement of a single segment of the frequency list, without loss of calibration. The segment to be measured is selected using the entry block.

In single segment mode, selecting a measurement calibration will force the full list sweep before prompting for calibration standards. The calibration will then be valid for any single segment.

If an instrument state is saved in memory with a single-segment trace, a recall will re-display that segment while also recalling the entire list.

[ALL SEGS SWEEP] (ASEG) retrieves the full frequency list sweep.

[RETURN] goes back to the sweep type menu

Edit List Menu

This menu is used to edit the list of frequency segments (subsweeps) defined with the edit subsweep menu, described next. Up to 30 frequency subsweeps can be specified, for a maximum of 1632 points. The segments do not have to be entered in any particular order: the analyzer automatically sorts them and lists them on the CRT in increasing order of start frequency. This menu determines which entry on the list is to be modified, while the edit subsweep menu is used to make changes in the frequency or number of points of the selected entry.

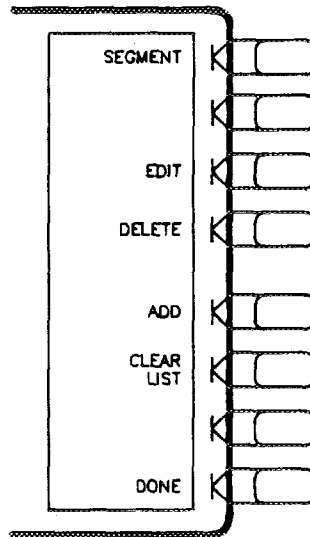

Figure 3-8. Edit List Menu

[SEGMENT] determines which segment on the list is to be modified. Enter the number of a segment in the list, or use the step keys to scroll the pointer > at the left to the required segment number. The indicated segment can then be edited or deleted.

[EDIT] goes to the edit subsweep menu, where the segment indicated by the pointer > at the left can be modified.

[DELETE] deletes the segment indicated by the pointer >.

[ADD] is used to add a new segment to be defined with the edit subsweep menu. If the list is empty, a default segment is added, and the edit subsweep menu is displayed so it can be modified. If the list is not empty, the segment indicated by the pointer > is copied and the edit subsweep menu is displayed.

[CLEAR LIST] clears the entire list.

[DONE] sorts the frequency points and returns to the sweep type menu.

Edit Subsweep Menu

This menu lets you select measurement frequencies arbitrarily. Using this menu it is possible to define the exact frequencies to be measured on a point-by-point basis. For example the sweep could include 100 points in a narrow passband, 100 points across a broad stop band, and 50 points across the third harmonic response. The total sweep is defined with a list of subsweeps. Up to 30 subsweeps can be defined, with a total of up to 1632 data points.

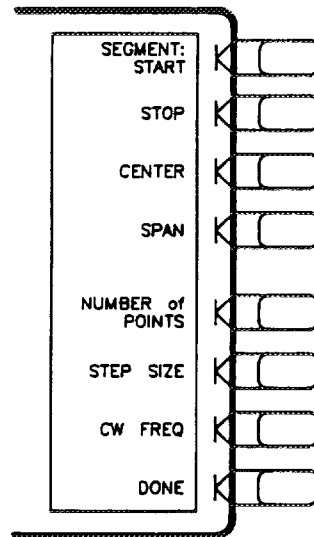

Figure 3-9. Edit Subsweep Menu

The frequency subsweeps, or segments, can be defined in any of the following terms:

- Start / stop / number of points
- Start / stop / step
- Center / span / number of points
- Center / span / step
- CW frequency

The subsweeps can overlap, and do not have to be entered in any particular order. The analyzer sorts the segments automatically and lists them on the CRT in order of increasing start frequency, even if they are entered in center/span format. If duplicate frequencies exist, the analyzer makes multiple measurements on identical points to maintain the specified number of points for each subsweep. The data is displayed on the CRT as a single trace that is a composite of all data taken. The trace may appear uneven because of the distribution of the data points, but the frequency scale is linear across the total range.

The list frequency sweep mode is selected with the **[LIST FREQ]** softkey in the sweep type menu.

The frequency list parameters can be saved with an instrument state.

[SEGMENT START] sets the start frequency of a subsweep.

[STOP] sets the stop frequency of a subsweep.

[CENTER] sets the center frequency of a subsweep.

[SPAN] sets the frequency span of a subsweep about a specified center frequency.

[NUMBER OF POINTS] sets the number of points for the subsweep. The total number of points for all the subsweeps cannot exceed 1632.

[STEP SIZE] is used to specify the subsweep in frequency steps instead of number of points. Changing the start frequency, stop frequency, span, or number of points may change the step size. Changing the step size may change the number of points and stop frequency in start/stop/step mode; or the frequency span in center/span/step mode. In each case, the frequency span becomes a multiple of the step size.

[CW] is used to set a subsweep consisting of a single CW frequency point.

[DONE] returns to the edit list menu.

Chapter 4. Response Function Block

CHAPTER CONTENTS

- 4-1 Introduction
- 4-3 **[MEAS]** Key
- 4-5 S-Parameter Menu
- 4-6 Input Ports Menu
- 4-7 Conversion Menu
- 4-8 **[FORMAT]** Key
- 4-8 Format Menu
- 4-13 Format More Menu
- 4-13 Group delay principles
- 4-16 **[SCALE REF]** Key
- 4-16 Scale Reference Menu
- 4-18 **[DISPLAY KEY]**
- 4-18 Display Menu
- 4-21 Display More Menu
- 4-23 Adjust Display Menu
- 4-24 Modify Colors Menu
- 4-25 Color Adjust Menu
- 4-25 Adjusting Color
- 4-27 Title Menu
- 4-28 Title More Menu
- 4-28 **[AVG]** Key
- 4-31 Average Menu

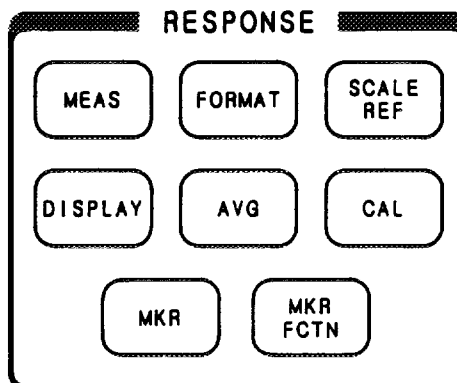

Figure 4-1. Response Function Block

INTRODUCTION

The keys in the RESPONSE block are used to control the measurement and display functions of the active channel. They provide access to many different softkey menus that offer selections for the parameters to be measured, the display mode and format of the data, the control of the display markers, and a variety of calibration functions.

The HP-IB programming command is shown in parenthesis following the key or softkey.

The current values for the major response functions of the active channel are displayed in specific locations along the top of the CRT. In addition, certain functions accessed through the keys in this block are annotated in the status notations area at the left side of the CRT. An illustration of the CRT showing the locations of these information labels is provided in Chapter 2, together with an explanation.

The RESPONSE block keys and their associated menus are described briefly below, and in more detail in this and the following chapters. General and specific measurement sequences are described in the *User's Guide*.

The **[MEAS]** (MENUMEAS) key provides access to a series of softkey menus for selecting the parameters or inputs to be measured.

The **[FORMAT]** (MENUFORM) key leads to a menu used to select the display format for the data. Various rectangular and polar formats are available for display of magnitude, phase, impedance, group delay, real data, and SWR.

The **[SCALE REF]** (MENUSCAL) key displays a menu used to modify the vertical axis scale and the reference line value, as well as to add electrical delay.

The **[DISPLAY]** (MENUDISP) key leads to a series of menus for instrument and active channel display functions. The first menu defines the displayed active channel trace in terms of the mathematical relationship between data and trace memory. Other functions include dual channel display (overlaid or split), display intensity, color selection, active channel display title, and frequency blanking.

The **[AVG]** (MENUAVG) key is used to access three different noise reduction techniques: sweep-to-sweep averaging, trace smoothing, and variable IF bandwidth.

The **[CAL]** (MENCAL) key leads to a series of menus to perform measurement calibrations for vector error correction (accuracy enhancement), and for specifying the calibration standards used. Calibration procedures are used to improve measurement accuracy by effectively removing systematic errors prior to making measurements. Several different levels of calibration are available for use in a variety of different measurement applications. Each calibration procedure features CRT prompts to guide you through the calibration sequence.

An explanation of vector error correction techniques to enhance measurement accuracy is included with the description of the calibration menus and procedures. Refer to Chapter 5, and to the Appendix to Chapter 5.

The **[CAL]** key also leads to softkeys which activate interpolated error correction and power meter calibration. These two features are fully explained in Chapter 5.

The **[MKR]** (MENUMARK) key displays an active marker (∇) on the screen and provides access to a series of menus to control from one to four display markers for each channel. Markers provide numerical readout of measured values at any point of the trace.

The menus accessed from the **[MKR]** key provide several basic marker operations. These include special marker modes for different display formats, and a marker delta mode that displays marker values relative to a specified value or another marker.

The **[MKR FCTN]** (MENUMRKF) key provides access to additional marker functions. These use the markers to search the trace for specified information, to analyze the trace statistically, or to quickly change the stimulus parameters.

[MEAS] KEY

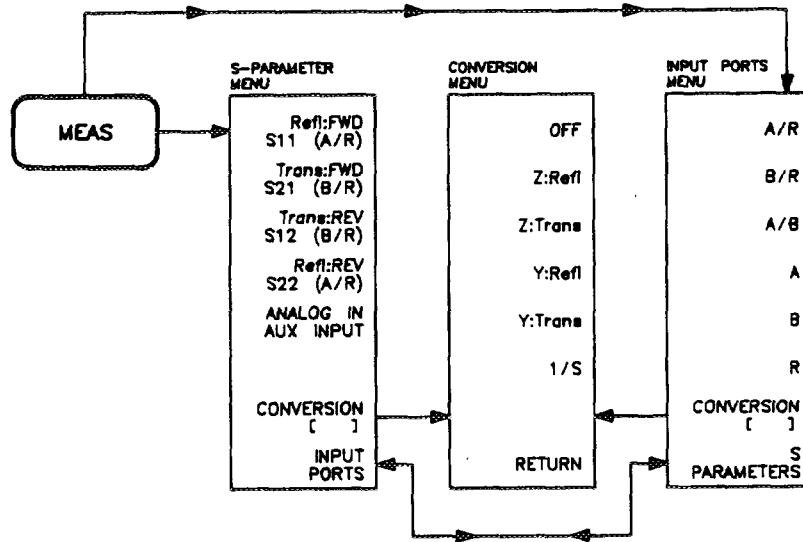

Figure 4-2. Softkey Menus Accessed from the [MEAS] Key

The HP-IB programming command is shown in parenthesis following the key or softkey.

The [MEAS] (MENUMEAS) key leads to a series of softkey menus used to determine the parameters or inputs to be measured. If an HP 85046A/B or 85047A S-parameter Test Set is connected, all four S-parameters can be measured with a single connection. Or S-parameters can be measured using a transmission/reflection test set by reversing the device under test between measurements. S-parameters are explained briefly below.

Alternatively, the power ratio of any two inputs or the absolute power at a single input can be measured and displayed, using either test set.

S-parameters can be converted to impedance (Z), admittance (Y), or inverse S-parameters through internal math capabilities of the analyzer.

S-Parameters

S-parameters (scattering parameters) are a convention used to characterize the way a device modifies signal flow. A brief explanation is provided here of the S-parameters of a two-port device. For additional details refer to Hewlett-Packard Application Notes A/N 95-1 and A/N 154.

S-parameters are always a ratio of two complex (magnitude and phase) quantities. S-parameter notation identifies these quantities using the numbering convention:

$$S_{out\ in}$$

where the first number (out) refers to the port where the signal is emerging and the second number (in) is the port where the signal is incident. For example, the S-parameter S21 identifies the measurement as the complex ratio of the signal emerging at port 2 to the signal incident at port 1.

Figure 4-3 is a representation of the S-parameters of a two-port device, together with an equivalent flowgraph. In the illustration, "a" represents the signal entering the device and "b" represents the signal emerging. Note that a and b are not related to the A and B input ports on the analyzer.

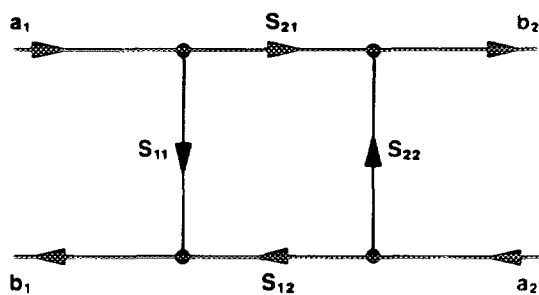
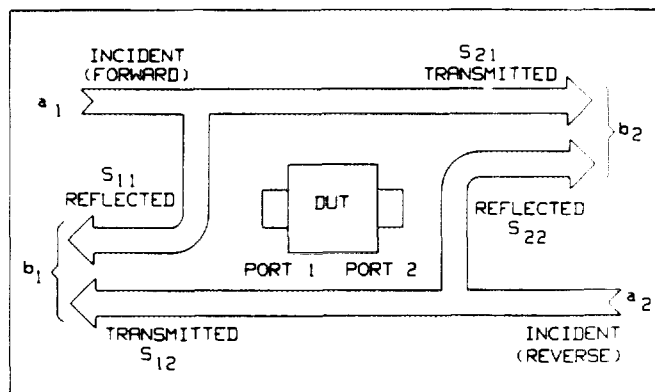

Figure 4-3. S-Parameters of a Two-Port Device

S-parameters are exactly equivalent to the more common description terms below, requiring only that the measurements be taken with all DUT ports properly terminated.

S-Parameter	Definition	Test Set Description	Direction
S_{11}	$\frac{b_1}{a_1} \mid a_2=0$	Input reflection coefficient	FWD
S_{21}	$\frac{b_2}{a_1} \mid a_2=0$	Forward gain	FWD
S_{12}	$\frac{b_1}{a_2} \mid a_1=0$	Reverse gain	REV
S_{22}	$\frac{b_2}{a_2} \mid a_1=0$	Output reflection coefficient	REV

S-Parameter Menu

The S-parameter menu is presented automatically when the [MEAS] key is pressed, if an HP 85046A/B or 85047A S-parameter test set is connected to the analyzer or if two-port error correction is on. This menu is used to define the input ports and test set direction for S-parameter measurements. The analyzer controls the S-parameter test set, and automatically switches the direction of the measurement according to the selections made in this menu. All four S-parameters can be measured with a single connection. The S-parameter being measured is labeled at the top left corner of the CRT.

S-parameter measurements can also be made using an HP 85044A/B transmission/reflection test set, by reversing the device under test after making the forward reflection and transmission measurements. In this case, the softkey labels are changed to indicate the actual input ratios being measured (A/R for reflection or B/R for transmission measurements). Thus [Ref: REV S22 (B/R)] becomes [Ref: REV S22 (A/R)], and [Trans: REV S12 (A/R)] becomes [Trans: REV S12 (B/R)]. However, the annotation in the top left corner indicates the S-parameter being measured.

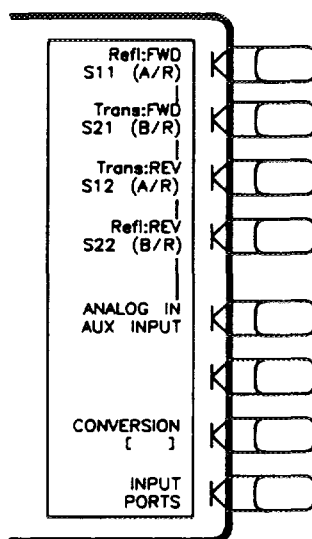

Figure 4-4. S-Parameter Menu

[Ref: FWD S11 (A/R)] (S11) configures the S-parameter test set for a measurement of S11, the complex reflection coefficient (magnitude and phase) of the test device input.

[Trans: FWD S21 (B/R)] (S21) configures the S-parameter test set for a measurement of S21, the complex forward transmission coefficient (magnitude and phase) of the device under test.

[Trans: REV S12 (A/R)] (S12) configures the S-parameter test set for a measurement of S12, the complex reverse transmission coefficient (magnitude and phase) of the device under test.

If an HP 85044A/B transmission/reflection test set is being used to make S-parameter measurements, reverse the device under test before making this measurement.

[Ref: REV S22 (B/R)] (S22) defines the measurement as S22, the complex reflection coefficient (magnitude and phase) of the output of the device under test.

If an HP 85044A/B transmission/reflection test set is being used to make S-parameter measurements, the device under test must be reversed before S12 and S22 are measured.

[ANALOG IN] (ANAI) displays a DC or low frequency AC auxiliary voltage on the vertical axis, using the real format. An external signal source such as a detector or function generator can be connected to the rear panel AUXILIARY INPUT connector. (For service purposes, one of numerous internal voltage nodes on the analog bus can be selected for measurement and display. Applications of this function are described in the *On-Site System Service Manual*.)

[CONVERSION] brings up the conversion menu which converts the measured data to impedance (Z) or admittance (Y). When a conversion parameter has been defined, it is shown in brackets under the softkey label. If no conversion has been defined, the softkey label reads **[CONVERSION OFF]**.

[INPUT PORTS] goes to the input ports menu, which is used to define a ratio or single-input measurement rather than an S-parameter measurement.

Input Ports Menu

The input ports menu is presented when the **[MEAS]** key is pressed if there is no S-parameter test set connected and two-port error correction is not on. This menu is used to define the input ports for power ratio measurements, or a single input for magnitude only measurements of absolute power. Single inputs cannot be used for phase or group delay measurements, or any measurements with averaging turned on.

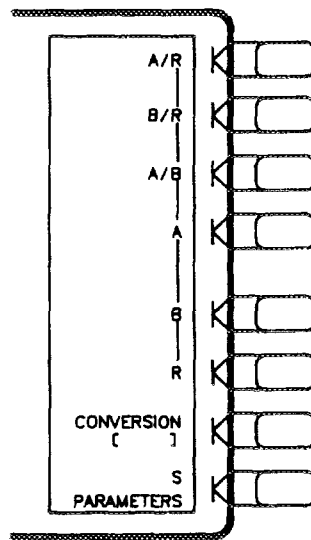

Figure 4-5. Input Ports Menu

[A/R] (AR) calculates and displays the complex ratio of the signal at input A to the reference signal at input R.

[B/R] (BR) calculates and displays the complex ratio of input B to input R.

[A/B] (AB) calculates and displays the complex ratio of input A to input B.

[A] (MEASA) measures the absolute power amplitude at input A.

[B] (MEASB) measures the absolute power amplitude at input B.

[R] (MEASR) measures the absolute power amplitude at input R. The R input is part of the source phase locking scheme, and therefore has a limited dynamic range.

[CONVERSION] presents the conversion menu, which converts the measured data to impedance (Z) or admittance (Y). When a conversion parameter has been defined, it is shown in brackets under the softkey label. If no conversion has been defined, the softkey label reads **[CONVERSION OFF]**.

[S PARAMETERS] presents the S-parameter menu, which is used to define the input ports and test set direction for S-parameter measurements.

Conversion Menu

This menu converts the measured reflection or transmission data to the equivalent complex impedance (Z) or admittance (Y) values. This is not the same as a two-port Y or Z parameter conversion, as only the measured parameter is used in the equations. Two simple one-port conversions are available, depending on the measurement configuration.

An S11 or S22 trace measured as reflection can be converted to equivalent parallel impedance or admittance using the model and equations shown in Figure 4-6.

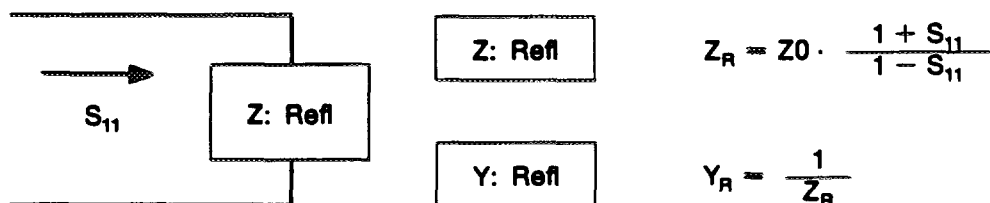

Figure 4-6. Reflection Impedance and Admittance Conversions

In a transmission measurement, the data can be converted to its equivalent series impedance or admittance using the model and equations shown in Figure 4-7.

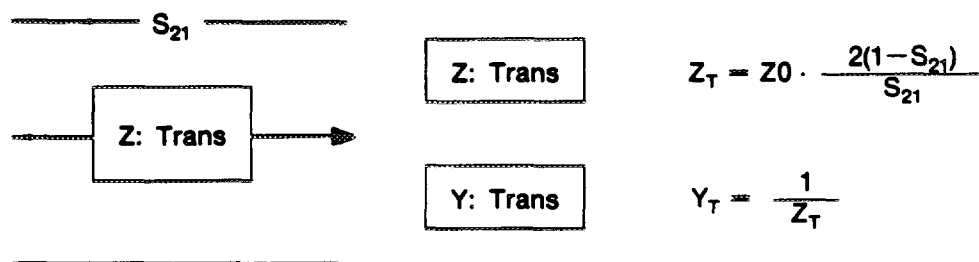

Figure 4-7. Transmission Impedance and Admittance Conversions

Avoid the use of Smith chart, SWR, and delay formats for display of Z and Y conversions, as these formats are not easily interpreted.

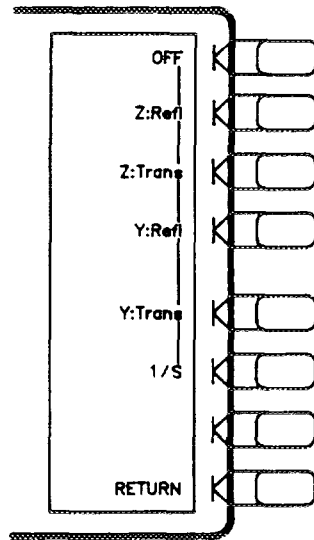

Figure 4-8. Conversion Menu

[OFF] (CONVOFF) turns off all parameter conversion operations.

[Z: Ref] (CONVZREF) converts reflection data to its equivalent impedance values.

[Z: Trans] (CONVZTRA) converts transmission data to its equivalent impedance values.

[Y: Ref] (CONVYREF) converts reflection data to its equivalent admittance values.

[Y: Trans] (CONVYTRA) converts transmission data to its equivalent admittance values.

[1/S] (CONV1DS) expresses the data in inverse S-parameter values, for use in amplifier and oscillator design. A convenient way to check for transistor stability is to compare S11 and 1/S22 on a Smith chart using a dual channel overlaid display (see *Display Menu*).

[RETURN] returns to the last menu, either the S-parameter or the input ports menu.

[FORMAT] KEY

The HP-IB programming command is shown in parenthesis following the key or softkey.

Format Menu

The **[FORMAT]** (MENUFORM) key presents a menu used to select the appropriate display format for the measured data. Various rectangular and polar formats are available for display of magnitude, phase, real data, imaginary data, impedance, group delay, and SWR. The units of measurement are changed automatically to correspond with the displayed format. Special marker menus are available for the polar and Smith formats, each providing several different marker types for readout of values (see Chapter 6).

The format defined for display of a particular S-parameter or input is remembered with that parameter. Thus if different parameters are measured, even if only one channel is used, each parameter is shown in its selected format each time it is displayed.

The illustrations below show a reflection measurement of a bandpass filter displayed in each of the available formats.

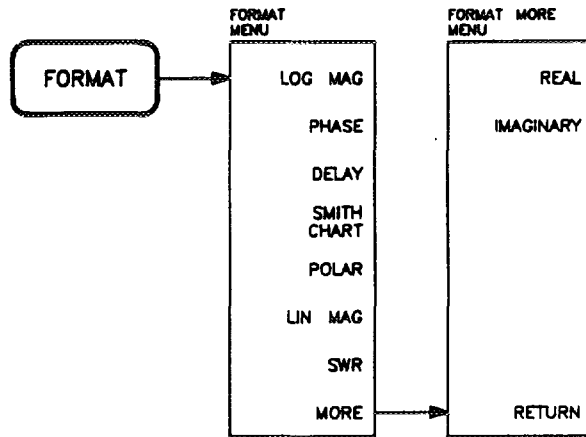

Figure 4-9. Format and Format More Menus

[LOG MAG] (LOGM) displays the log magnitude format. This is the standard Cartesian format used to display magnitude-only measurements of insertion loss, return loss, or absolute power in dB versus frequency. Figure 4-10 illustrates the bandpass filter reflection data in a log magnitude format.

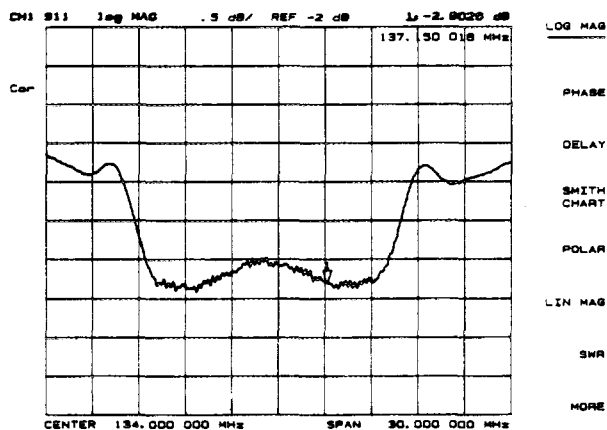

Figure 4-10. Log Magnitude Format

[PHASE] (PHAS) displays a Cartesian format of the phase portion of the data, measured in degrees. This format displays the phase shift versus frequency. Figure 4-11 illustrates the phase response of the same filter in a phase-only format. A measurement of phase response is described in the *User's Guide*.

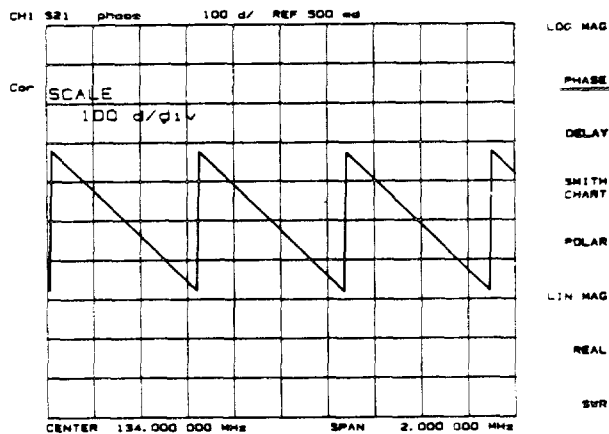

Figure 4-11. Phase Format

[DELAY] (DELA) selects the group delay format, with marker values given in seconds. Figure 4-12 shows the bandpass filter response formatted as group delay. Group delay principles are described in the next few pages.

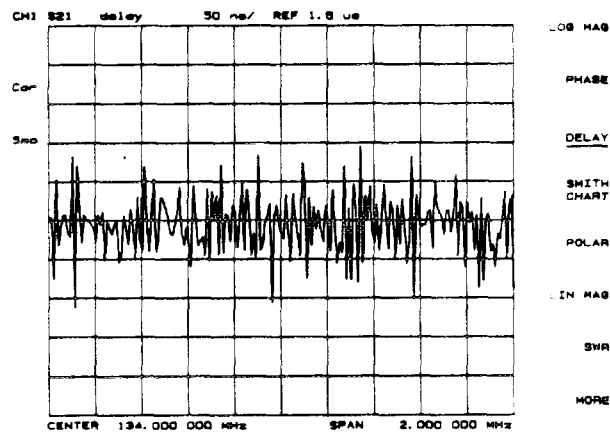

Figure 4-12. Group Delay Format

[SMITH CHART] (SMIC) displays a Smith chart format (Figure 4-13). This is used in reflection measurements to provide a readout of the data in terms of impedance. The intersecting dotted lines on the Smith chart represent constant resistance and constant reactance values, normalized to the characteristic impedance, Z_0 , of the system. Reactance values in the upper half of the Smith chart circle are positive (inductive) reactance, and in the lower half of the circle are negative (capacitive) reactance. The default marker readout is in units of resistance and reactance ($R + jX$). Additional marker types are available in the Smith marker menu (refer to Chapter 6).

The Smith chart is most easily understood with a full scale value of 1.0. If the scale per division is less than 0.2, the format switches automatically to polar.

If the characteristic impedance of the system is not 50 ohms, modify the impedance value recognized by the analyzer using the **[SET Z0]** softkey in the calibrate more menu. Refer to Chapter 5.

An inverted Smith chart format for admittance measurements (Figure 4-13) is also available. Access this by selecting **[SMITH CHART]** in the format menu, and pressing **[MKR] [MARKER MODE MENU] [SMITH MKR MENU] [G+jB MKR]**. The Smith chart is reversed and marker values are read out in units of conductance and susceptance ($G + jB$).

Procedures for measuring impedance and admittance are provided in the *User's Guide*.

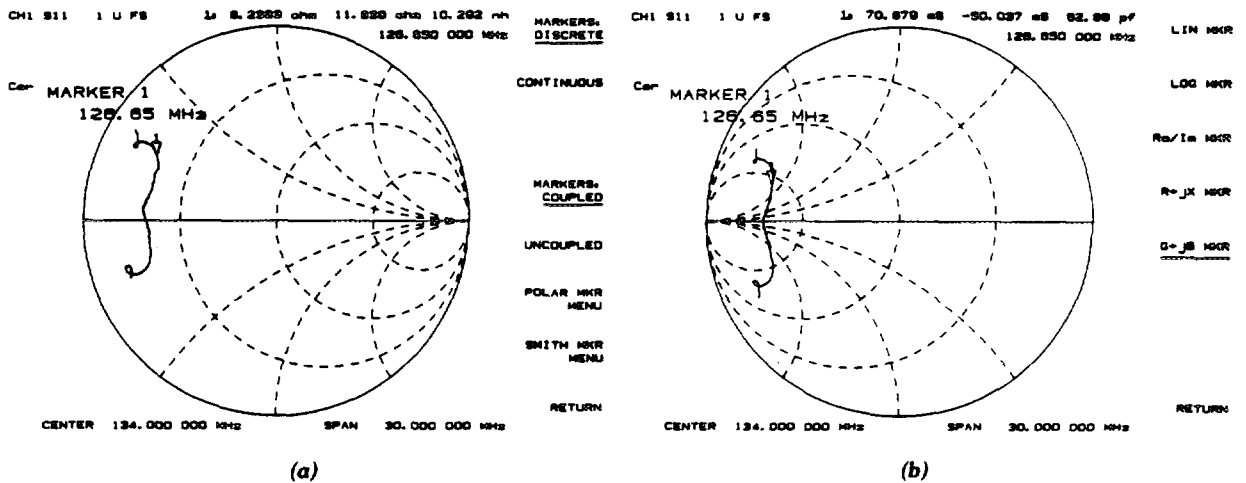

Figure 4-13. Standard and Inverse Smith Chart Formats

[POLAR] (POLA) displays a polar format (Figure 4-14). Each point on the polar format corresponds to a particular value of both magnitude and phase. Quantities are read vectorally: the magnitude at any point is determined by its displacement from the center (which has zero value), and the phase by the angle counterclockwise from the positive x-axis. Magnitude is scaled in a linear fashion, with the value of the outer circle usually set to a ratio value of 1. Since there is no frequency axis, frequency information is read from the markers.

The default marker readout for the polar format is in linear magnitude and phase. A log magnitude marker and a real/imaginary marker are available in the polar marker menu (refer to Chapter 6).

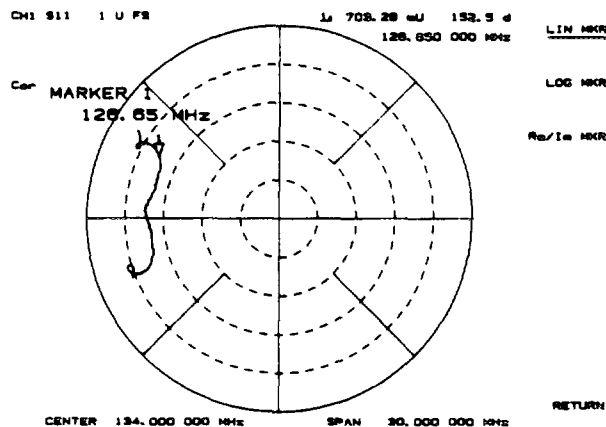

Figure 4-14. Polar Format

[LIN MAG] (LINM) displays the linear magnitude format (Figure 4-15). This is a Cartesian format used for unitless measurements such as reflection coefficient magnitude ρ or transmission coefficient magnitude τ , and for linear measurement units. It is used for display of conversion parameters and time domain transform data.

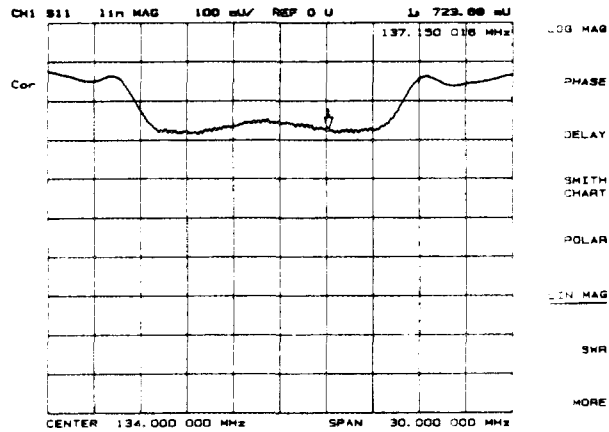

Figure 4-15. Linear Magnitude Format

[SWR] (SWR) reformats a reflection measurement into its equivalent SWR (standing wave ratio) value (Figure 4-16). SWR is equivalent to $(1 + \rho)/(1 - \rho)$, where ρ is the reflection coefficient. Note that the results are valid only for reflection measurements. If the SWR format is used for measurements of S21 or S12 the results are not valid.

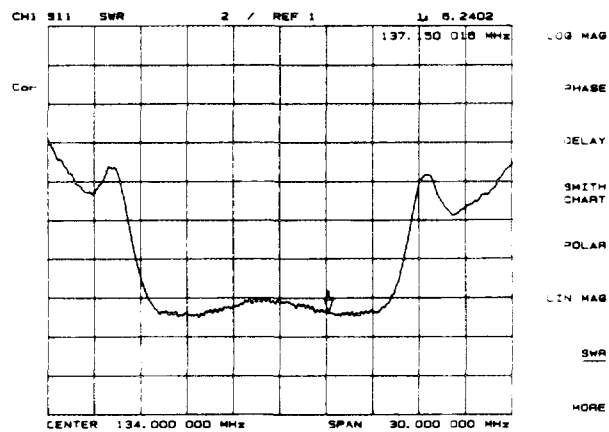

Figure 4-16. Typical SWR Display

[MORE] goes to the format more menu described on the next page.

Format More Menu

This menu provides two additional formatting selections.

[REAL] (REAL) displays only the real (resistive) portion of the measured data on a Cartesian format (Figure 4-16). This is similar to the linear magnitude format, but can show both positive and negative values. It is primarily used for analyzing responses in the time domain, and also to display an auxiliary input voltage signal for service purposes.

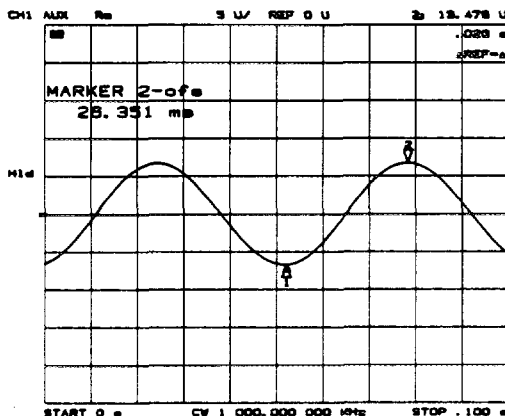

Figure 4-17. Real Format

[IMAGINARY] (IMAG) displays only the imaginary (reactive) portion of the measured data on a Cartesian format. This format is similar to the real format except that reactance data is displayed on the trace instead of impedance data.

[RETURN] goes back to the format menu.

GROUP DELAY PRINCIPLES

For many networks, the amount of insertion phase is not as important as the linearity of the phase shift over a range of frequencies. The analyzer can measure this linearity and express it in two different ways: directly, as deviation from linear phase, or as group delay, a derived value. Refer to **[SCALE REF]** key description in this chapter for information on deviation from linear phase.

Group delay is the measurement of signal transmission time through a test device. It is defined as the derivative of the phase characteristic with respect to frequency. Since the derivative is basically the instantaneous slope (or rate of change of phase with frequency), a perfectly linear phase shift results in a constant slope, and therefore a constant group delay (Figure 4-18).

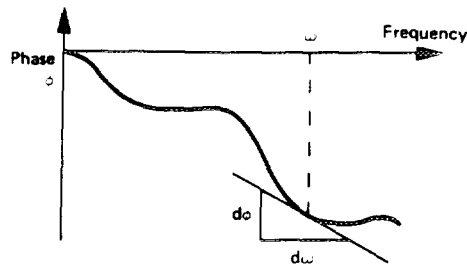
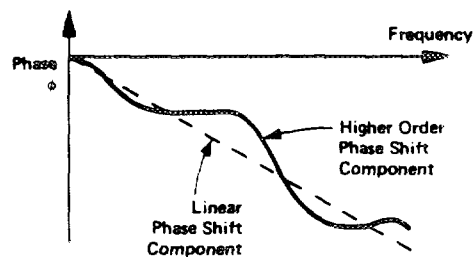

Figure 4-18. Constant Group Delay

Note, however, that the phase characteristic typically consists of both linear and higher order (deviations from linear) components. The linear component can be attributed to the electrical length of the test device, and represents the average signal transit time. The higher order components are interpreted as variations in transit time for different frequencies, and represent a source of signal distortion (Figure 4-19).



$$\text{Group Delay} \approx \tau_g = \frac{-d\phi}{d\omega} \quad \begin{array}{l} \phi \text{ in Radians} \\ \omega \text{ in Radians} \end{array}$$

$$= \frac{-1}{360^\circ} \cdot \frac{d\phi}{df} \quad \begin{array}{l} \phi \text{ in Degrees} \\ f \text{ in Hz } (\omega = 2\pi f) \end{array}$$

Figure 4-19. Higher Order Phase Shift

The analyzer computes group delay from the phase slope. Phase data is used to find the phase change, $\Delta\phi$, over a specified frequency aperture, Δf , to obtain an approximation for the rate of change of phase with frequency (Figure 4-20). This value, τ_g , represents the group delay in seconds assuming linear phase change over Δf . It is important that $\Delta\phi$ be $\leq 180^\circ$, or errors will result in the group delay data. These errors can be significant for long delay devices. You can verify that $\Delta\phi$ is $\leq 180^\circ$ by increasing the number of points or narrowing the frequency span (or both) until the group delay data no longer changes.

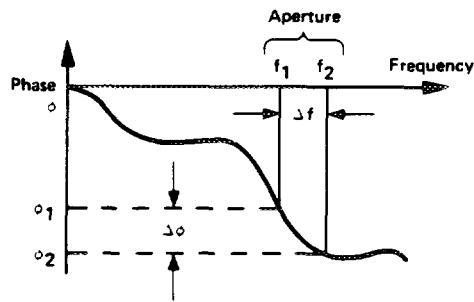

Figure 4-20. Rate of Phase Change Versus Frequency

When deviations from linear phase are present, changing the frequency step can result in different values for group delay. Note that in this case the computed slope varies as the aperture Δf is increased (Figure 4-21). A wider aperture results in loss of the fine grain variations in group delay. This loss of detail is the reason that in any comparison of group delay data it is important to know the aperture used to make the measurement.

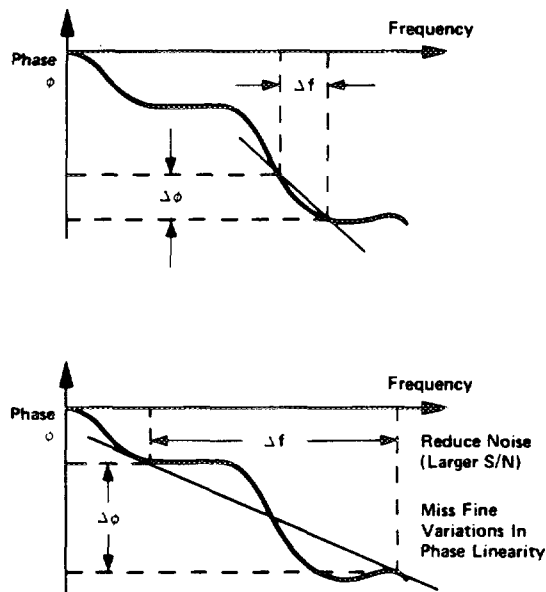

Figure 4-21. Variations in Frequency Aperture

In determining the group delay aperture, there is a tradeoff between resolution of fine detail and the effects of noise. Noise can be reduced by increasing the aperture, but this will tend to smooth out the fine detail. More detail will become visible as the aperture is decreased, but the noise will also increase, possibly to the point of obscuring the detail. A good practice is to use a smaller aperture to assure that small variations are not missed, then increase the aperture to smooth the trace.

The default group delay aperture is the frequency span divided by the number of points across the display. To set the aperture to a different value, turn on smoothing in the average menu, and vary the smoothing aperture (see [AVG] Key). The aperture can be varied up to 20% of the span swept.

Group delay measurements can be made on linear frequency, log frequency, or list frequency sweep types (not in CW or power sweep). Group delay aperture varies depending on the frequency spacing and point density, therefore the aperture is not constant in log and list frequency sweep modes. In list frequency mode, extra frequency points can be defined to ensure the desired aperture.

To obtain a readout of aperture values at different points on the trace, turn on a marker. Then press **[AVG] [SMOOTHING APERTURE]**. Smoothing aperture becomes the active function, and as the aperture is varied its value in Hz is displayed below the active entry area.

A group delay measurement procedure is provided in the *User's Guide*.

[SCALE REF] KEY

The HP-IB programming command is shown in parenthesis following the key or softkey.

Scale Reference Menu

The **[SCALE REF] (MENUSCAL)** key makes scale per division the active function. A menu is displayed that is used to modify the vertical axis scale and the reference line value and position. In addition this menu provides electrical delay offset capabilities for adding or subtracting linear phase to maintain phase linearity.

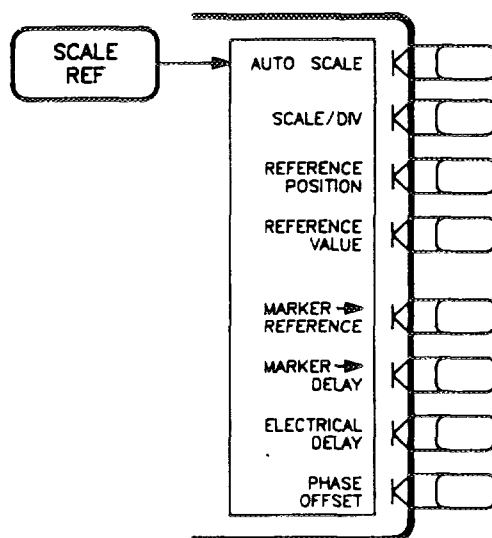

Figure 4-22. Scale Reference Menu

[AUTO SCALE] (AUTO) brings the trace data in view on the CRT with one keystroke. Stimulus values are not affected, only scale and reference values. The analyzer determines the smallest possible scale factor that will put all displayed data onto 80% of the vertical graticule. The reference value is chosen to put the trace in center screen, then rounded to an integer multiple of the scale factor.

[SCALE/DIV] (SCAL) changes the response value scale per division of the displayed trace. In polar and Smith chart formats, this refers to the full scale value at the outer circumference, and is identical to reference value.

[REFERENCE POSITION] (REFF) sets the position of the reference line on the graticule of a Cartesian display, with 0 the bottom line of the graticule and 10 the top line. It has no effect on a polar or Smith display. The reference position is indicated with a small triangle just outside the graticule, on the left side for channel 1 and the right side for channel 2.

[REFERENCE VALUE] (REFV) changes the value of the reference line, moving the measurement trace correspondingly. In polar and Smith chart formats, the reference value is the same as the scale, and is the value of the outer circle.

[MARKER → REFERENCE] (MARKREF) makes the reference value equal to the active marker's absolute value (regardless of the delta marker value). The marker is effectively moved to the reference line position. This softkey also appears in the marker function menu accessed from the **[MKR FCTN]** key. In polar and Smith chart formats this function makes the full scale value at the outer circle equal to the active marker response value.

[MARKER → DELAY] (MARKDELA) adjusts the electrical delay to balance the phase of the DUT. This is performed automatically, regardless of the format and the measurement being made. Enough line length is added to or subtracted from the receiver input to compensate for the phase slope at the active marker position. This effectively flattens the phase trace around the active marker, and can be used to measure electrical length or deviation from linear phase. Additional electrical delay adjustments are required on DUTs without constant group delay over the measured frequency span. Since this feature adds phase to a variation in phase versus frequency, it is applicable only for ratioed inputs.

[ELECTRICAL DELAY] (ELED) adjusts the electrical delay to balance the phase of the DUT. It simulates a variable length lossless transmission line, which can be added to or removed from a receiver input to compensate for interconnecting cables, etc. This function is similar to the mechanical or analog "line stretchers" of other network analyzers. Delay is annotated in units of time with secondary labeling in distance for the current velocity factor.

With this feature, and with **[MARKER → DELAY]**, an equivalent length of air is added or subtracted according to the following formula:

$$\text{Length (metres)} = \frac{\phi}{F(\text{MHz}) \times 1.20083}$$

Once the linear portion of the DUT's phase has been removed, the equivalent length of air can be read out in the active marker area. If the average relative permittivity (ϵ_r) of the DUT is known over the frequency span, the length calculation can be adjusted to indicate the actual length of the DUT more closely. This can be done by entering the relative velocity factor for the DUT using the calibrate more menu. The relative velocity factor for a given dielectric can be calculated by:

$$\text{Velocity factor} = 1/\sqrt{\epsilon_r}$$

assuming a relative permeability of 1.

A procedure for measuring electrical length or deviation from linear phase using the **[ELECTRICAL DELAY]** or **[MARKER → DELAY]** features is provided in the *User's Guide*.

[PHASE OFFSET] (PHAO) adds or subtracts a phase offset that is constant with frequency (rather than linear). This is independent of **[MARKER → DELAY]** and **[ELECTRICAL DELAY]**.

[DISPLAY] KEY

The HP-IB programming command is shown in parenthesis following the key or softkey.

The [DISPLAY] (MENUMDISP) key provides access to the memory math functions, and other display functions including dual channel display, active channel display title, frequency blanking, display intensity, background intensity, and color selection.

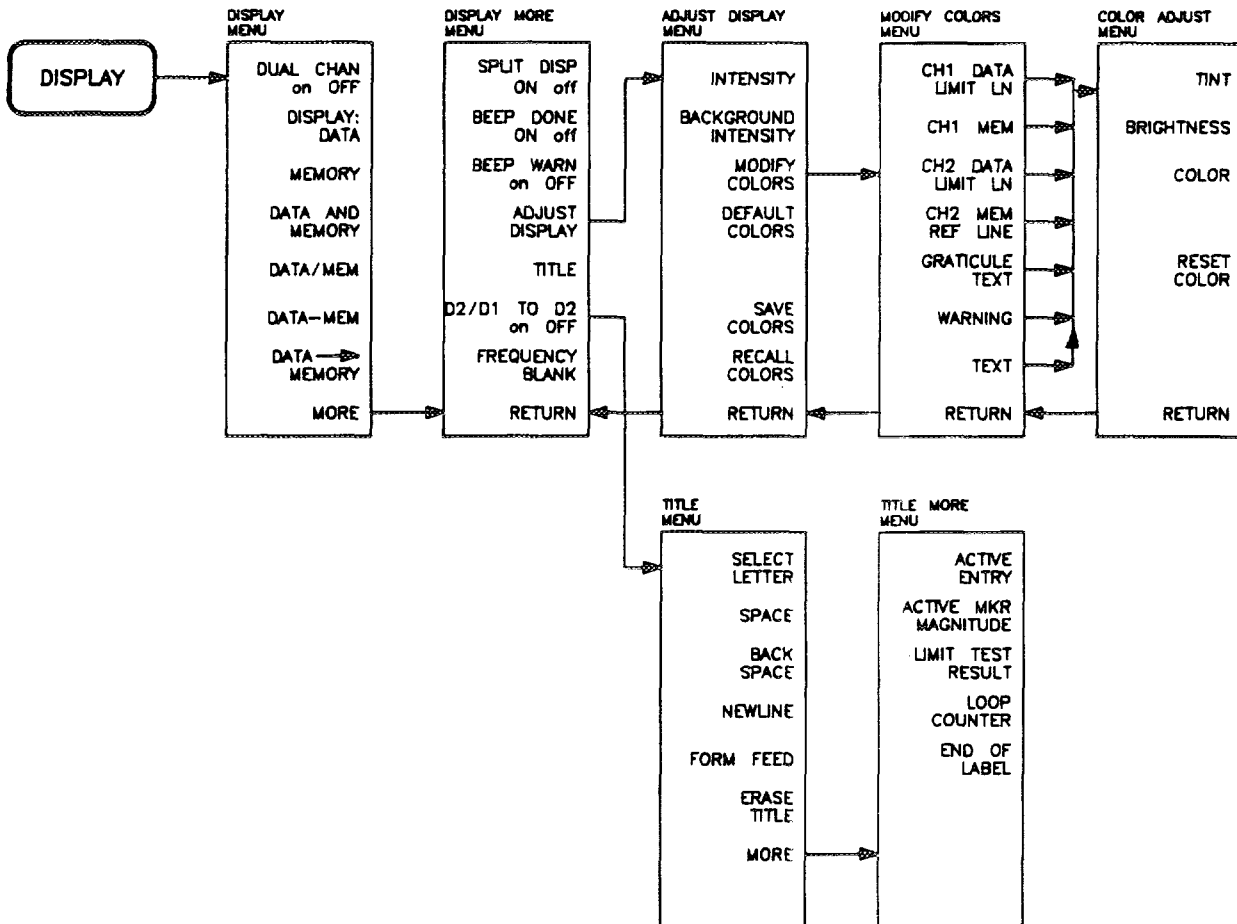

Figure 4-23. Softkey Menus Accessed from the [DISPLAY] Key

Display Menu

This menu provides trace math capabilities for manipulating data, as well as the capability of displaying both channels simultaneously, either overlaid or split.

The analyzer has two available memory traces, one per channel. Memory traces are totally channel dependent: channel 1 cannot access the channel 2 memory trace or vice versa. Memory traces can be saved with instrument states: one memory trace can be saved per channel per saved instrument state. Five save/recall registers are available for each channel, so the total number of memory traces that can be present is 12 including the two active for the current instrument state. The memory data is stored as full precision, complex data. (Refer to Chapter 10.)

Two trace math operations are implemented, data/memory and data-memory. (Note that normalization is data/memory not data-memory.) Memory traces are saved and recalled and trace math is done immediately after error correction. This means that any data processing done after error correction, including parameter conversion, time domain transformation (option 010), scaling, etc., can be performed on the memory trace. (Refer to *Data Processing* in Chapter 1.) Trace math can also be used as a simple means of error correction, although that is not its main purpose.

All data processing operations that occur after trace math, except smoothing and gating, are identical for the data trace and the memory trace. If smoothing or gating is on when a memory trace is saved, this state is maintained regardless of the data trace smoothing or gating status. If a memory trace is saved with gating or smoothing on, these features can be turned on or off in the memory-only display mode.

The actual memory for storing a memory trace is allocated only as needed. The memory trace is cleared on instrument preset, power on, or instrument state recall.

If sweep mode or sweep range is different between the data and memory traces, trace math is allowed, and no warning message is displayed. If the number of points in the two traces is different, the memory trace is not displayed nor rescaled. However, if the number of points for the data trace is changed back to the number of points in the memory, the memory trace can then be displayed.

If trace math or display memory is requested and no memory trace exists, the message "CAUTION: NO VALID MEMORY TRACE" is displayed.

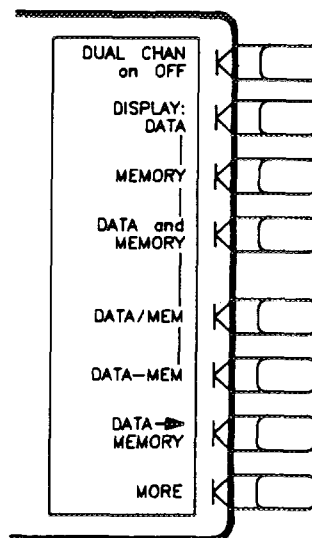

Figure 4-24. Display Menu

[DUAL CHAN on OFF] (DUACON, DUACOFF) toggles between display of both measurement channels or the active channel only. This is used in conjunction with **[SPLIT DISP ON off]** in the display more menu to display both channels. With **[SPLIT DISP OFF]** the two traces are overlaid on a single graticule (Figure 4-25a); with **[SPLIT DISP ON]** the measurement data is displayed on two half-screen graticules one above the other (Figure 4-25b). Current parameters for the two displays are annotated separately.

The stimulus functions of the two channels can also be controlled independently using **[COUPLED CH ON]** in the stimulus menu. In addition, the markers can be controlled independently for each channel using **[MARKERS: UNCOUPLED]** in the marker mode menu.

Problems with Dual Channel Mode. If you have decoupled channels 1 and 2, and are using dual channel, there are two measurement configurations which may not appear to function "properly".

The two configurations, shown below, would cause repeated switching of either the test port transfer switch or the step attenuator. To avoid premature wearing out of these mechanical devices, the test set will not allow these measurements to occur without direct intervention by the operator:

- Channel 1 is driving one test port and channel 2 is driving the other. For example, you are making an S_{21} measurement on channel 1 and an S_{12} measurement on channel 2. This configuration, if allowed unchecked, would cause the test port transfer switch to continually cycle.
- Channel 1 requires one attenuation value, and channel 2 requires a different value. Since one attenuator is used for both test ports, this would cause the attenuator to continuously switch settings.

If either of the above conditions exist, the test set hold mode will engage, and the status notation "tsH" will appear on the left side of the screen. The hold mode may be overridden by either the **[MEASURE RESTART]** or **[NUMBER OF GROUPS]** softkeys, described in Chapter 3, *Stimulus Function Block*. For more information, refer to *Test Set Attenuator, Test Port Transfer Switch, and Doubler Switch Protection*, in the beginning of Chapter 3.

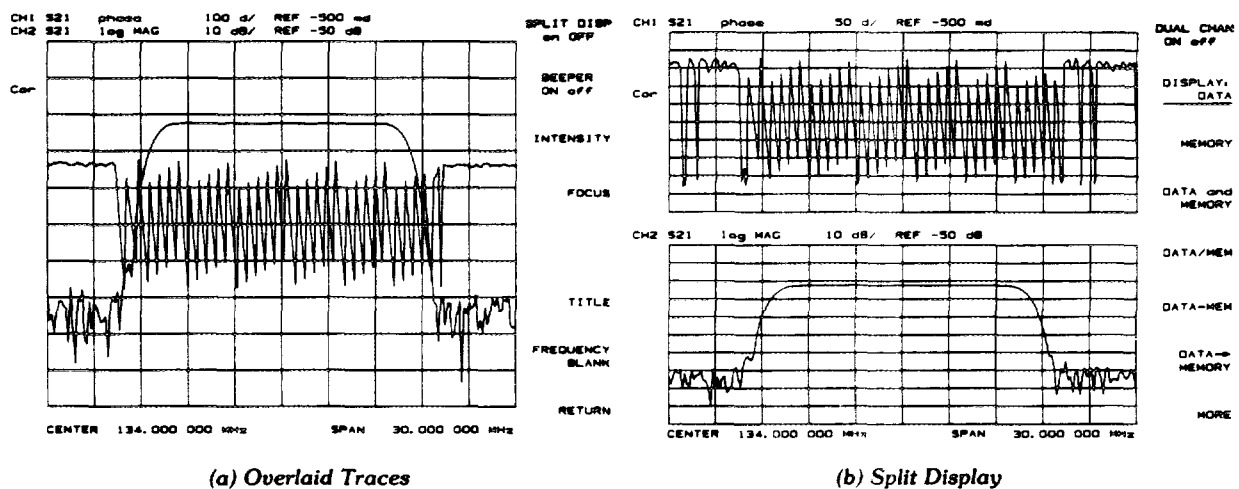

Figure 4-25. Dual Channel Displays

[DISPLAY: DATA] (DISPDATA) displays the current measurement data for the active channel.

[MEMORY] (DISPMEMO) displays the trace memory for the active channel. This is the only memory display mode where the smoothing and gating of the memory trace can be changed. If no data has been stored in memory for this channel, a warning message is displayed.

[DATA and MEMORY] (DISPDATM) displays both the current data and memory traces.

[DATA/MEM] (DISPDDM) divides the data by the memory, normalizing the data to the memory, and displays the result. This is useful for ratio comparison of two traces, for instance in measurements of gain or attenuation.

[DATA — MEM] (DISPDMM) subtracts the memory from the data. The vector subtraction is performed on the complex data. This is appropriate for storing a measured vector error, for example directivity, and later subtracting it from the device measurement.

[DATA → MEMORY] (DATI) stores the current active measurement data in the memory of the active channel. It then becomes the memory trace, for use in subsequent math manipulations or display. If a parameter has just been changed and the * status notation is displayed at the left of the CRT, the data is not stored in memory until a clean sweep has been executed. The gating and smoothing status of the trace are stored with the measurement data.

[MORE] leads to the display more menu.

Display More Menu

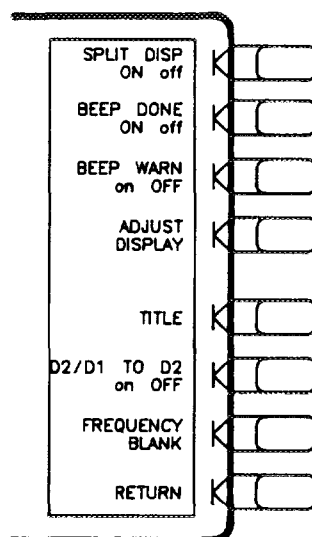

Figure 4-26. Display More Menu

[SPLIT DISP on OFF] (SPLDON, SPLDOFF) toggles between a full-screen single graticule display of one or both channels, and a split display with two half-screen graticules one above the other. Both displays are illustrated in Figure 4-25. The split display can be used in conjunction with **[DUAL CHAN ON]** in the display menu to show the measured data of each channel simultaneously on separate graticules. In addition, the stimulus functions of the two channels can be controlled independently using **[COUPLED CH ON]** in the stimulus menu. The markers can also be controlled independently for each channel using **[MARKERS: UNCOUPLED]** in the marker mode menu.

[BEEP DONE ON off] (BEEPDONEON, BEEPDONEOFF) toggles an annunciator which sounds to indicate completion of certain operations such as calibration or instrument state save.

[BEEP WARN on OFF] (BEEPWARNON, BEEPWARNOFF) toggles the warning annunciator. When the annunciator is on it sounds a warning when a cautionary message is displayed.

[ADJUST DISPLAY] presents a menu for adjusting display intensity, colors, and accessing save and recall functions for modified CRT display color sets.

[TITLE] (TITL) presents the title menu in the softkey labels area and the character set in the active entry area. These are used to label the active channel display. A title more menu allows up to four values to be included in the printed title; active entry, active marker amplitude, limit test results, and loop counter value.

[FREQUENCY BLANK] (FREO) blanks the displayed frequency notation for security purposes. Frequency labels cannot be restored except by instrument preset or turning the power off and then on.

[D2/D1 to D2] (D1DIVD2) this math function ratios channels 1 and 2, and puts the results in the channel 2 data array. Both channels must be on and have the same number of points. This feature is particularly useful for making harmonic measurements in an analyzer equipped with option 002. With the fundamental frequency displayed on channel 1 and the measured harmonic on channel 2, this key displays the relative amplitude of the harmonic with respect to the fundamental.

[RETURN] goes back to the display menu.

Adjust Display Menu

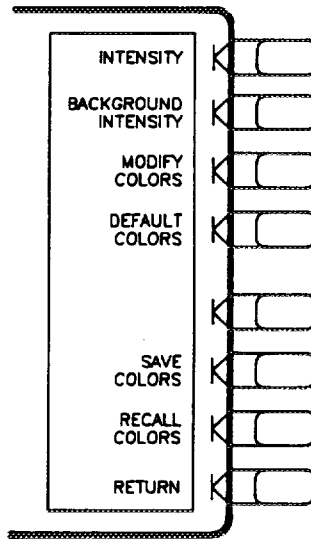

Figure 4-27. Adjust Display Menu

[INTENSITY] (INTE) sets the CRT intensity as a percent of the brightest setting. The factory-set default value is stored in non-volatile memory.

[BACKGROUND INTENSITY] (BACI) sets the background intensity of the CRT as a percent of white. The factory-set default value is stored in non-volatile memory.

[MODIFY COLORS] present a menu for color modification of CRT display elements. Refer to *Adjusting Color* for information on modifying CRT display elements.

[DEFAULT COLORS] (DEFC) returns all the color settings back to the factory-set default values that are stored in non-volatile memory.

[SAVE COLORS] (SVCO) saves the modified version of the color set.

[RECALL COLORS] (RECC) recalls the previously saved modified version of the color set. This key appears only when a color set has been saved.

[RETURN] goes back to the display more menu.

Modify Colors Menu

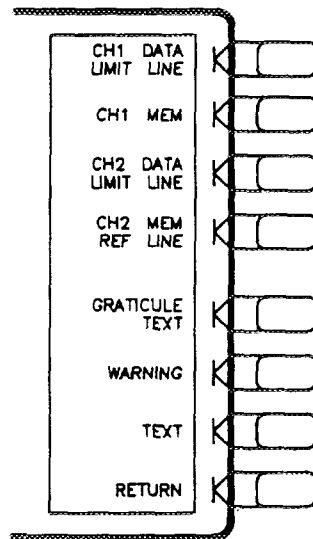

Figure 4-28. Modify Colors Menu

[CH1 DATA|LIMIT LN] (COLOCH1D) selects channel 1 data trace and limit line for color modification.

[CH1 MEM] (COLOCH1M) selects channel 1 memory trace for color modification.

[CH2 DATA|LIMIT LN] (COLOCH2D) selects channel 2 data trace and limit line for color modification.

[CH2 MEM|REF LINE] (COLOCH2M) selects channel 2 memory and the reference line for color modification.

[GRATICULE|TEXT] (COLOGRAT) selects the graticule and a portion of softkey text (where there is a choice of a feature being on or off) for color modification. For example: [FREQUENCY BLANK on OFF].

[WARNING] (COLOWARN) selects the warning annotation for color modification.

[TEXT] (COLOTEXT) selects all the non-data text for color modification. For example: operating parameters.

[RETURN] goes back to the adjust display menu.

Color Adjust Menu

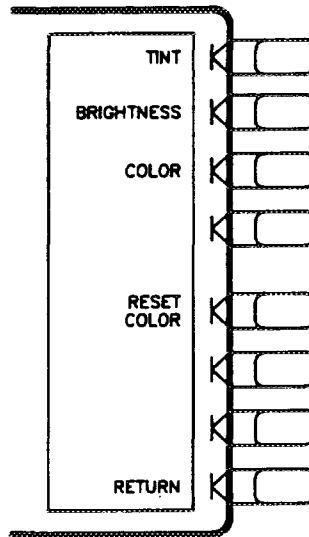

Figure 4-29. Color Adjust Menu

[TINT] (TINT) adjusts the continuum of hues on the color wheel of the chosen attribute. See *Adjusting Color* for an explanation of using this softkey for color modification of CRT display attributes.

[BRIGHTNESS] (CBRI) adjusts the brightness of the color being modified. See *Adjusting Color* for an explanation of using this softkey for color modification of CRT display attributes.

[COLOR] (COLOR) adjusts the degree of whiteness of the color being modified. See *Adjusting Color* for an explanation of using this softkey for color modification of CRT display attributes.

[RESET COLOR] (RSCO) resets the color being modified to the default color.

[RETURN] goes back to the modify colors menu.

Adjusting Color

This procedure explains how to adjust the colors on your analyzer CRT display. The default colors in this instrument have been scientifically chosen to maximize your ability to discern the difference between the colors, and to comfortably and effectively view the colors. These colors are recommended for normal use because they will provide a suitable contrast that is easy to view for along periods of time.

You may choose to change the default colors to suit environmental needs, individual preferences, or to accommodate color deficient vision. You can use any of the available colors for any of the seven CRT display elements listed by the softkey names below:

- **CH1 DATA/LIMIT LN]**
- **CH1 MEM]**
- **CH2 DATA/LIMIT LN]**
- **CH2 MEM/REF LINE]**
- **GRATICULE/TEXT]**
- **WARNING]**
- **TEXT]**

To change the color of a CRT display elements, press the softkey for that element (such as [CH1 DATA]). Then press [TINT] and turn the analyzer front panel knob, use the step keys or the numeric keypad, until the desired color appears.

Color is comprised of three parameters:

Tint - The continuum of hues on the color wheel, ranging from red, through green and blue, and back to red.

Brightness - A measure of the brightness of the color.

Color - The degree of whiteness of the color. A scale from white to pure color.

The most frequently occurring color deficiency is the inability to distinguish red, yellow, and green from one another. Confusion between these colors can usually be eliminated by increasing the brightness between the colors. To accomplish this, press the [BRIGHTNESS] softkey and turn the analyzer front panel knob. If additional adjustment is needed, vary the degree of whiteness of the color. To accomplish this, press the [COLOR] softkey and turn the analyzer front panel knob.

NOTE: Color changes and adjustments remain in effect until changed again in these menus or the analyzer is powered off and then on again. Cycling the power changes all color adjustments to default values. Preset does not affect color selection.

Setting Default Colors

To set all the CRT display elements to the factory-defined default colors, press:

[DISPLAY] [MORE] [ADJUST DISPLAY] [DEFAULT COLORS]

NOTE: [PRESET] does not reset or change colors to the default color values.

Saving Modified Colors

To save the modified color set, press:

[DISPLAY] [MORE] [ADJUST DISPLAY] [SAVE COLORS]

Modified colors are not part of a saved instrument state and are lost unless saved using these softkeys.

Recalling Modified Colors

To recall the previously saved color set, press:

[DISPLAY] [MORE] [ADJUST DISPLAY][RECALL COLORS]

Title Menu

Use this menu to specify a title for the active channel. The title identifies the display regardless of stimulus or response changes, and is printed or plotted with the data. If the display is saved in a register with the instrument state, the title is saved with it.

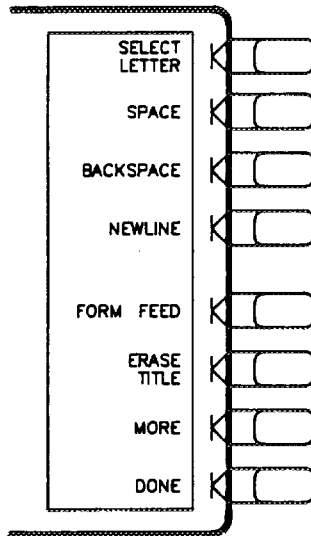

Figure 4-30. Title Menu

[SELECT LETTER]. The active entry area displays the letters of the alphabet, digits 0 through 9, and mathematical symbols. To define a title, rotate the knob until the arrow ↑ points at the first letter, then press **[SELECT LETTER]**. Repeat this until the complete title is defined, for a maximum of 50 characters. As each character is selected, it is appended to the title at the top of the graticule.

[SPACE] inserts a space in the title.

[BACK SPACE] deletes the last character entered.

[NEWLINE] sends a new line command to the printer.

[FORM FEED] advances the printer paper to the next page.

[ERASE TITLE] deletes the entire title.

[MORE] leads to the title more menu.

[DONE] terminates the title entry, and returns to the display more menu.

Title More Menu

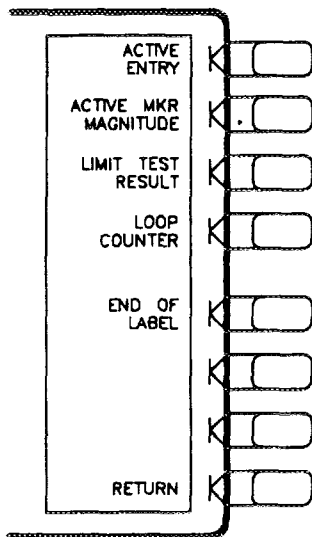

Figure 4-31. Title More Menu

The following softkeys cause the named data to be printed out with the title. This is especially useful when used with the test sequence function, described in Chapter 13.

[ACTIVE ENTRY] prints the name of the active entry.

[ACTIVE MRK AMPLITUDE] prints the active marker amplitude.

[LIMIT TEST RESULT] prints the result of a limit test.

[LOOP COUNTER] prints the current value of the loop counter. Refer to chapter 13.

[END OF LABEL] terminates the HP-GL "LB" command. Refer to chapter 13.

[RETURN] returns to the previous menu.

[AVG] KEY

The HP-IB programming command is shown in parenthesis following the key or softkey.

The **[AVG]** (MENUAVG) key is used to access three different noise reduction techniques: sweep-to-sweep averaging, display smoothing, and variable IF bandwidth. Any or all of these can be used simultaneously. Averaging and smoothing can be set independently for each channel, and the IF bandwidth can be set independently if the stimulus is uncoupled.

Averaging computes each data point based on an exponential average of consecutive sweeps weighted by a user-specified averaging factor. Each new sweep is averaged into the trace until the total number of sweeps is equal to the averaging factor, for a fully averaged trace. Each point on the trace is the vector sum of the current trace data and the data from the previous sweep. A high averaging factor gives the best signal-to-noise ratio, but slows the trace update time. Doubling the averaging factor reduces the noise by 3 dB. Averaging is used for ratioed measurements: if it is attempted for a single-input measurement (e.g. A or B), the message "CAUTION: AVERAGING INVALID ON NON-RATIO MEASURE" is displayed. Figure 4-32 illustrates the effect of averaging on a log magnitude format trace.

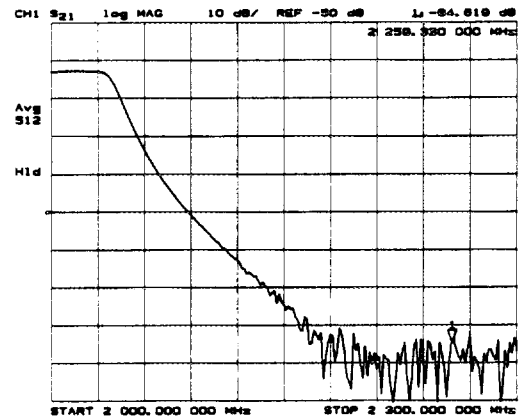
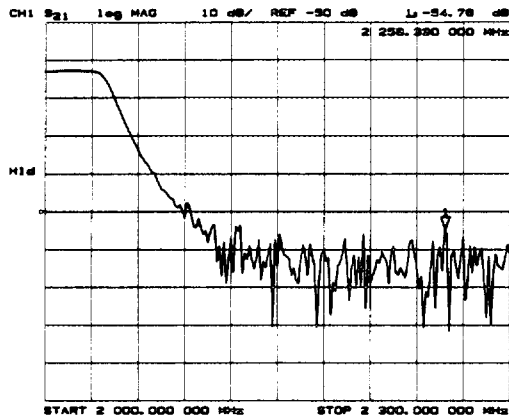

Figure 4-32. Effect of Averaging on a Trace

Smoothing (similar to video filtering) averages the formatted active channel data over a portion of the displayed trace. Smoothing computes each displayed data point based on one sweep only, using a moving average of several adjacent data points for the current sweep. The smoothing aperture is a percent of the stimulus span swept, up to a maximum of 20%.

Rather than lowering the noise floor, smoothing finds the mid-value of the data. Use it to reduce relatively small peak-to-peak noise values on broadband measured data. Use a sufficiently high number of display points to avoid misleading results. Do not use smoothing for measurements of high resonance devices or other devices with wide variations in trace, as it will introduce errors into the measurement.

Smoothing is used with Cartesian and polar display formats. It is also the primary way to control the group delay aperture, given a fixed frequency span (refer to *Group Delay Principles* earlier in this chapter). In polar display format, large phase shifts over the smoothing aperture will cause shifts in amplitude, since a vector average is being computed. Figure 4-33 illustrates the effect of smoothing on a log magnitude format trace.

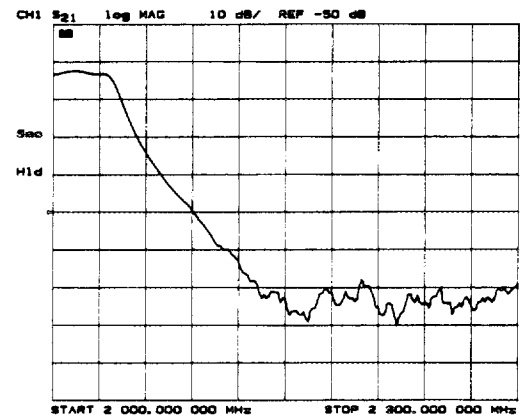
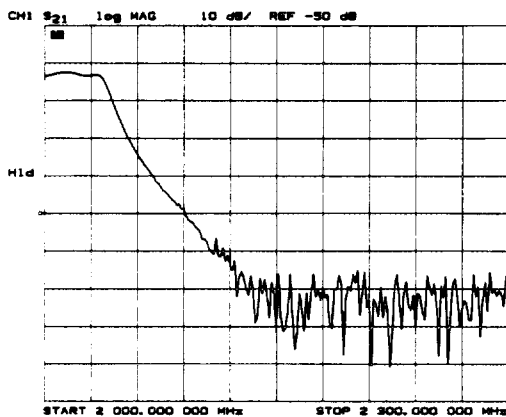

Figure 4-33. Effect of Smoothing on a Trace

IF Bandwidth Reduction lowers the noise floor by digitally reducing the receiver input bandwidth. It works in all ratio and non-ratio modes. It has an advantage over averaging in reliably filtering out unwanted responses such as spurs, odd harmonics, higher frequency spectral noise, and line-related noise. Sweep-to-sweep averaging, however, is better at filtering out very low frequency noise. A tenfold reduction in IF bandwidth lowers the measurement noise floor by about 10 dB. Bandwidths less than 300 Hz provide better harmonic rejection than higher bandwidths.

Another difference between sweep-to-sweep averaging and variable IF bandwidth is the sweep time. Averaging displays the first complete trace faster but takes several sweeps to reach a fully averaged trace. IF bandwidth reduction lowers the noise floor in one sweep, but the sweep time may be slower. Figure 4-34 illustrates the difference in noise floor between a trace measured with a 3000 Hz IF bandwidth and with a 10 Hz IF bandwidth.

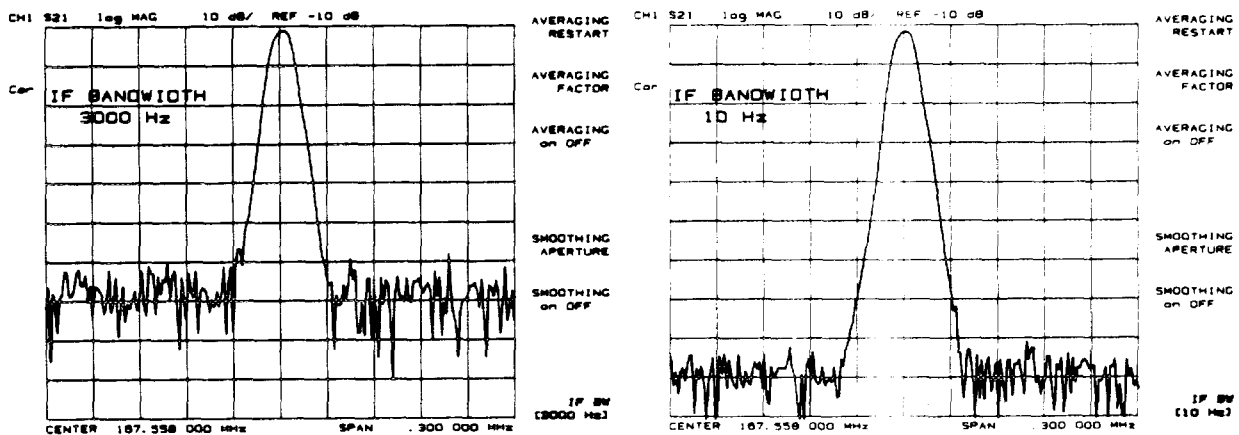

Figure 4-34. IF Bandwidth Reduction

Another capability that can be used for effective noise reduction is the marker statistics function, which computes the average value of part or all of the formatted trace. Refer to Chapter 6.

Another way of increasing dynamic range is to increase the input power to the device under test using an HP 8347A amplifier. Refer to the *User's Guide* for an example.

Average Menu

The average menu (Figure 4-35) is used to select the desired noise-reduction technique, and to set the parameters for the technique selected. It is also used to set the aperture for group delay measurements.

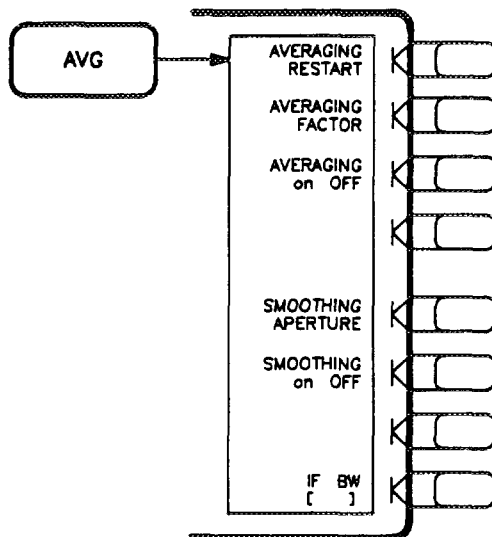

Figure 4-35. Average Menu

[AVERAGING RESTART] (AVERREST) resets the sweep-to-sweep averaging and restarts the sweep count at 1 at the beginning of the next sweep. The sweep count for averaging is displayed at the left of the CRT.

[AVERAGING FACTOR] (AVERFACT) makes averaging factor the active function. Any value up to 999 can be used. The algorithm used for averaging is:

$$A(n) = S(n)/F + (1-1/F) \times A(n-1)$$

where

A(n) = current average

S(n) = current measurement

F = average factor

[AVERAGING on OFF] (AVERON, AVEROFF) turns the averaging function on or off for the active channel. "Avg" is displayed in the status notations area at the left of the CRT, together with the sweep count for the averaging factor, when averaging is on. The sweep count for averaging is reset to 1 whenever an instrument state change affecting the measured data is made.

At the start of averaging or following **[AVERAGING RESTART]**, averaging starts at 1 and averages each new sweep into the trace until it reaches the specified averaging factor. The sweep count is displayed in the status notations area below "Avg" and updated every sweep as it increments. When the specified averaging factor is reached, the trace data continues to be updated, weighted by that averaging factor.

[SMOOTHING APERTURE]] (SMOOAPER) lets you change the value of the smoothing aperture as a percent of the span. When smoothing aperture is the active function, its value in stimulus units is displayed below its percent value in the active entry area.

Smoothing aperture is also used to set the aperture for group delay measurements (refer to *Group Delay Principles* earlier in this chapter). Note that the displayed smoothing aperture is not the group delay aperture unless smoothing is on.

[SMOOTHING on OFF] (SMOOON, SMOOOFF) turns the smoothing function on or off for the active channel. When smoothing is on, the annotation "Smo" is displayed in the status notations area.

[IF BW] ((FBW) is used to select the bandwidth value for IF bandwidth reduction. Allowed values (in Hz) are 3000, 1000, 300, 100, 30, and 10. Any other value will default to the closest allowed value. A narrow bandwidth slows the sweep speed but provides better signal-to-noise ratio. The selected bandwidth value is shown in brackets in the softkey label.

Chapter 5. Measurement Calibration

CHAPTER CONTENTS

5-1	Introduction	5-25	Full 2-Port Calibration for Reflection and Transmission Measurements
5-2	Accuracy Enhancement		
5-2	Sources of Measurement Errors	5-27	One-Port 2-Port Calibration for Reflection and Transmission Measurements
5-5	Correcting for Measurement Errors		
5-8	Frequency Response of Calibration Standards	5-28	Power Meter Calibration
5-10	Menus and Softkeys	5-30	Power Meter Calibration Modes of Operation
5-10	[CAL] Key	5-34	Using Power Meter Calibration
5-11	Interpolated Error Correction	5-36	Power Meter Calibration Menus
5-13	Correction Menu	5-38	Power Loss/Sensor Lists Menu
5-14	Select Cal Kit Menu	5-39	Segment Modify Menu
5-15	Calibrate More Menu	5-40	Segment Edit (Calibration Factor %) Menu
5-17	Reference Plane Menu	5-41	Segment Edit (Power Loss) Menu
5-18	Calibration Menu	5-41	Modifying Calibration Kits
5-20	Purpose and Use of Different Calibration Procedures (table)	5-43	Modify Cal Kit Menu
5-21	Response Calibration for Reflection Measurements	5-44	Define Standard Menus
5-22	Response Calibration for Transmission Measurements	5-46	Specify Offset Menu
5-22	Response and Isolation Calibration for Reflection Measurements	5-48	Label Standard Menu
5-23	Response and Isolation Calibration for Transmission Measurements	5-49	Specify Class Menus
5-24	S ₁₁ 1-Port Calibration for Reflection Measurements	5-51	Label Class Menus
5-25	S ₂₂ 1-Port Calibration	5-51	Label Kit Menu
		5-51	Verify Performance
		5-52	Example Procedure
		5-53	Appendix: Accuracy Enhancement Fundamentals
		5-53	One-Port Error Model
		5-59	Two-Port Error Model

INTRODUCTION

Measurement calibration is an accuracy enhancement procedure that effectively removes the system errors that cause uncertainty in measuring a device under test. It measures known standard devices, and uses the results of these measurements to characterize the system.

This chapter explains the theoretical fundamentals of accuracy enhancement and the sources of measurement errors. It describes the different measurement calibration procedures available in the analyzer, which errors they correct, and the measurements for which each should be used. An appendix at the end of this chapter provides further information on characterizing systematic errors and using error models to analyze overall measurement performance.

ACCURACY ENHANCEMENT

If it were possible for a perfect measurement system to exist, it would have infinite dynamic range, isolation, and directivity characteristics, no impedance mismatches in any part of the test setup, and flat frequency response. *Vector accuracy enhancement*, also known as *measurement calibration* or *error correction*, provides the means to simulate a perfect measurement system.

In any high frequency measurement there are measurement errors associated with the system that contribute uncertainty to the results. Parts of the measurement setup such as interconnecting cables and signal separation devices (as well as the analyzer itself) all introduce variations in magnitude and phase that can mask the actual performance of the device under test.

For example, crosstalk due to the channel isolation characteristics of the analyzer can contribute an error equal to the transmission signal of a high-loss test device. For reflection measurements, the primary limitation of dynamic range is the directivity of the test setup. The measurement system cannot distinguish the true value of the signal reflected by the device under test from the signal arriving at the receiver input due to leakage in the system. For both transmission and reflection measurements, impedance mismatches within the test setup cause measurement uncertainties that appear as ripples superimposed on the measured data.

Measurement calibration simulates a perfect analyzer system. It measures the magnitude and phase responses of known standard devices, and compares the measurement with actual device data. It uses the results to characterize the system and effectively remove the system errors from the measurement data of a test device, using vector math capabilities internal to the network analyzer.

When measurement calibration is used, the dynamic range and accuracy of the measurement are limited only by system noise and stability, connector repeatability, and the accuracy to which the characteristics of the calibration standards are known.

SOURCES OF MEASUREMENT ERRORS

Network analysis measurement errors can be separated into systematic, random, and drift errors.

Correctable systematic errors are the repeatable errors that the system can measure. These are errors due to mismatch and leakage in the test setup, isolation between the reference and test signal paths, and system frequency response.

The system cannot measure and correct for the non-repeatable random and drift errors. These errors affect both reflection and transmission measurements. Random errors are measurement variations due to noise and connector repeatability. Drift errors include frequency drift, temperature drift, and other physical changes in the test setup between calibration and measurement.

The resulting measurement is the vector sum of the device under test response plus all error terms. The precise effect of each error term depends upon its magnitude and phase relationship to the actual test device response.

In most high frequency measurements the systematic errors are the most significant source of measurement uncertainty. Since each of these errors can be characterized, their effects can be effectively removed to obtain a corrected value for the test device response. For the purpose of vector accuracy enhancement these uncertainties are quantified as directivity, source match, load match, isolation (crosstalk), and frequency response (tracking). Each of these systematic errors is described below.

Random and drift errors cannot be precisely quantified, so they must be treated as producing a cumulative uncertainty in the measured data.

Directivity

Normally a device that can separate the reverse from the forward traveling waves (a directional bridge or coupler) is used to detect the signal reflected from the device under test. Ideally the coupler would completely separate the incident and reflected signals, and only the reflected signal would appear at the coupled output, as illustrated in Figure 5-1a.

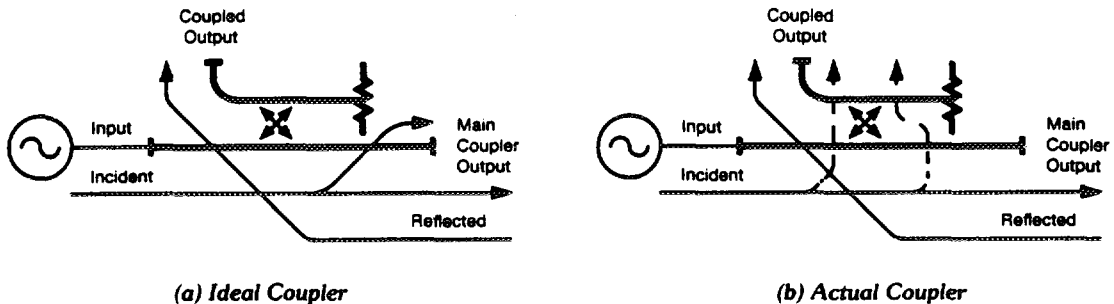

Figure 5-1. Directivity

However, an actual coupler is not perfect, as illustrated in Figure 5-1b. A small amount of the incident signal appears at the coupled output due to leakage as well as to reflection from the termination in the coupled arm. Also, reflections from the coupler output connector appear at the coupled output, adding uncertainty to the signal reflected from the device. The figure of merit for how well a coupler separates forward and reverse waves is directivity. The greater the directivity of the device, the better the signal separation. System directivity is the vector sum of all leakage signals appearing at the analyzer receiver input. The presence of these signals are due to the inability of the signal separation device to absolutely separate incident and reflected waves, and to residual reflection effects of test cables and adapters between the signal separation device and the measurement plane. The error contributed by directivity is independent of the characteristics of the test device and it usually produces the major ambiguity in measurements of low reflection devices.

Source Match

Source match is defined as the vector sum of signals appearing at the analyzer receiver input due to the impedance mismatch at the test device looking back into the source, as well as to adapter and cable mismatches and losses. In a reflection measurement, the source match error signal is caused by some of the reflected signal from the DUT being reflected from the source back toward the DUT and re-reflected from the DUT (Figure 5-2). In a transmission measurement, the source match error signal is caused by reflection from the test device that is re-reflected from the source. Source match is most often given in terms of return loss in dB: thus the larger the number, the smaller the error.

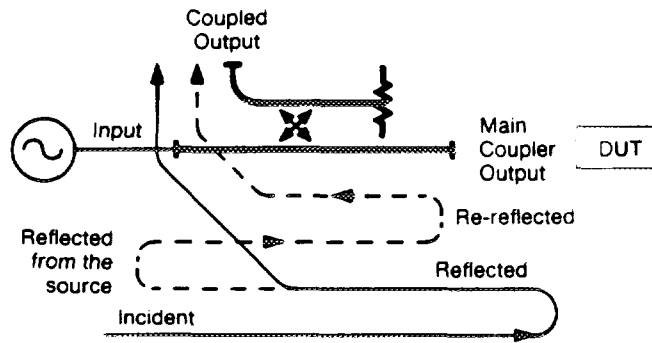

Figure 5-2. Source Match

The error contributed by source match is dependent on the relationship between the actual input impedance of the test device and the equivalent match of the source. It is a factor in both transmission and reflection measurements. Source match is a particular problem in measurements where there is a large impedance mismatch at the measurement plane.

Load Match

Load match error results from an imperfect match at the output of the test device. It is caused by impedance mismatches between the test device output port and port 2 of the measurement system. As illustrated in Figure 5-3, some of the transmitted signal is reflected from port 2 back to the test device. A portion of this wave may be re-reflected to port 2, or part may be transmitted through the device in the reverse direction to appear at port 1. If the DUT has low insertion loss (for example a transmission line), the signal reflected from port 2 and re-reflected from the source causes a significant error because the DUT does not attenuate the signal significantly on each reflection. Load match is usually given in terms of return loss in dB: thus the larger the number, the smaller the error.

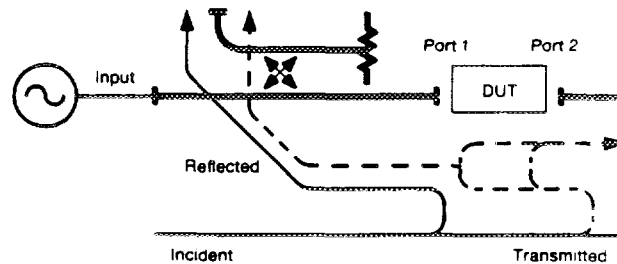

Figure 5-3. Load Match

The error contributed by load match is dependent on the relationship between the actual output impedance of the test device and the effective match of the return port (port 2). It is a factor in all transmission measurements and in reflection measurements of two-port devices. Load match and source match are usually ignored when the test device insertion loss is greater than about 6 dB, because the error signal is greatly attenuated each time it passes through the DUT. However, load match effects produce major transmission measurement errors for a test device with a highly reflective output port.

Isolation (Crosstalk)

Leakage of energy between analyzer signal paths contributes to error in a transmission measurement much like directivity does in a reflection measurement. Isolation is the vector sum of signals appearing at the analyzer samplers due to crosstalk between the reference and test signal paths. This includes signal leakage within the test set and in both the RF and IF sections of the receiver.

The error contributed by isolation depends on the characteristics of the device under test. Isolation is a factor in high-loss transmission measurements. However, analyzer system isolation is more than sufficient for most measurements, and correction for it may be unnecessary. For measuring devices with high dynamic range, accuracy enhancement can provide improvements in isolation that are limited only by the noise floor.

Frequency Response (Tracking)

This is the vector sum of all test setup variations in which magnitude and phase change as a function of frequency. This includes variations contributed by signal separation devices, test cables, and adapters, and variations between the reference and test signal paths. This error is a factor in both transmission and reflection measurements.

For further explanation of systematic error terms and the way they are combined and represented graphically in error models, refer to the appendix at the end of this chapter, titled *Accuracy Enhancement Fundamentals – Characterizing Microwave Systematic Errors*.

CORRECTING FOR MEASUREMENT ERRORS

There are twelve different error terms for a two-port measurement that can be corrected by accuracy enhancement in the analyzer. These are directivity, source match, load match, isolation, reflection tracking, and transmission tracking, each in both the forward and reverse direction. The analyzer has several different measurement calibration routines to characterize one or more of the systematic error terms and remove their effects from the measured data. The procedures range from a simple frequency response calibration to a full two-port calibration that effectively removes all twelve error terms.

The Response Calibration effectively removes the frequency response errors of the test setup for reflection or transmission measurements. This calibration procedure may be adequate for measurement of well matched low-loss devices. This is the simplest error correction to perform, and should be used when extreme measurement accuracy is not required.

The Response and Isolation Calibration effectively removes frequency response and crosstalk errors in transmission measurements, or frequency response and directivity errors in reflection measurements. This procedure may be adequate for measurement of well matched high-loss devices.

The S_{11} and S_{22} One-Port Calibration procedures provide directivity, source match, and frequency response vector error correction for reflection measurements. These procedures provide high accuracy reflection measurements of one-port devices or properly terminated two-port devices.

The Full Two-Port Calibration provides directivity, source match, load match, isolation, and frequency response vector error correction, in both forward and reverse directions, for transmission and reflection measurements of two-port devices. This calibration provides the best magnitude and phase measurement accuracy for both transmission and reflection measurements of two-port devices, and requires an S-parameter test set.

The One-Path Two-Port Calibration provides directivity, source match, load match, isolation, and frequency response vector error correction in one direction. It is used for high accuracy transmission and reflection measurements using a transmission/reflection test set, such as the HP 85044A. (The device under test must be manually reversed between sweeps to accomplish measurements in both the forward and reverse directions.)

All the calibration procedures described above are accessed from the [CAL] key and are described in the following pages.

The uncorrected performance of the analyzer is sufficient for many measurements. However, the vector accuracy enhancement techniques described in this chapter will provide a much higher level of accuracy. Figures 5-4, 5-5, and 5-6 illustrate the improvements that can be made in measurement accuracy by using a more complete calibration routine. Figure 5-4a shows a measurement in log magnitude format with a response calibration only. Figure 5-4b shows the improvement in the same measurement using an S_{11} one-port calibration. Figure 5-5a shows the measurement on a Smith chart with response calibration only, and Figure 5-5b shows the same measurement with an S_{11} one-port calibration.

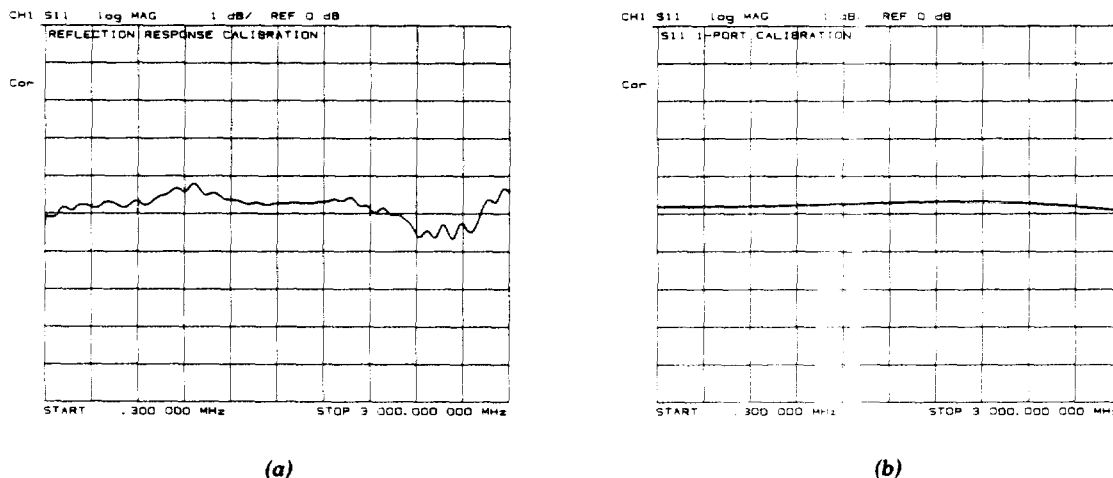

Figure 5-4. Response vs. S_{11} 1-Port Calibration on Log Magnitude Format

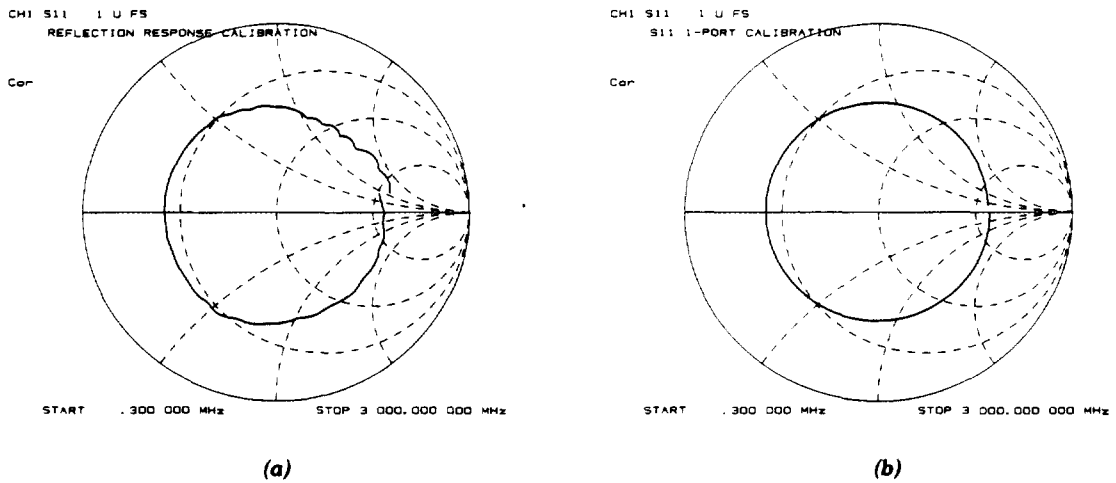

Figure 5-5. Response vs. S_{11} 1-Port Calibration on Smith Chart

Figure 5-6 shows the response of a low-loss device in a log magnitude format, using a response calibration in Figure 5-6a and a full two-port calibration in Figure 5-6b.

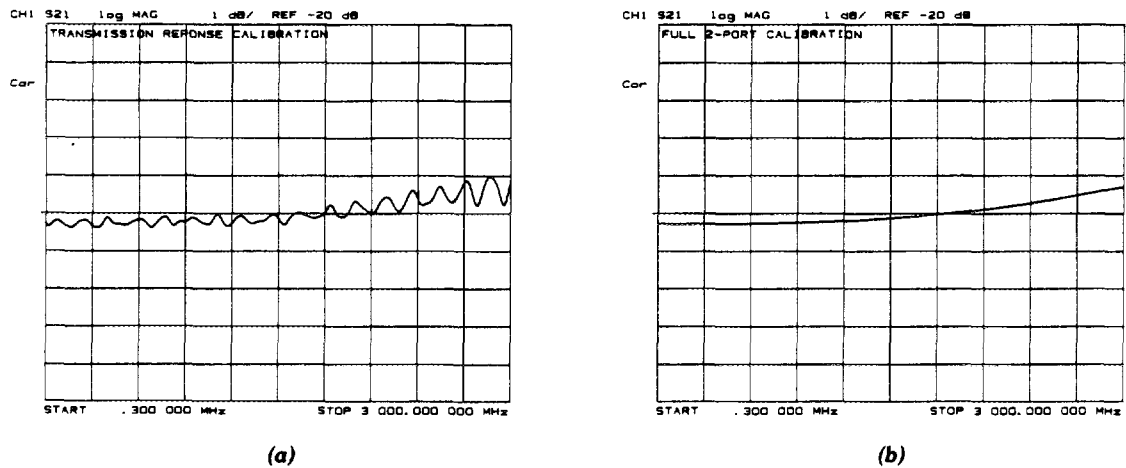

Figure 5-6. Response vs. Full Two-Port Calibration

After the correctable systematic errors are effectively removed using accuracy enhancement, residual uncertainties remain. In addition to random and drift errors, these include residual systematic errors resulting from imperfections in the calibration standards, the connector interface, the interconnecting cables, and the instrumentation. Refer to *System Performance* in the *General Information and Specifications* section of this manual. This provides information for calculating the system's total error-corrected measurement uncertainty performance.

Frequency Response of Calibration Standards

In order for the response of a reference standard to show as a dot on the display, it must have no phase shift with respect to frequency. Standards that exhibit such "perfect" response are the following:

- 7 mm short (with no offset)
- Type-N male short (with no offset)

There are two reasons why other types of reference standards show phase shift after calibration:

- The reference plane of the standard is electrically offset from the mating plane of the test port. Such devices exhibit the properties of a small length of transmission line, including a certain amount of phase shift.
- The standard is an open termination, which by definition exhibits a certain amount of fringe capacitance (and therefore phase shift). Open terminations which are offset from the mating plane will exhibit a phase shift due to the offset in addition to the phase shift caused by the fringe capacitance.

The most important point to remember is that these properties will not affect your measurements. The analyzer compensates for them during measurement. Figure 5-7 shows sample displays of various calibration standards after calibration.

Electrical Offset. Some standards have reference planes that are electrically offset from the mating plane of the test port. These devices will show a phase shift with respect to frequency. The master reference table (Table 5-1) shows which reference devices exhibit an electrical offset phase shift. The amount of phase shift can be calculated with the formula:

$$\phi = (360 \times f \times l)/c \text{ where:}$$

f = frequency

l = electrical length of the offset

c = speed of light (3×10^8 meters/second).

Fringe Capacitance. All open circuit terminations exhibit a phase shift over frequency due to fringe capacitance. Offset open circuits have increased phase shift because the offset acts as a small length of transmission line. Refer to the master reference table.

Table 5-1. Master Reference Table Showing Calibration Standard Types and Expected Phase Shift

Test Port Connector Type	Standard Type	Expected Phase Shift
7 mm type-N male	Short	180° (ideal)
3.5 mm male 3.5 mm female type-N female	Offset Short	$180^\circ + (360 \times f \times l)/c$
7 mm type-N male	Open	$0^\circ + \phi_{\text{capacitance}}$
3.5 mm male 3.5 mm female type-N female	Offset Open	$0^\circ + \phi_{\text{capacitance}} + (360 \times f \times l)/c$

NOTE: The sex associated with a reference standard refers to the sex of the test port, not the sex of the standard itself.

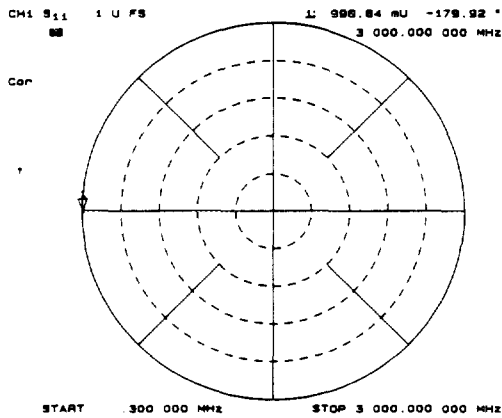

**7 mm or Type-N Male
Short (No Offset)**

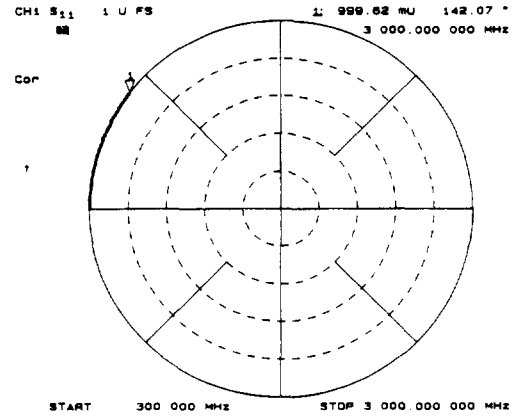

**Type-N Female,
3.5 mm Male or Female Offset Short**

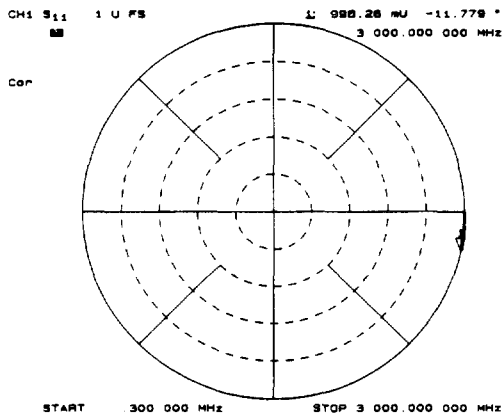

**7 mm or Type-N Male
Open (No Offset)**

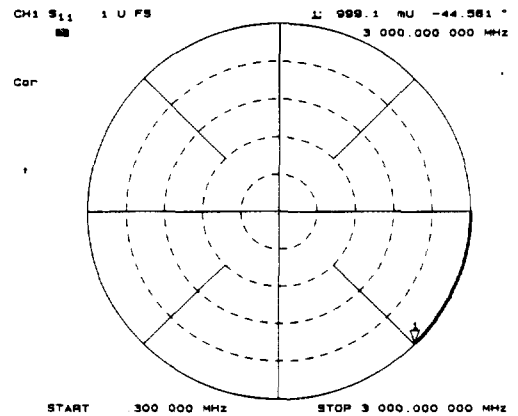

**Type-N Female,
3.5 mm Male or Female Offset Open**

Figure 5-7. Typical Responses of Calibration Standards after Calibration

MENUS AND SOFTKEYS

[CAL] Key

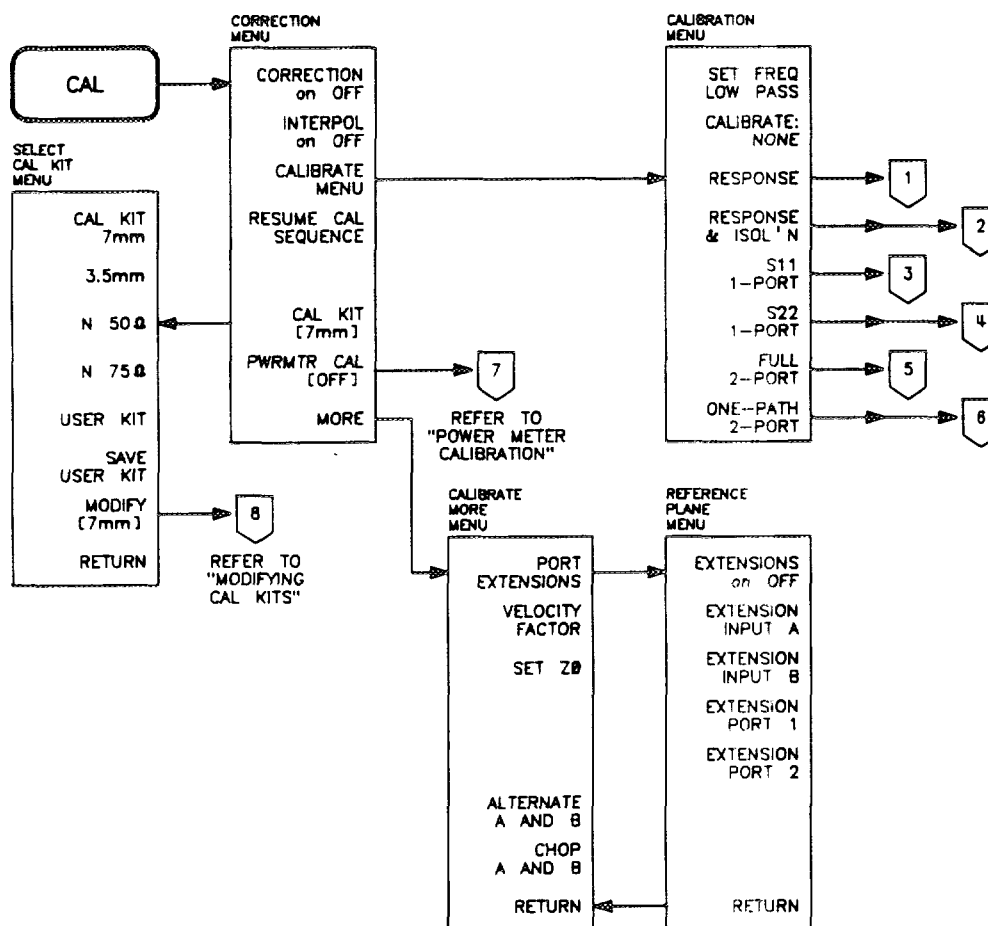

Figure 5-8. Softkey Menus Accessed from the [CAL] Key

The HP-IB programming command is shown in parenthesis following the key or softkey.

The [CAL] (MENCAL) key leads to a series of menus that implement the accuracy enhancement procedures described in the preceding pages (see Figure 5-8). Accuracy enhancement (error correction) is performed as a calibration step before measurement of a test device. The analyzer uses one of several different procedures to measure the systematic (repeatable) errors of the system and remove their effects from the measured data. The calibration menus and procedures are described and illustrated in the following pages. Each procedure compensates for one or more of the systematic error terms. These range from a simple response calibration that removes the frequency response errors of the test setup to a full two-port vector calibration that removes all twelve error terms. Measurements of standard devices are used to solve for the error terms.

Standard Devices. The standard devices required for system calibration are available in compatible calibration kits with different connector types. The model numbers and contents of these calibration kits are listed in the *General Information and Specifications* section of this manual. Each kit contains at least one short circuit, one open circuit, and two impedance-matched loads. In kits that require adapters for interface to the test set ports, the adapters are phase-matched for calibration prior to measurement of non-insertable and non-reversible devices. Other standard devices can be used by specifying their characteristics in a user-defined kit, as described later in this chapter under *Modifying Calibration Kits*.

The accuracy improvement of the correction is limited by the quality of the standard devices, and by the connection techniques used. For information about connector care and connection techniques, refer to *Principles of Microwave Connector Care*. This document is provided in this manual behind the Accessories tab. For maximum accuracy, use a torque wrench for final connections. The techniques for torquing connections and the part numbers for torque wrenches recommended for different connector types are provided in the connector care documents listed above.

Calibration Validity. Unless interpolated error correction is on, measurement calibrations are valid only for a specific stimulus state, which must be set before calibration is begun. The stimulus state consists of the selected frequency range, number of points, sweep time, output power, and sweep type. Changing the frequency range, number of points, or sweep type with correction on invalidates the calibration and turns it off. Changing the sweep time or output power changes the status notation "Cor" at the left of the screen to "C?", to indicate that the calibration is in question. If correction is turned off or in question after the stimulus changes are made, pressing **[CORRECTION ON]** recalls the original stimulus state for the current calibration.

Interpolated Error Correction. The interpolated error correction feature allows the operator to select a subset of the frequency range or a different number of points without recalibration. Interpolation is activated by softkey. When interpolation is on, the system errors for the newly selected frequencies are calculated from the system errors of the original calibration.

System performance is unspecified when using interpolated error correction. The quality of the interpolated error correction is dependent on the amount of phase shift and the amplitude change between measurement points. If phase shift is no greater than 180° per approximately 5 measurement points, interpolated error correction offers a great improvement over uncorrected measurements. The accuracy of interpolated error correction improves as the phase shift and amplitude change between adjacent points decrease. When using the analyzer in linear frequency sweep with an HP 85046A/B or 85047A test set, it is recommended that the original calibration be performed with at least 67 points per 1 GHz of frequency span.

Interpolated error correction functions in three sweep modes: linear frequency, power sweep, and CW time.

If there is a valid correction array for a linear frequency sweep, this may be interpolated to provide correction at the CW frequency used in power sweep or CW time modes. This correction is part of the interpolated error correction feature and is not specified.

Channel Coupling. Up to two sets of measurement calibration data can be defined for each instrument state, one for each channel. If the two channels are stimulus coupled and the input ports are the same for both channels, they share the same calibration data. If the two channel inputs are different, they can have different calibration data. If the two channels are stimulus uncoupled, the measurement calibration applies to only one channel. For information on stimulus coupling, refer to Chapter 3, *Stimulus Function Block*.

Measurement Parameters. Calibration procedures are parameter-specific, rather than channel-specific. When a parameter is selected, the instrument checks the available calibration data, and uses the data found for that parameter. For example, if a transmission response calibration is performed for B/R, and an S_{11} 1-port calibration for A/R, the analyzer retains both calibration sets and corrects whichever parameter is displayed. Once a calibration has been performed for a specific parameter or input, measurements of that parameter remain calibrated in either channel, as long as stimulus values are coupled. In the response and response and isolation calibrations, the parameter must be selected before calibration: other correction procedures select parameters automatically. Changing channels during a calibration procedure invalidates the part of the procedure already performed.

Device Measurements. In procedures that require measurement of several different devices, for example a short, an open, and a load, the order in which the devices are measured is not critical. Any standard can be re-measured, until the **[DONE]** key is pressed. The change in trace during measurement of a standard is normal.

Response and response and isolation calibrations require measurement of only one standard device. If more than one device is measured, only the data for the last device is retained.

Omitting Isolation Calibration. Isolation calibration can be omitted for most measurements, except where wide dynamic range is a consideration. Use the following guidelines. When the measurement requires a dynamic range of:

- 80 dB: Omit isolation calibration for most measurements.
- 80 to 100 dB: Isolation calibration is recommended with approximately 0 dBm into the R input.
- 100 dB: Averaging should be on with an averaging factor ≥ 16 , both for isolation calibration and for measurement after calibration.

Restarting a Calibration. A calibration that is interrupted to go to another menu can be continued with the **[RESUME CAL SEQUENCE]** key in the correction menu.

Saving Calibration Data. It is recommended that calibration data be saved, either in internal volatile memory or on an external disk. Refer to Chapter 10, *Saving Instrument States*. If a calibration is not saved, it will be lost if another calibration procedure is selected for the same channel, or if stimulus values are changed. Instrument preset, power on, and instrument state recall will also clear the calibration data.

Specifying Calibration Kits. In addition to the menus for the different calibration procedures, the **[CAL]** key provides access to a series of menus used to specify the characteristics of the calibration standards used. Several default calibration kits with different connector types are predefined, or the definitions can be modified to any set of standards used.

Correction Menu

The correction menu is the first menu presented by the [CAL] key, and it provides access to numerous menus of additional calibration features.

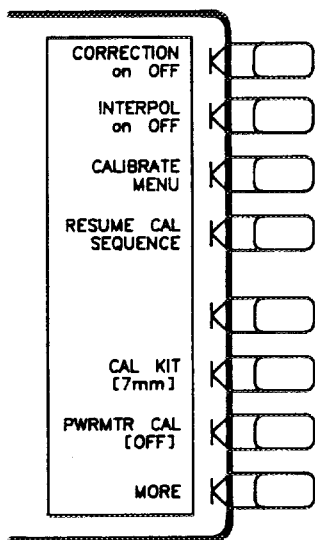

Figure 5-9. Correction Menu

[CORRECTION on OFF] (CORRON, CORROFF) turns error correction on or off. The analyzer uses the most recent calibration data for the displayed parameter. If the stimulus state has been changed since calibration, the original state is recalled, and the message "SOURCE PARAMETERS CHANGED" is displayed.

A calibration must be performed before correction can be turned on. If no valid calibration exists, the message "CALIBRATION REQUIRED" is displayed on the CRT. If interpolated error correction is on, this message is not displayed if you have selected a subset of a previously calibrated frequency range. See the **[INTERPOL on OFF]** description, below.

It is recommended that calibration data be saved, either in internal volatile memory or on an external disk, using capabilities described in Chapter 10, *Saving Instrument States*.

[INTERPOL on OFF] (CORION, CORIOFF) turns interpolated error correction on or off. The interpolated error correction feature allows the operator to calibrate the system, then select a subset of the frequency range or a different number of points. Interpolated error correction functions in linear frequency, power sweep and CW time modes. When using the analyzer in linear sweep with an HP 85046A/B or 85047A test set, it is recommended that the original calibration be performed with at least 67 points per 1 GHz of frequency span.

[CALIBRATE MENU] leads to the calibration menu, which provides several accuracy enhancement procedures ranging from a simple frequency response calibration to a full two-port calibration. At the completion of a calibration procedure, this menu is returned to the screen, correction is automatically turned on, and the notation "Cor" or "C2" is displayed at the left of the screen.

[RESUME CAL SEQUENCE] (RESC) eliminates the need to restart a calibration sequence that was interrupted to access some other menu. This softkey goes back to the point where the calibration sequence was interrupted.

[CAL KIT] leads to the select cal kit menu, which is used to select one of the default calibration kits available for different connector types. This, in turn, leads to additional menus used to define calibration standards other than those in the default kits (refer to *Modifying Calibration Kits*, later in this chapter). When a calibration kit has been specified, its connector type is displayed in brackets in the softkey label.

[PWR METER CAL] leads to the power meter calibration menu which provides two types of power meter calibration, continuous and single-sample. Power meter calibration is described later in this chapter.

[MORE] provides access to the calibrate more menu, which is used to extend the test port reference plane, to specify the characteristic impedance of the system, to select the optimum receiver sweep mode, and to specify the relative propagation velocity factor for distance-to-fault measurements using the time domain option.

Select Cal Kit Menu

The select cal kit menu is used to select the calibration kit for a measurement calibration. Selecting a cal kit chooses the model that mathematically describes the standard devices actually used. (Refer to the beginning of this chapter, and the appendix at the end of this chapter, for more background on measurement calibrations and error correction.)

The analyzer has the capability to calibrate with four default cal kits in four different connector types. The models for these cal kits correspond to the standard calibration kits available as accessories:

7 mm	HP 85031B 7 mm calibration kit
3.5 mm	HP 85033C 3.5 mm calibration kit
N 50 Ω	HP 85032B 50 ohm type-N calibration kit
N 75 Ω	HP 85036B 75 ohm type-N calibration kit

Cal kits other than those listed can be used. For example: The errors introduced by using the internal 7 mm model with a Hewlett-Packard 7 mm cal kit other than the HP 85031B are very small. For the highest accuracy, the more closely the model matches the device, the better.

In addition to the four default cal kits, a fifth choice is a "user kit" that is defined or modified by the user. This is described under *Modifying Calibration Kits* later in this chapter.

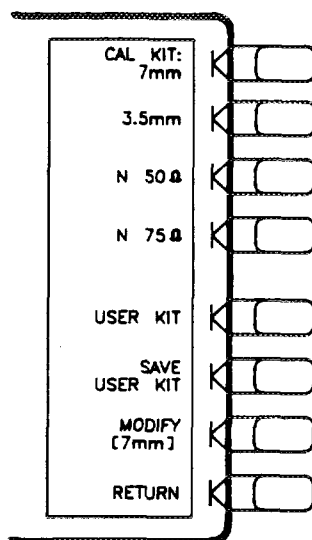

Figure 5-10. Select Cal Kit Menu

[CAL KIT: 7mm] (CALK7MM) selects the 7 mm cal kit model.

[3.5mm] (CALK35MM) selects the 3.5 mm cal kit model.

[N 50Ω] (CALKN50) selects the 50 ohm type-N model.

[N 75Ω] (CALKN75) selects the 75 ohm type-N model.

NOTE: If **[N 50Ω]** or **[N 75Ω]** is selected, additional menus are provided during calibration procedures to select the connector sex. (This is the connector sex of the input port, not the actual calibration standard.)

[USER KIT] (CALKUSED) selects a cal kit model defined or modified by the user. For information, refer to *Modifying Calibration Kits*, later in this chapter.

[SAVE USER KIT] (SAVEUSEK) stores the user-modified or user-defined kit into memory, after it has been modified.

[MODIFY] (MODI1) leads to the modify cal kit menu, where a default cal kit can be user-modified.

[RETURN] returns to the correction menu.

Calibrate More Menu

This menu is used to extend the test port reference plane, to specify the characteristic impedance of the system, to select the optimum receiver sweep mode, and to specify the relative propagation velocity factor for distance-to-fault measurements.

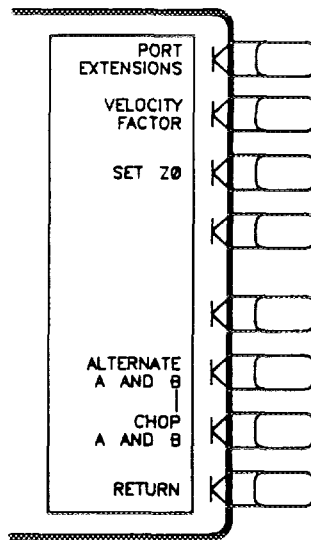

Figure 5-11. Calibrate More Menu

[**PORT EXTENSIONS**] goes to the reference plane menu, which is used to extend the apparent location of the measurement reference plane or input.

The differences between the [**PORT EXTENSIONS**] and [**ELECTRICAL DELAY**] functions are shown in the following table.

Table 5-2. Differences between [**PORT EXTENSIONS**] and [**ELECTRICAL DELAY**]

	[PORT EXTENSIONS]	[ELECTRICAL DELAY]
Main Effect	The end of a cable becomes the test port plane for all S-parameter measurements.	Compensates for the electrical length of a cable for the current type of measurement only. Reflection = 2 times cable's electrical length. Transmission = 1 times cable's electrical length.
Measurements Affected	All S-parameters.	Only the currently selected S-parameter.
Electrical Compensation	Intelligently compensates for 1 times or 2 times the cable's electrical delay, depending on which S-parameter is computed.	Only compensates as necessary for the currently selected S-parameter.

[**VELOCITY FACTOR**] (VELOFACT) Enters the velocity factor used by the analyzer to calculate equivalent electrical length in distance-to-fault measurements using the time domain option. Values entered should be less than 1. For example, the velocity factor of teflon is:

$$V_t = \frac{1}{\sqrt{\epsilon_R}} = 0.666$$

[**SET Z0**] (SETZ) sets the characteristic impedance used by the analyzer in calculating measured impedance with Smith chart markers and conversion parameters. If the test set used is an HP 85046B S-parameter Test Set or an HP 85044B Transmission/Reflection Test Set, set Z0 to 75 ohms. Characteristic impedance must be set correctly before calibration procedures are performed.

[ALTERNATE A and B] (ALTAB) measures only one input per frequency sweep, in order to reduce spurious signals. Thus, this mode optimizes the dynamic range for all four S-parameter measurements. This is the default measurement mode.

The disadvantages of this mode are associated with simultaneous transmission/reflection measurements or full two-port calibrations: this mode takes twice as long as the chop mode to make these measurements. In addition, the port match changes due to either input A or B being inactive during each sweep, which are in the order of < -55 dB, may affect transmission measurements.

[CHOP A and B] (CHOPAB) measures both inputs A and B during each sweep. Thus, if each channel is measuring a different parameter and both channels are displayed, the chop mode offers the fastest measurement time. This is the preferred measurement mode for full two-port calibrations because both inputs remain active.

The disadvantage of this mode is that in measurements of high rejection devices, such as filters with a low-loss passband (> 400 MHz wide), maximum dynamic range may not be achieved.

NOTE: If more dynamic range is desired for a measurement of S_{21} , in either the chop or the alternate mode, a 10 dB attenuator can be connected to input A and another to input R. This improves the crosstalk into input B. The dynamic range of input B is increased, but the usable dynamic range of input A is reduced.

[RETURN] goes back to the correction menu.

Reference Plane Menu

This menu adds electrical delay in seconds to the measurement ports to extend the apparent location of the measurement reference plane to the ends of the cables. This is equivalent to adding a length of perfect air line, and makes it possible to measure the delay response of the device only instead of the device plus the cable.

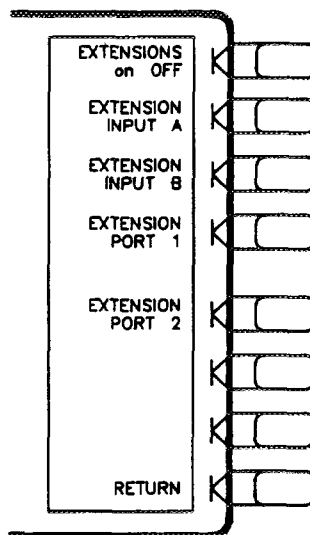

Figure 5-12. Reference Plane Menu

[EXTENSIONS on OFF] (POREON, POREOFF) toggles the reference plane extension mode. When this function is on, all extensions defined below are enabled; when off, none of the extensions is enabled.

[EXTENSION INPUT A] (PORTA). Use this feature to add electrical delay in seconds to extend the reference plane at input A to the end of the cable. This is used for any input measurements including S-parameters.

[EXTENSION INPUT B] (PORTB) adds electrical delay to the input B reference plane for any B input measurements including S-parameters.

[EXTENSION PORT 1] (PORT1) extends the reference plane for measurements of S_{11} , S_{21} , and S_{12} .

[EXTENSION PORT 2] (PORT2) extends the reference plane for measurements of S_{22} , S_{12} , and S_{21} .

[RETURN] goes back to the calibrate more menu.

Calibration Menu

The calibration menu is used to select the appropriate accuracy enhancement procedure for calibration before a measurement is performed. Six different calibration routines are available, each of which effectively removes from one to twelve systematic errors from the measurement data. Each calibration procedure features CRT prompts to guide you through the calibration sequence. The available calibrations are described below, and a comparative summary is provided in Table 5-3. Procedures for performing each of the calibrations are provided in the following pages, together with illustrations of the corresponding menus.

Note that all instrument parameters should be established before a calibration procedure is started, including stimulus values, calibration kit, system characteristic impedance Z_0 , and receiver sweep mode. (To modify the characteristic impedance and receiver sweep mode, refer to *Calibrate More Menu*.) If interpolated error correction is on, and you are in linear frequency sweep, power sweep, or CW time sweep, you may choose a subset of frequency range or a different number of points after the system has been calibrated. The performance of interpolated error correction is not specified.

NOTE: By convention, when the connector sex is provided in parentheses for a calibration standard, it refers to the sex of the test port connector, not the sex of the standard. For example, short (m) indicates that the test port connector is male, not the short circuit connector.

NOTE: The compatible type-N and 3.5 mm calibration kits for the analyzer provide open circuits with center conductor extenders. For maximum accuracy in calibration with these devices, follow these steps: First connect the outer conductor by hand and torque wrench. Then insert the center conductor extender into the outer conductor. The fit should be snug but free. Push gently until the center conductors mate.

For measurement of test devices following calibration, refer to the *User's Guide*.

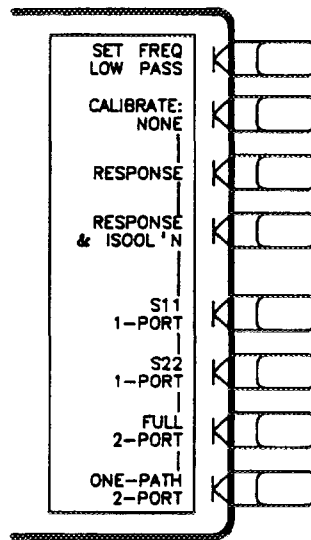

Figure 5-13. Calibration Menu

[SET FREQ LOW PASS] changes the frequency sweep to harmonic intervals to accommodate time domain low-pass operation (option 010). If this mode is used, the frequencies must be set before calibration. Refer to Chapter 8, *Time and Frequency Domain Transforms*, for more information.

[CALIBRATE: NONE] is underlined if no calibration has been performed or if the calibration data has been cleared. Unless a calibration is saved in memory, the calibration data is lost on instrument preset, power on, instrument state recall, or if stimulus values are changed.

[RESPONSE] (CALIRESP) leads to the frequency response calibration. This is the simplest and fastest accuracy enhancement procedure, but should be used when extreme accuracy is not required. It effectively removes the frequency response errors of the test setup for reflection or transmission measurements.

For transmission-only measurements or reflection-only measurements, only a single calibration standard is required with this procedure. The standard for transmission measurements is a thru, and for reflection measurements can be either an open or a short. If more than one device is measured, only the data for the last device is retained. The procedures for response calibration for a reflection measurement and a transmission measurement are described in the following pages.

[RESPONSE & ISOL'N] (CALIRAI) leads to the menus used to perform a response and isolation measurement calibration, for measurement of devices with wide dynamic range. This procedure effectively removes the same frequency response errors as the response calibration. In addition, it effectively removes the isolation (crosstalk) error in transmission measurements or the directivity error in reflection measurements. As well as the devices required for a simple response calibration, an isolation standard is required. The standard normally used to correct for isolation is an impedance-matched load (usually 50 or 75 ohms). Response and directivity calibration procedures for reflection and transmission measurements are provided in the following pages.

[S11 1-PORT] (CALIS111) provides a measurement calibration for reflection-only measurements of one-port devices or properly terminated two-port devices, at port 1 of an S-parameter test set or the test port of a transmission/reflection test set. This procedure effectively removes the directivity, source match, and frequency response errors of the test setup, and provides a higher level of measurement accuracy than the response and isolation calibration. It is the most accurate calibration procedure for reflection-only measurements. Three standard devices are required: a short, an open, and an impedance-matched load. The procedure for performing an S_{11} one-port calibration is described in the following pages.

[S22 1-PORT] (CALIS221) is similar to **[S11 1-PORT]**. It is used for reflection-only measurements of one-port devices or properly terminated two-port devices in the reverse direction: that is, for devices connected to port 2 of the S-parameter test set.

[FULL 2-PORT] (CALIFUL2) leads to the series of menus used to perform a complete calibration for measurement of all four S-parameters of a two-port device. This is the most accurate calibration for measurements of two-port devices. It effectively removes all correctable systematic errors (directivity, source match, load match, isolation, reflection tracking, and transmission tracking) in both the forward and the reverse direction. Isolation correction can be omitted for measurements of devices with limited dynamic range.

The standards for this procedure are a short, an open, a thru, and an impedance-matched load (two loads if isolation correction is required). An S-parameter test set is required. The procedure is described in the following pages.

[ONE-PATH 2-PORT] (CALIONE2) leads to the series of menus used to perform a high-accuracy two-port calibration without an S-parameter test set. This calibration procedure effectively removes directivity, source match, load match, isolation, reflection tracking, and transmission tracking errors in one direction only. Isolation correction can be omitted for measurements of devices with limited dynamic range. (The device under test must be manually reversed between sweeps to accomplish measurement of both input and output responses.) The required standards are a short, an open, a thru, and an impedance-matched load. The procedure for performing a one-path 2-port calibration is described in the following pages.

Table 5-3. Purpose and Use of Different Calibration Procedures

Calibration Procedure	Corresponding Measurement	Errors Removed	Standard Devices
Response	Transmission or reflection measurement when the highest accuracy is not required.	Freq. response	Thru for trans., open or short for reflection
Response & isolation	Transmission of high insertion loss devices or reflection of high return loss devices. Not as accurate as 1-port or 2-port calibration.	Freq. response <i>plus</i> isolation in transmission or directivity in reflection	Same as response <i>plus</i> isolation std (load)
S_{11} 1-port	Reflection of any one-port device or well terminated two-port device.	Directivity, source match, freq. response.	Short <i>and</i> open <i>and</i> load
S_{22} 1-port	Reflection of any one-port device or well terminated two-port device.	Directivity, source match, freq. response.	Short <i>and</i> open <i>and</i> load
Full 2-port	Transmission or reflection of highest accuracy for two-port devices. HP 85046A/B or 85047A S-parameter Test Set is required.	Directivity, source match, load match, isolation, freq. response, forward and reverse.	Short <i>and</i> open <i>and</i> load <i>and</i> thru (2 loads for isolation)
One-path 2-port	Transmission or reflection of highest accuracy for two-port devices. (Reverse test device between forward and reverse measurements.)	Directivity, source match, load match, isolation, freq. response, forward direction only.	Short <i>and</i> open <i>and</i> load <i>and</i> thru

Response Calibration for Reflection Measurements

This procedure uses the menu illustrated in Figure 5-14 to perform a frequency response only calibration with an S-parameter test set for a measurement of S_{11} . It can also be used for S_{22} by substituting the corresponding softkey in the S-parameters menu.

A similar procedure can be performed with a transmission/reflection test set, using the input ports menu instead of the S-parameters menu (described in Chapter 4, *Response Function Block*).

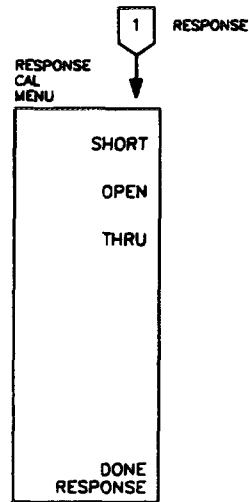

Figure 5-14. Response Cal Menu

- Press **[MEAS]** [*Ref: FWD S11 A/R*].
- Press **[CAL]**.
- Select the proper calibration kit. If the connector type or cal kit name shown in the **[CAL KIT]** softkey label is not the same as the calibration kit to be used, refer to *Select Cal Kit Menu*.
- Press **[CALIBRATE MENU]** [**RESPONSE**].
- At port 1, connect either a short or a shielded open circuit.
- When the trace settles, press **[SHORT]** or **[OPEN]**, depending on the standard used. (If more than one device is measured, only the data for the last device is retained.)
- The message "WAIT - MEASURING CAL STANDARD" is displayed while the data is measured. The softkey label **[SHORT]** or **[OPEN]** is then underlined.
- Press **[DONE: RESPONSE]**. The error coefficients are computed and stored. The correction menu is displayed with **[CORRECTION ON]**. A corrected trace is displayed.
- This completes the response calibration for a reflection measurement. Now the test device can be connected and measured.

It is recommended that calibration data be saved, either in internal volatile memory or on an external disk. Refer to Chapter 10, *Saving Instrument States*.

Response Calibration for Transmission Measurements

The procedure described here uses the menu in Figure 5-14 to perform a frequency response only calibration with an S-parameter test set for a measurement of S_{21} . To calibrate for a combined transmission and reflection measurement, perform the transmission calibration on one channel and the reflection calibration described above on the other channel.

A similar procedure can be performed with a transmission/reflection test set, using the input ports menu instead of the S-parameters menu (see Chapter 4, *Response Function Block*).

- Press [MEAS] [*Trans: FWD S21 B/R*].
- Press [CAL].
- Select the proper calibration kit. If the connector type or cal kit name shown in the [CAL KIT] softkey label is not the same as the calibration kit to be used, refer to *Select Cal Kit Menu*.
- Press [CALIBRATE MENU] [RESPONSE].
- Make a thru connection (connect together the points at which the test device will be connected).
- When the trace settles, press [THRU].
- The message "WAIT - MEASURING CAL STANDARD" is displayed while the S_{21} data is measured. The softkey label [THRU] is then underlined.
- Press [DONE: RESPONSE]. The error coefficients are computed and stored. The correction menu is displayed with [CORRECTION ON]. Corrected S_{21} data is displayed.
- This completes the response calibration for a transmission measurement. Now the test device can be connected and measured.

It is recommended that calibration data be saved, either in internal volatile memory or on an external disk. Refer to Chapter 10, *Saving Instrument States*.

Response and Isolation Calibration for Reflection Measurements

The procedure described here effectively removes the frequency response and directivity errors for reflection measurements. The menus illustrated in Figure 5-15 are used to perform a calibration with an S-parameter test set for a measurement of S_{11} . The same calibration can be used for S_{22} by substituting the corresponding softkey in the S-parameters menu.

A similar procedure can be performed with a transmission/reflection test set, using the input ports menu instead of the S-parameters menu (described in Chapter 4, *Response Function Block*).

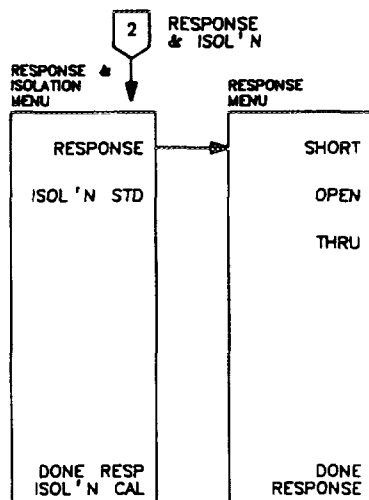

Figure 5-15. Response and Isolation Menu and Response Menu

- Press **[MEAS]** [*Ref: FWD S11 A/R*].
- Press **[CAL]**.
- Select the proper calibration kit. If the connector type or cal kit name shown in the **[CAL KIT]** softkey label is not the same as the calibration kit to be used, refer to *Select Cal Kit Menu*.
- Press **[CALIBRATE MENU]** **[RESPONSE & ISOL'N]** **[RESPONSE]**.
- At port 1, connect either a short or a shielded open circuit.
- When the trace settles, press **[SHORT]** or **[OPEN]**, depending on the standard used. (If more than one standard is measured, only the data for the last device is retained.)
- The message "WAIT – MEASURING CAL STANDARD" is displayed while the response data is measured. The softkey label **[SHORT]** or **[OPEN]** is then underlined.
- Press **[DONE: RESPONSE]**. The error coefficients are computed and stored. The response and isolation menu is displayed.
- Connect the isolation standard to port 1. This is an impedance-matched load (usually 50 or 75 ohms).
- Press **[ISOL'N STD]**. The S_{11} isolation data is measured. The softkey label is underlined.
- Press **[DONE RESP ISOL'N CAL]**. The directivity error coefficients are computed and stored. The correction menu is displayed with **[CORRECTION ON]**. A corrected trace is displayed.
- This completes the response and isolation calibration for correction of frequency response and directivity errors for reflection measurements. Now the test device can be connected and measured.

It is recommended that calibration data be saved, either in internal volatile memory or on an external disk. Refer to Chapter 10, *Saving Instrument States*.

Response and Isolation Calibration for Transmission Measurements

The procedure described here effectively removes the frequency response and isolation errors for transmission measurements of devices with wide dynamic range, using the menus illustrated in Figure 5-15. To calibrate for a combined transmission and reflection measurement, perform the transmission calibration on one channel and the reflection calibration described above on the other channel.

This procedure uses an S-parameter test set. A similar procedure can be performed with a transmission/reflection test set, using the input ports menu instead of the S-parameters menu (see Chapter 4, *Response Function Block*).

- Press **[MEAS]** [*Trans: FWD S21 B/R*].
- Press **[CAL]**.
- Select the proper calibration kit. If the connector type or cal kit name shown in the **[CAL KIT]** softkey label is not the same as the calibration kit to be used, refer to *Select Cal Kit Menu*.
- Press **[CALIBRATE MENU]** **[RESPONSE & ISOL'N]** **[RESPONSE]**.
- Make a thru connection between port 1 and port 2 (connect together the points at which the test device will be connected).
- When the trace has settled, press **[THRU]**. S_{21} response data is measured. The softkey label **[THRU]** is underlined.
- Press **[DONE: RESPONSE]**.
- Connect impedance-matched loads to port 1 and port 2. Press **[ISOL'N STD]**. The S_{21} isolation data is measured. The softkey label is underlined.
- Press **[DONE RESP ISOL'N CAL]**. The S_{21} error coefficients are computed and stored. The correction menu is displayed with **[CORRECTION ON]**. Corrected S_{21} data is displayed and the notation "Cor" at the left of the screen indicates that correction is on for this channel.

A similar procedure is used to calibrate for measurement of S_{12} , using the *[Trans: REV S12 B/R]* softkey in the S-parameters menu.

It is recommended that calibration data be saved, either in internal volatile memory or on an external disk. Refer to Chapter 10, *Saving Instrument States*.

S_{11} 1-Port Calibration for Reflection Measurements

This procedure uses the S_{11} 1-port menu illustrated in Figure 5-16 to perform a complete vector error correction for reflection measurements of one-port devices or properly terminated two-port devices. This is a high-accuracy calibration that effectively removes the directivity, source match, and frequency response errors from the measured data. The calibration described here uses an S-parameter test set: a similar procedure can be performed with a transmission/reflection test set, using the input ports menu instead of the S-parameters menu (described in Chapter 4, *Response Function Block*).

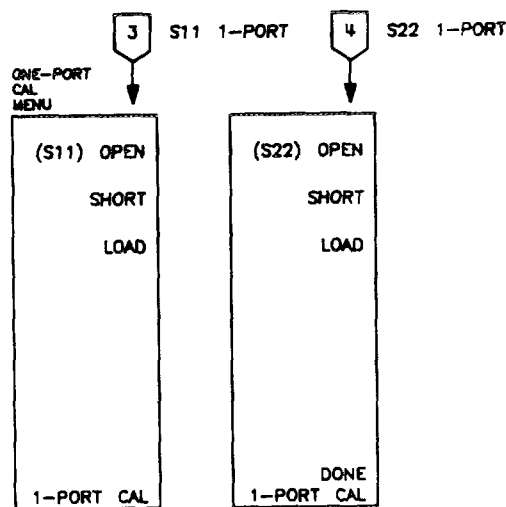

Figure 5-16. S_{11} and S_{22} 1-Port Cal Menus

- Press **[CAL]**.
- Select the proper calibration kit. If the connector type or cal kit name shown in the **[CAL KIT]** softkey label is not the same as the calibration kit to be used, refer to *Select Cal Kit Menu*.
- Press **[CALIBRATE MENU] [S11 1-PORT]**.
- Connect a shielded open circuit to port 1.
- When the trace settles, press (S₁₁) **[OPEN]**.
- The message "WAIT – MEASURING CAL STANDARD" is displayed while the open circuit data is measured. The softkey label **[OPEN]** is then underlined.
- Disconnect the open, and connect a short circuit to port 1.
- When the trace settles, press **[SHORT]**. The short circuit data is measured and the softkey label is underlined.
- Disconnect the short, and connect an impedance-matched load (usually 50 or 75 ohms) at port 1.
- When the trace settles, press **[LOAD]**. The load data is measured and the softkey label is underlined.
- Press **[DONE 1-PORT CAL]**. (If you press **[DONE]** without measuring all the required standards, the message "CAUTION: ADDITIONAL STANDARDS NEEDED" will be displayed.) The error coefficients are computed, and the correction menu is returned to the screen with **[CORRECTION ON]**. A corrected S_{11} trace is displayed, and the notation "Cor" appears at the left side of the screen.
- This completes the S_{11} 1-port calibration. The test device can now be connected and measured.

It is recommended that calibration data be saved, either in internal volatile memory or on an external disk. Refer to Chapter 10, *Saving Instrument States*.

S₂₂ 1-Port Calibration

This procedure performs a complete vector error correction for a reverse reflection measurement of a one-port device or a properly terminated two-port device. It is similar to the S₁₁ 1-port calibration except that S₂₂ is selected automatically.

This calibration is used only with an S-parameter test set. For S-parameter measurements in the reverse direction with a transmission/reflection test set use the S₁₁ 1-port or one-path 2-port calibration and reverse the device under test between measurement sweeps.

Full 2-Port Calibration for Reflection and Transmission Measurements

This procedure uses the menu sequence illustrated in Figure 5-17 to perform complete vector error correction for measurement of all four S-parameters. This is the most accurate calibration for measurements of two-port devices, and effectively removes all correctable systematic errors in both the forward and reverse directions.

An S-parameter test set is required for this calibration. The procedure automatically switches the test set to select the appropriate S-parameter at each step. A similar two-port procedure can be performed with a transmission/reflection test set using the one-path 2-port calibration.

To extend the life of the mechanical transfer switch in the HP 85046A/B or 85047A S-parameter Test Sets, switching occurs only once in a measurement sequence using full two-port error correction. On the first sweep all four S-parameters are measured. On subsequent sweeps, the assumption is made that the reverse parameters have not changed, and only the forward parameters are measured. It is possible to override this protection feature for applications where extreme accuracy is required or in cases where the data changes significantly. To perform an override, use **[MEASURE RESTART]** in the stimulus menu, or for repeated update of all four S-parameters set an appropriate number of groups using the **[NUMBER OF GROUPS]** softkey. These menus are described in Chapter 3.

Isolation calibration can be omitted for most measurements, except where wide dynamic range is a consideration. Refer to the explanation under **[CAL] Key**.

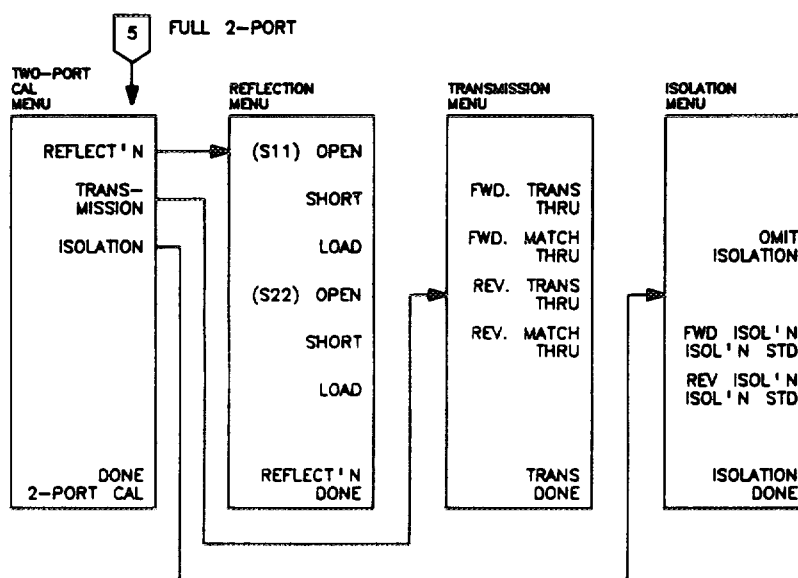

Figure 5-17. Full 2-Port Cal Menu

- Press **[CAL]**.
- Select the proper calibration kit. If the connector type or cal kit name shown in the **[CAL KIT]** softkey label is not the same as the calibration kit to be used, refer to *Select Cal Kit Menu*.
- Press **[CALIBRATE MENU] [FULL 2-PORT] [REFLECT'N]**.
- Connect a shielded open circuit to port 1.
- When the trace settles, press (S₁₁) **[OPEN]**. The open circuit data is measured, and the softkey label **[OPEN]** is underlined.
- Disconnect the open, and connect a short circuit to port 1.
- When the trace settles, press (S₁₁) **[SHORT]**. The short circuit data is measured and the softkey label **[SHORT]** is underlined.
- Disconnect the short, and connect an impedance-matched load (usually 50 or 75 ohms) at port 1.
- When the trace settles, press (S₁₁) **[LOAD]**. The load data is measured, and the softkey label **[LOAD]** is underlined.
- Repeat the open-short-load measurements described above, connecting the devices in turn to port 2 and using the (S₂₂) softkeys.
- Press **[REFLECT'N DONE]**. (If you press **[DONE]** without measuring all the required standards, the message "CAUTION: ADDITIONAL STANDARDS NEEDED" will be displayed.)
- The reflection calibration coefficients are computed and stored. The two-port cal menu is displayed, with the **[REFLECT'N]** softkey underlined.
- Press **[TRANSMISSION]**.
- Make a thru connection between port 1 and port 2 (connect together the points at which the test device will be connected).
- When the trace settles, press **[FWD. TRANS. THRU]**. S₂₁ frequency response is measured, and the softkey is underlined.
- Press **[FWD. MATCH THRU]**. S₁₁ load match is measured, and the softkey is underlined.
- Press **[REV. TRANS. THRU]**. S₁₂ frequency response is measured, and the softkey is underlined.
- Press **[REV. MATCH THRU]**. S₂₂ load match is measured, and the softkey is underlined.
- Press **[TRANS. DONE]**. The transmission coefficients are computed and stored. The two-port cal menu is displayed, with the **[TRANSMISSION]** softkey underlined.
- If correction for isolation is not required, press **[ISOLATION] [OMIT ISOLATION] [ISOLATION DONE]**.
- If correction for isolation is required, connect impedance-matched loads to port 1 and port 2.
- Press **[FWD ISOL'N ISOL'N STD]**. S₂₁ isolation is measured, and the softkey label is underlined.
- Press **[REV ISOL'N ISOL'N STD]**. S₁₂ isolation is measured, and the softkey label is underlined.
- Press **[ISOLATION DONE]**. The isolation error coefficients are stored. The two-port cal menu is displayed, with the **[ISOLATION]** softkey underlined.
- Press **[DONE 2-PORT CAL]**. The error coefficients are computed and stored. The correction menu is displayed with **[CORRECTION ON]**. A corrected trace is displayed, and the notation "C2" at the left of the screen indicates that two-port error correction is on.
- This completes the full two-port calibration procedure. Now the test device can be connected and measured.

It is recommended that calibration data be saved, either in internal volatile memory or on an external disk. Refer to Chapter 10, *Saving Instrument States*.

One-Path 2-Port Calibration for Reflection and Transmission Measurements

This procedure performs a two-port calibration without an S-parameter test set, using the series of menus illustrated in Figure 5-18. This is a highly accurate calibration for measurements of two-port devices, and effectively removes all correctable systematic errors in one direction only.

Isolation calibration can be omitted for most measurements, except where wide dynamic range is a consideration. Refer to the explanation under *[CAL] Key*.

For measurements of all four S-parameters, the device under test must be reversed between sweeps. The analyzer compatible calibration kits contain sets of phase-matched adapters that can be interchanged for measurements of non-insertable, non-reversible devices.

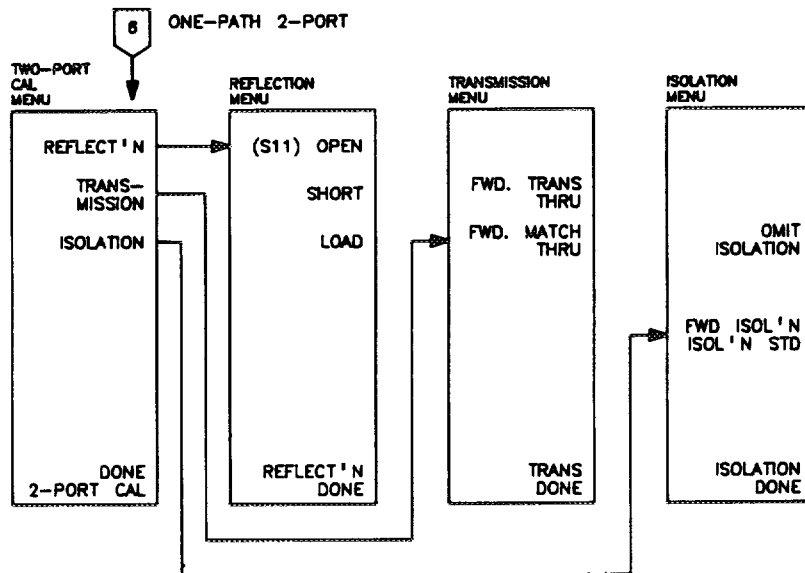

Figure 5-18. One-Path 2-Port Cal Menu

- Press **[CAL]**.
- Select the proper calibration kit. If the connector type or cal kit name shown in the **[CAL KIT]** softkey label is not the same as the calibration kit to be used, refer to *Select Cal Kit Menu*.
- Press **[CALIBRATE MENU] [ONE-PATH 2-PORT] [REFLECT 'N]**.
- Connect a shielded open circuit to the test port.
- When the trace settles, press **(S₁₁) [OPEN]**. The open circuit data is measured, and the softkey label **[OPEN]** is underlined.
- Disconnect the open, and connect a short circuit to the test port.
- When the trace settles, press **[SHORT]**. The short circuit data is measured and the softkey label **[SHORT]** is underlined.
- Disconnect the short, and connect an impedance-matched load (50 or 75 ohms) to the test port.
- When the trace settles, press **[LOAD]**. The load data is measured, and the softkey label **[LOAD]** is underlined.
- Press **[REFLECT 'N DONE]**. (If you press **[DONE]** without measuring all the required standards, the message "CAUTION: ADDITIONAL STANDARDS NEEDED" will be displayed.)

- The reflection calibration coefficients are computed and stored. The two-port cal menu is displayed, with the **[REFLECT'N]** softkey underlined.
- Make a thru connection between the test port and the return cable to the analyzer (connect together the points at which the test device will be connected). Press **[TRANSMISSION]**.
- When the trace settles, press **[FWD. TRANS. THRU]**. S_{21} frequency response is measured, and the softkey is underlined.
- Press **[FWD. MATCH THRU]**. S_{11} load match is measured, and the softkey is underlined.
- Press **[TRANS. DONE]**. The transmission coefficients are computed and stored. The two-port cal menu is displayed, with the **[TRANSMISSION]** softkey underlined.
- If correction for isolation is not required, press **[ISOLATION] [OMIT ISOLATION] [ISOLATION DONE]**.
- If correction for isolation is required, connect impedance-matched loads to the test port and the return port.
- Press **[FWD ISOL'N ISOL'N STD]**. S_{21} isolation is measured, and the softkey label is underlined.
- Press **[ISOLATION DONE]**. The isolation error coefficients are stored. The two-port cal menu is displayed, with the **[ISOLATION]** softkey underlined.
- Press **[DONE 2-PORT CAL]**. The error coefficients are computed and stored. The correction menu is displayed with **[CORRECTION ON]**. A corrected trace is displayed, and the notation "C2" at the left of the screen indicates that 2-port error correction is on.
- This completes the one-path 2-port calibration procedure. Now the test device can be connected and measured in the forward direction. When forward measurement is complete, disconnect the test device and manually reverse it, then press the softkey **[PRESS to CONTINUE]**, or trigger another sweep using the trigger menu (Chapter 3).

It is recommended that calibration data be saved, either in internal volatile memory or on an external disk. Refer to Chapter 10, *Saving Instrument States*.

POWER METER CALIBRATION

An HP-IB compatible power meter can monitor and correct RF source power to achieve leveled power at the test port. To correct the power going to the DUT, power meter calibration samples the power at each measurement point across the frequency band of interest. It then constructs a correction data table which the instrument uses to correct the power output of the internal source. The correction table may be saved in an instrument state register with the **[SAVE]** key.

The correction table may be updated on each sweep (in a leveling application) or during an initial single sweep. In the sample-and-sweep mode the power meter is not needed for subsequent sweeps. The correction table may be read or modified through HP-IB. Refer to the *HP-IB Quick Reference Guide* for details.

NOTE: Instructions for using power meter calibration are provided later in this chapter. Refer to the chapter table of contents for the page number.

Primary Applications

- When using a test system with significant frequency response errors. For example, a coupler with significant roll-off, or a long cable with a significant amount of loss.
- When measuring devices that are very sensitive to actual input power for proper operation.

- To allow measurements where power meter accuracy is required to meet a specification.

Calibrated Power Level

By setting the analyzer calibrated power to the desired value at the power meter, this power level will be maintained at that port during the entire sweep. It is recommended that the operator first set the source power such that the power at the DUT is approximately correct. This reduces residual power errors when only one number of readings is taken (see **[NUMBER OF READINGS]** softkey description). When power meter calibration is on, the annotation "PC" is displayed. This indicates that the source power is being changed during the sweep. Calibrated power level becomes the active entry if any of the following softkeys are pressed:

[PWRMTR CAL OFF] **[EACH SWEEP]** **[ONE SWEEP]**

Regardless of the measurement application, the analyzer's source can only supply power from +20 to -5 dBm. If power outside this range is requested, the annotation will change to "PC?".

Compatible Sweep Types

Power meter calibration may be used in linear, log, list, CW, and power sweep modes. In power sweep, the power at each point is the true power at the power meter, not the power at the analyzer's source output.

Loss of Power Meter Calibration Data

Turning Power Off. Turning off the instrument erases the power meter calibration table and all instrument save/recall registers.

Changing Sweep Type. If the sweep type is changed (linear, log, list, CW, power) while power meter calibration is on, the calibration data will be lost. However, calibration data is retained if you change the sweep type while power meter calibration is off.

Changing Frequency. Power meter calibration data will also be lost if the frequency is changed in log or list mode, but it is retained in linear sweep mode.

Pressing [PRESET]. Presetting the instrument will erase power meter calibration data. If the instrument state has been saved in a register using the **[SAVE]** key, the user may recall the instrument state and the data will be restored. Saving the instrument state will not protect the data if the instrument is turned off.

Interpolation in Power Meter Calibration

If the frequency is changed in linear sweep, or the start/stop power is changed in power sweep, then the calibration data is interpolated for the new range.

If calibration power is changed in any of the sweep types, the data array is increased or decreased to reflect the new power level. Some accuracy is lost when this occurs.

Power Meter Calibration Above 3 GHz

When an HP 85047A 6 GHz test set is used with an option 006 analyzer, a doubler in the test set provides 3 MHz to 6 GHz frequency range. This doubler mode requires a constant, high input power. In the 6 GHz mode, the default power output of the internal source is +20 dBm. The test set is designed to operate with this input level in the 3 MHz to 6 GHz range. If power meter calibration forces the power level to change more than a few dB, the performance of the RF signal may degrade. Refer to Chapter 14.

POWER METER CALIBRATION MODES OF OPERATION

Continuous Correction [EACH SWEEP]

Refer to Figure 5-19. A power splitter or directional coupler samples the actual power going to the DUT and is measured by the power meter. This sampling occurs once at each measurement point. The operator may ask for more than one sample/correction iteration at each frequency point. This is explained in the [NUMBER OF READINGS] softkey description. Continuous correction slows the sweep speed considerably, especially when low power levels are being measured by the power meter. It may take up to 10 seconds per point if the power level is less than -20 dBm. For faster operation, the sample-and-sweep mode may be used. If a directional coupler is used, the attenuation of the coupled arm with respect to the through arm must be entered using the [POWER LOSS] softkey.

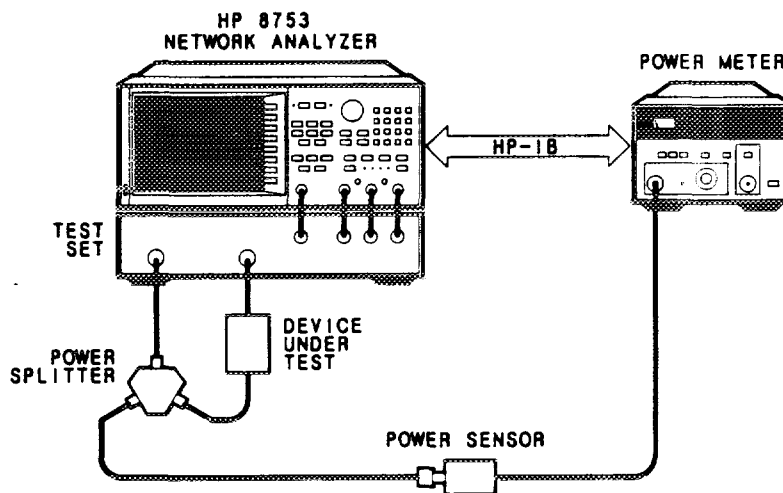

Figure 5-19. Typical Test Setup for Continuous Correction

Sample-and-Sweep Correction [ONE SWEEP]

Refer to Figure 5-20. You may use a power splitter or directional coupler, or simply remove the DUT and measure the power at that point in the measurement setup. The sample-and-sweep mode allows you to measure the power characteristics across the frequency band of interest with a single sweep. The speed of the calibration will be slow while power meter readings are taken (see the *Typical Speed and Accuracy* table shown on a following page). However, once the sample sweep is finished, subsequent sweeps are power-corrected using the data table, and sweep speed increases significantly. Once the initial sweep is taken, sample-and-sweep correction is much faster than continuous sweep correction.

If the calibrated power level is changed after the initial measurement sweep is done, the entire correction table is increased or decreased by that amount and the annotation "PCo" appears on the CRT. The resulting power will no longer be as accurate as the original calibration.

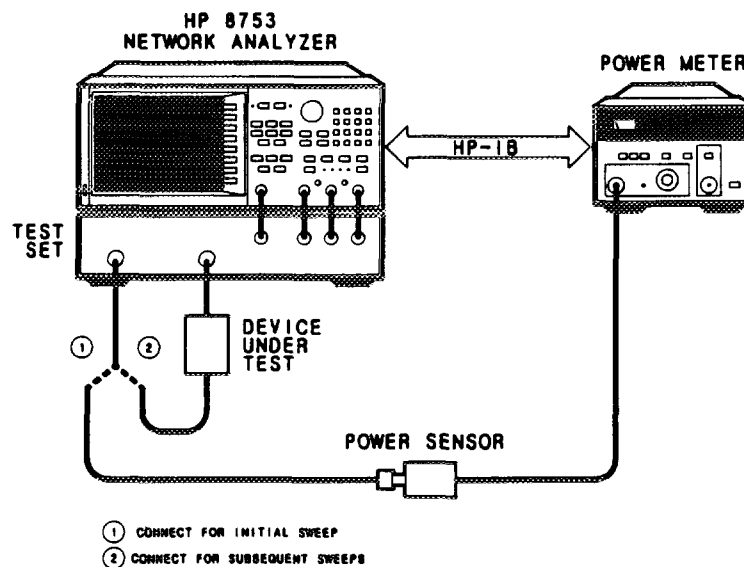

Figure 5-20. Typical Test Setup for Sample-and-Sweep Correction

Other Details

Power Meter HP-IB Address. Before using power meter calibration, you must select the power meter address using the [LOCAL] [SET ADDRESSES] keys and address menu. Then select the type of power meter in use with the [P MTR/HPIB] softkey.

System Controller Mode. The analyzer must be set to the system controller mode using the [LOCAL] [SYSTEM CONTROLLER] keys.

Power Loss Correction List. If a directional coupler or power splitter is used to sample the RF power output of the analyzer, the RF signal going to the power meter may be different than that going to the DUT. A directional coupler will attenuate by its specified coupling factor. The difference in attenuation between the through arm and the coupled arm (coupling factor) must be entered using the loss/sensor list menu. Non-linearities in either the directional coupler or power splitter may be corrected in the same way.

Power loss information is entered in much the same way as limit line parameters. Up to 12 segments may be entered, each with a different attenuation value.

Power Sensor Calibration Factor List. Two power sensor calibration data lists can be created in the analyzer. The second list is primarily for use with an analyzer option 006 (6 GHz) system. Since no single power sensor covers the entire frequency range of 300 kHz to 6 GHz, the calibration data for two different power sensors must be available. Refer to the loss/sensor list menu explained later in this chapter.

Speed and Accuracy

The speed and accuracy of a power meter calibration vary depending on the test setup and the measurement parameters. When the number of readings = 1, accuracy is improved if the operator sets the source power such that it is approximately correct at the measurement port. Power meter calibration should then be turned on.

Table 5-4 shows typical sweep speed and power accuracy. The times given apply only to the test setup described, for continuous calibration or for the first sweep of sample-and-sweep correction. Subsequent sweeps in the sample-and-sweep mode will be much faster than the values shown in Table 5-4. Several power levels and numbers of readings are shown.

The typical values given in the table were derived under the following conditions:

Test Setup: The test setup used the following instruments:

- Instrument/Test Set: HP 8753 with HP 85046A.
- Power Meter/Power Sensor: HP 436A with HP 8482A.

Stimulus Parameters: The time required to perform a power meter calibration is greatly affected by the source power and number of points tested. The parameters used to derive the typical values in Table 5-4 are as follows:

- Number of Points: 51.
- Source Power: +10 dBm.
- Attenuator Port 1: 0 dB.

Sweep time is linearly proportional to the number of points measured. For example, a sweep taking 33 seconds at 51 points will take approximately 66 seconds if 101 points are measured.

Table 5-4. Typical Speed and Accuracy

Power Desired at Test Port (dBm)	Number of Readings	Sweep Time (seconds) ¹	Typical Accuracy (dB)
+5	1	33	±0.7
	2	64	±0.2
	3	95	±0.1
-15	1	48	±0.7
	2	92	±0.2
	3	123	±0.1
-30 ²	1	194	±0.7
	2	360	±0.2
	3	447	±0.1

1 Sweep speed applies to every sweep in continuous correction mode, and to the first sweep in sample-and-sweep mode. Subsequent sweeps in sample-and-sweep mode will be much faster.

2 The port 1 attenuator was set at 20 dB, allowing the analyzer's source to deliver -30 dBm at the test port.

Notes on Accuracy. The accuracy values in Table 5-4 were derived by combining the accuracy of the power meter and linearity of the analyzer's internal source, as well as the mismatch uncertainty associated with the test set and the power sensor.

Power meter calibration measures the source power output (at the measurement port) at a single stimulus point, and compares it to the calibrated power selected by the operator. If the two values are different, power meter calibration changes the source output power by the difference. This process is repeated at every stimulus point. The accuracy of the result depends on the amount of correction required. If the selected number of readings = 1, the final measurement accuracy is significantly affected by a large power change. However, if the selected number of readings is >1, the power change on the second or third reading is much smaller: thus accuracy is much better.

Two methods can be used to perform power meter calibration. If the selected number of readings is >1, then it makes little difference which method is used. However, if number of readings = 1, then the first method provides better accuracy. The values in Table 5-4 were derived using the second (worst case) method.

- **Set source power approximately correct at the measurement port, then activate power meter calibration.** This method can significantly increase the accuracy of the measurement when the selected number of readings = 1. Smaller accuracy improvements occur with a higher number of readings. Remember that mismatch errors affect accuracy as well.
- **Activate power meter calibration independent of the source's current power setting.** There may be a large difference between the current power level and the desired calibrated power level. Power meter calibration will automatically adjust the power at the measurement port to match the desired calibrated power level. However, a large change in power affects accuracy, especially if the number of readings = 1. The accuracy values given in Table 5-4 were calculated with an initial power setting of +10 dB. The power range of the analyzer's source is +20 to -5 dBm, so the worst-case power correction is 25 dB.

USING POWER METER CALIBRATION

To use power meter calibration you must perform the following steps:

Before Turning Power Meter Calibration On

- Enter the HP-IB address of the power meter into the analyzer. Press [LOCAL] [SET ADDRESSES] [P MTR/HPIB] [#] [#] [x1], where ## is the two digit HP-IB address currently in use by the power meter.
- Press [POWER MTR: [43X]] until the softkey label shows the power meter in use. Currently three power meters are supported: HP 436A, 437B, and 438A.
- Set the analyzer to system controller mode. Press [LOCAL] [SYSTEM CONTROLLER].
- Enter the power sensor calibration data. Press [CAL] [PWR MTR [43X]] [LOSS/SENSR LISTS] [CAL FACTOR SENSOR A] and enter the power sensor calibration factors for each desired frequency segment. Details on the segment edit menus are provided later in this chapter.

For the HP 8753 option 006 (6 GHz operation), enter the power meter calibration factors for the higher frequency power sensor. Select [CAL FACTOR SENSOR B] and enter the calibration factors for each desired segment.

- Press [CAL] [PWR METER [43X]] to enter the main power meter calibration menu.

Compensating for Power Splitter/Directional Coupler Attenuation Non-Linearities [POWER LOSS]

Power loss data can be entered at up to 12 segments. The correction values between segments are interpolated by the analyzer.

Directional Couplers. If a directional coupler is used, the power loss through the coupled arm should be entered for at least one frequency point with the [POWER LOSS] softkey. You can enter the loss information in a single segment, and the analyzer will assume that the value applies to the entire frequency range of the instrument. Or actual measured power loss values may be input at several frequencies using multiple segments, enhancing power accuracy.

Power Splitters. Power accuracy can be improved when using a power splitter to sample the RF output. Using the power loss feature, the user can compensate for tracking errors.

- Press [LOSS/SENSR LISTS] [POWER LOSS]. Enter the attenuation of the power splitter or directional coupler at as many frequency segments as needed, depending on the required accuracy. The power loss submenus are explained later in this chapter. When finished, press [DONE] to get back to the power loss menu and [RETURN] to get back to the power meter calibration menu.
- Press [POWER LOSS on OFF] to turn on power loss compensation.

Using Continuous Sample Mode

The [EACH SWEEP] function continuously checks power at every point in each sweep. The power meter must remain connected as shown in Figure 5-19.

- Cal power becomes the active function. Enter the desired test port power level (the power level you wish to maintain at the input to the DUT).

- Use a power splitter or directional coupler to tap off RF power going to the DUT. Compensate for power loss if using a directional coupler.
- For more than one power measurement at each frequency point in the stimulus range, press **[NUMBER OF READINGS] [n] [x1]**, where n = the number of desired iterations. (Note that this will substantially increase the power meter calibration time.)
- Press **[EACH SWEEP]** to turn on power meter calibration.

Using Sample-and-Sweep Mode

When the **[ONE SWEEP]** softkey is pressed, the instrument corrects the output power using the power meter calibration data table. Pressing **[TAKE CAL SWEEP]** causes the initial measurement sweep to occur, which updates the data table. After that, remove the power meter sensor and connect the DUT. Subsequent sweeps will use the data table to correct the output power level at each point. A typical setup is shown in Figure 5-20.

- Cal power becomes the active function. Enter the desired test port power level (the power level you wish to maintain at the input to the DUT).
- Measure the power at the DUT input node directly.
- For more than one power measurement at each frequency point in the stimulus range, press **[NUMBER OF READINGS] [#] [x1]**. (Note that this will substantially increase the power meter calibration time.)
- Press **[ONE SWEEP] [TAKE CAL SWEEP]**. The actual power at each frequency point will be measured with the initial sweep. During this sweep, sweep speed will slow significantly.
- Remove the power meter sensor and connect the DUT.

Calibration Data Table

Valid calibration data will be in the power correction table if one of the following has occurred:

- Either **[TAKE CAL SWEEP]** or **[EACH SWEEP]** has been pressed.
- Calibration data has been placed in the table via HP-IB.

Power Meter Calibration Menus

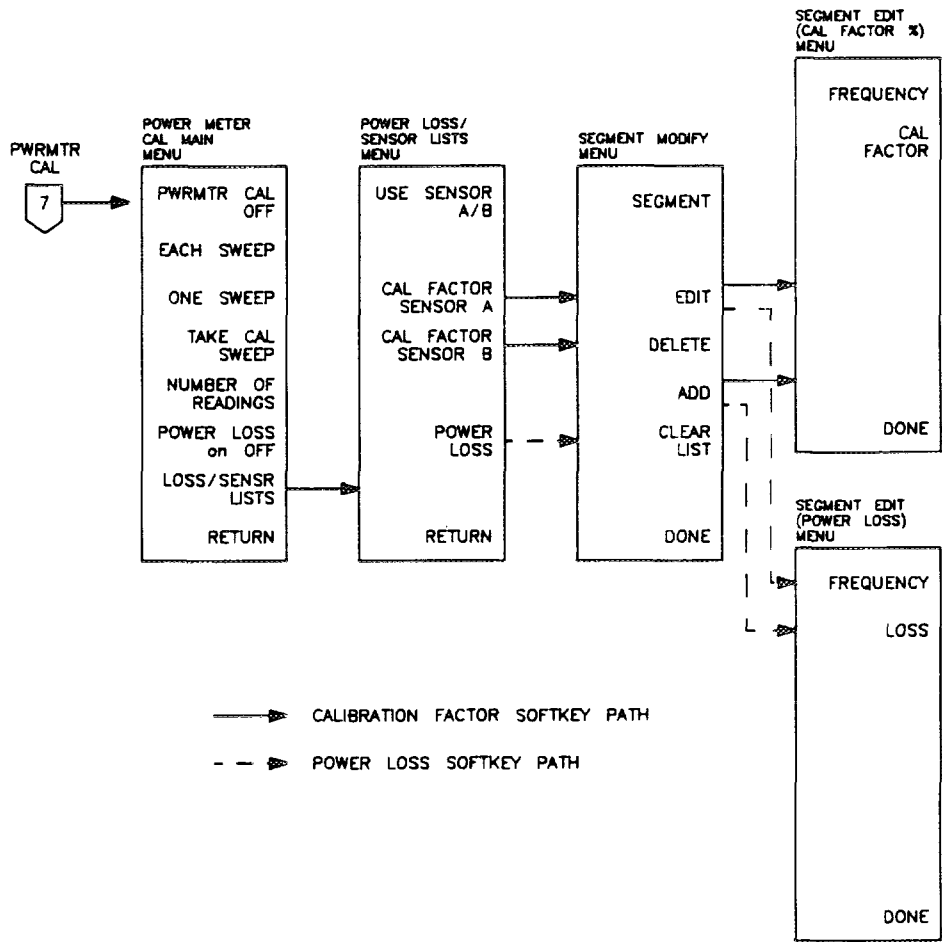

Figure 5-21. Softkey Menus Accessed from the [PWRMTR CAL] Softkey.

Power Meter Calibration Main Menu

Refer to Figure 5-21.

[PWRMTR CAL OFF] (PWMCOFF) turns off power meter calibration.

[EACH SWEEP] (PWMCEACS). Power meter calibration occurs on each sweep. Each measurement point is measured by the power meter, which provides the analyzer with the actual power reading. The analyzer corrects the power level at that point. The number of measurement/correction iterations performed on each point is determined by the **[NUMBER OF READINGS]** softkey. This measurement mode sweeps slowly, especially when the measured power is small. Small power levels require more time for the power meter to settle. The power meter correction table in memory is updated after each sweep. This table can be read or changed via HP-IB.

[ONE SWEEP] (PWMCONES). This mode does not measure each sweep, but corrects each point with the data currently in the power meter correction table. The **[TAKE CAL SWEEP]** softkey may be used to measure the power level at each point during a single sweep, and place correction data in the table. If the **[EACH SWEEP]** function was used earlier, correction data already exists in the table.

As with the **[EACH SWEEP]** softkey, the number of measurement iterations at each point can be selected using the **[NUMBER OF READINGS]** softkey.

[TAKE CAL SWEEP] (TAKCS) Each data point is measured during the initial sweep and the correction data is placed in the power meter correction table. This provides data usable in the **[ONE SWEEP]** mode.

[NUMBER OF READINGS] (NUMR) determines the number of measurement/correction iterations performed on each point. This feature helps eliminate residual power errors after the initial correction. The amount of residual error is directly proportional to the magnitude of the initial correction. The user should initially set the source power so that it is approximately correct when it arrives at the DUT. If power uncertainty at the DUT is expected to be greater than a few dB, it is recommended that the number of readings be greater than 1.

[PWR LOSS on OFF] (PWRLOSSON, PWRLOSSOFF) turns on or off power loss correction. Power loss correction should be used when the power output is measured by a directional coupler. Enter the power loss caused by the coupled arm with the **[LOSS/SENSR LISTS]** softkey submenus described below.

[LOSS/SENSR LISTS] presents the power loss/sensor lists menu. This menu performs two functions:

- Corrects coupled-arm power loss when a directional coupler is used to sample the RF output.
- Allows calibration factor data to be entered for one or two power sensors.

Each function provides up to 12 separate frequency points, called segments, at which the user may enter a different power loss or calibration factor. The instrument interpolates between the selected points. Two power sensor lists are provided because no single power sensor can cover the frequency range possible with an HP 8753 option 006 (6 GHz operation)/ HP 85047A test set system.

[RETURN] goes back to the main calibration menu.

Power Loss/Sensor Lists Menu

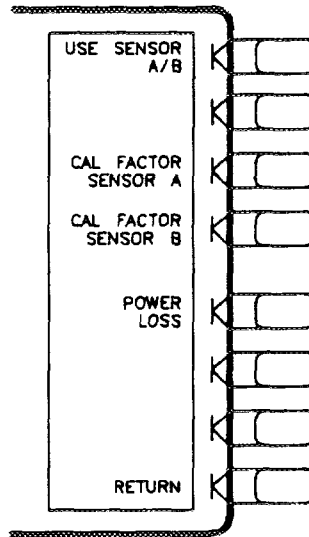

Figure 5-22. Power Loss/Sensor Lists Menu

[USE SENSOR A / B] (USESENSA, USESENSB) selects the A or B power sensor calibration factor list for use in power meter calibration measurements.

[CAL FACTOR SENSOR A] (CALFSENA) brings up the segment modify menu and segment edit (calibration factor %) menu explained on the following pages. The calibration factor data entered in this menu will be stored for power sensor A.

[CAL FACTOR SENSOR B] (CALFSENB) brings up the segment modify menu and segment edit (calibration factor %) menu explained on the following pages. The calibration factor data entered in this menu will be stored for power sensor B.

[POWER LOSS] (POWLLIST) brings up the segment modify menu and segment edit (power loss) menu explained in the following pages. This softkey is intended for use when the power output is being sampled by a directional coupler or power splitter. In the case of the directional coupler, enter the power loss caused by the coupled arm. Refer to *Power Loss Feature* on a previous page.

This feature may be used to compensate for attenuation non-linearities in either a directional coupler or a power splitter. Up to 12 segments may be entered, each with a different frequency and power loss value.

Segment Modify Menu

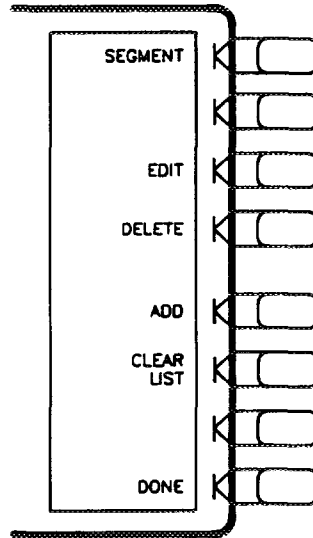

Figure 5-23. Segment Modify Menu

This menu performs two tasks:

- It allows the user to enter power sensor calibration data for one or two power sensors.
- It enters power loss data (refer to the **[POWER LOSS]** softkey description).

For either power loss or power sensor calibration data, the user may select from 1 to 12 frequency segments. Multiple segments do not have to be entered in any particular order: the analyzer automatically sorts them and lists them on the CRT in increasing order of frequency.

You may wish to use only one segment. In this case, the analyzer assumes that the single value is valid over the entire frequency range of the calibration.

For high accuracy, actual measured power loss and/or power sensor calibration data may be entered for as many as 12 separate frequency points (segments). The frequencies between the points are interpolated by the instrument.

Using the Segment Modify Menu. Before any segment information is entered in the list, the word "EMPTY" is displayed on the CRT. You can create the first segment by pressing either **[EDIT]** or **[ADD]**. Enter the desired frequency and cal factor/power loss data when the appropriate segment edit menu appears.

For example, in the segment edit (power loss) menu, press: **[FREQUENCY] [1] [G/n] [LOSS] [6] [x1]** to add a segment to the power loss list. Now press **[DONE]**.

Once an entry has been made, use the **[ADD]** softkey to enter additional segments. The default segment number when **[ADD]** is pressed is the next consecutive whole number above the last segment number. Follow the above instructions to define the next segment in the list.

To delete an entry in the list, press **[SEGMENT]** and use the entry block controls to select the desired segment. Press **[DELETE]**.

To erase all entries, press the **[CLEAR LIST]** softkey.

[SEGMENT] specifies which segment in the list is to be modified. A maximum of two segments is displayed at one time, and the list can be scrolled up or down to show other segment entries. Use the entry block controls to move the pointer > to the desired segment number. The selected segment can now be edited or deleted.

[EDIT] (SEDIn, where "n" is the segment number). This softkey brings up the appropriate segment edit menu described in the following pages. The edit command modifies the segment previously selected with the **[SEGMENT]** softkey.

[DELETE] (SDEL) Deletes the segment previously selected with the **[SEGMENT]** softkey.

[ADD] (SADD) adds another segment to the bottom of the list and presents the appropriate segment edit menu described in the following pages.

[CLEAR LIST] (CLEL) deletes all segments in the list.

[DONE] (EDITDONE) goes back to the power loss/sensor list menu.

Segment Edit (Calibration Factor %) Menu

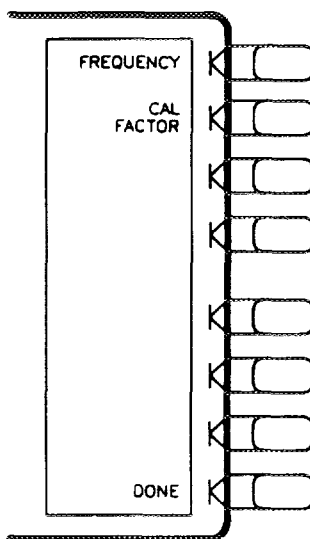

Figure 5-24. Segment Edit (Calibration Factor %) Menu

This menu defines the frequency and calibration factor % for the segment being added or edited.

[FREQUENCY] (CALFFREQ) accepts a frequency value for the segment.

[CAL FACTOR] (CALFCALF) accepts a calibration factor % for the segment.

[DONE] (SDON) goes back to the segment modify menu and sorts the list according to increasing frequency.

Segment Edit (Power Loss) Menu

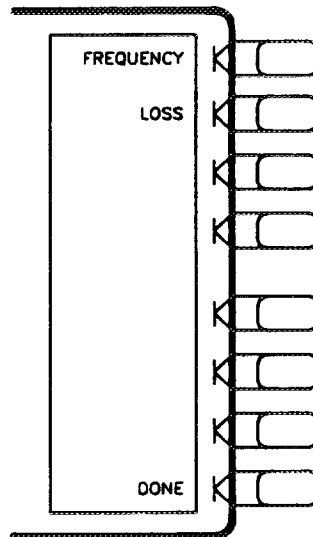

Figure 5-25. Segment Edit (Power Loss) Menu

This menu defines the frequency and power loss for the segment being added or edited.

[FREQUENCY] (POWLFREQ) accepts a frequency value for the segment.

[LOSS] (POWLLOSS) accepts a power loss value for the segment. This value, for example, could be the difference (in dB) between the coupled arm and through arm of a directional coupler.

[DONE] (SDON) goes back to the segment modify menu and sorts the list according to increasing frequency.

MODIFYING CALIBRATION KITS

NOTE: Hewlett-Packard strongly recommends that you read application note 8510-5A before attempting to view or modify calibration standard definitions. The part number of this application note is 5956-4352. Although the application note is written for the HP 8510 family of network analyzers, it also applies to the HP 8753. This portion of the calibration chapter provides a summary of the information in the application note, as well as HP 8753 menu-specific information.

For most applications, use the default cal kit models provided in the select cal kit menu described earlier in this chapter. Modifying calibration kits is necessary only if unusual standards are used or the very highest accuracy is required. Unless a cal kit model is provided with the calibration devices used, a solid understanding of error correction and the system error model are absolutely essential to making modifications. Read the introductory part of this chapter for more information, and refer to the Appendix to Chapter 5 and to *System Performance* in the *General Information and Specifications* section.

NOTE: Numerical data for most Hewlett-Packard calibration kits is provided in the calibration kit manuals.

During measurement calibration, the analyzer measures actual, well-defined standards and mathematically compares the results with ideal "models" of those standards. The differences are separated into error terms which are later removed during error correction. Most of the differences are due to systematic errors – repeatable errors introduced by the analyzer, test set, and cables – which are correctable. However, differences between the model for a standard and the actual performance of the standard reduce the system's ability to remove systematic errors, and thus degrade error-corrected accuracy. Therefore, in addition to the default cal kit models, a "user kit" is provided that can be modified to an alternate calibration standards model.

Several situations exist that may require a user-defined cal kit:

- A calibration is required for a connector interface different from the four default cal kits. (Examples: SMA, TNC, or waveguide.)
- A calibration with standards (or combinations of standards) that are different from the default cal kits is required. (Example: Using three offset shorts instead of open, short, and load to perform a 1-port calibration.)
- The built-in standard models for default cal kits can be improved or refined. Remember that the more closely the model describes the actual performance of the standard, the better the calibration. (Example: The 7 mm load is determined to be 50.4 ohms instead of 50.0 ohms.)
- Unused standards for a given cal type can be eliminated from the default set, to eliminate possible confusion during calibration. (Example: A certain application requires calibrating a male test port. The standards used to calibrate a female test port can be eliminated from the set, and will not be displayed during calibration.)

Definitions

The following are definitions of terms:

- A "standard" is a specific, well-defined, physical device used to determine systematic errors.
- A standard "type" is one of five basic types that define the form or structure of the model to be used with that standard (e.g. short or load).
- Standard "coefficients" are numerical characteristics of the standards used in the model selected.
- A standard "class" is a grouping of one or more standards that determines which standards are used in a particular calibration procedure.

Procedure

The following steps are used to modify or define a user kit:

1. To modify a cal kit, first select the predefined kit to be modified. This is not necessary for defining a new cal kit.
2. Define the standards. For each standard, define which "type" of standard it is and its electrical characteristics.
3. Specify the class where the standard is to be assigned.
4. Store the modified cal kit.

Following the descriptions of the menus for modifying calibration kits, a procedure is provided that enters the HP 85033C 3.5 mm calibration kit values as a "user kit."

Modify Cal Kit Menu

This menu is accessed from the [CAL] key (refer to Figure 5-8). This leads in turn to additional series of menus associated with modifying cal kits.

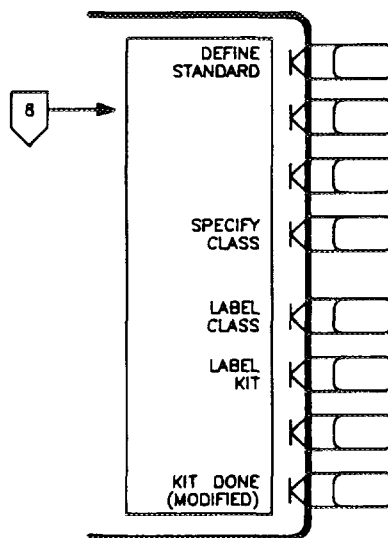

Figure 5-26. Modify Cal Kit Menu

[DEFINE STANDARD] (DEFS) makes the standard number the active function, and brings up the define standard menus. The standard number (1 to 8) is an arbitrary reference number used to reference standards while specifying a class. The standard numbers for the predefined calibration kits are as follows:

- | | |
|------------------|----------------|
| 1 short | 5 sliding load |
| 2 open | 6 lowband load |
| 3 broadband load | 7 short |
| 4 thru | 8 open |

[SPECIFY CLASS] leads to the specify class menu. After the standards are modified, use this key to specify a class to consist of certain standards.

[LABEL CLASS] leads to the label class menu, to give the class a meaningful label for future reference.

[LABEL KIT] (LABEK) leads to a menu for constructing a label for the user-modified cal kit. If a label is supplied, it will appear as one of the five softkey choices in the select cal kit menu. The approach is similar to defining a display title, except that the kit label is limited to ten characters. Refer to **[DISPLAY] Key, Title Menu** in Chapter 4 for details.

[KIT DONE] (KITD) terminates the cal kit modification process, after all standards are defined and all classes are specified. Be sure to save the kit with the **[SAVE USER KIT]** softkey, if it is to be used later.

Define Standard Menus

Standard definition is the process of mathematically modeling the electrical characteristics (delay, attenuation, and impedance) of each calibration standard. These electrical characteristics (coefficients) can be mathematically derived from the physical dimensions and material of each calibration standard, or from its actual measured response. The parameters of the standards can be listed in *Standards Definitions*, Table 5-5. The menus illustrated in Figure 5-27 are used to specify the type and characteristics for each user-defined standard.

Table 5-5. Standard Definitions

STANDARD		C0 x10 ⁻¹⁹ F	C1 x10 ⁻²⁷ F/Hz	C2 x10 ⁻³⁶ F/Hz	C3 x10 ⁻⁴⁶ F/Hz	FIXED OR SLIDING	OFFSET			FREQUENCY (GHz)		COAX or WAVEGUIDE	STANDARD LABEL
NO.	TYPE						DELAY ps	LOSS MΩ/s	Z ₀ Ω	MINIMUM	MAXIMUM		
1													
2													
3													
4													
5													
6													
7													
8													

Each standard must be identified as one of five "types": open, short, load, delay/thru, or arbitrary impedance.

After a standard number is entered, selection of the standard type will present one of five menus for entering the electrical characteristics (model coefficients) corresponding to that standard type. These menus are tailored to the current type, so that only characteristics applicable to the standard type can be modified.

Any standard type can be further defined with offsets in delay, loss, and standard impedance; assigned minimum or maximum frequencies over which the standard applies; and defined as coax or waveguide. Press the **[SPECIFY OFFSET]** key, and refer to the specify offset menu.

A distinct label can be defined and assigned to each standard, so that the analyzer can prompt the user with explicit standard labels during calibration (e.g. "SHORT"). Press the **[LABEL STD]** softkey. The function is similar to defining a display title, except that the label is limited to ten characters. Refer to **[DISPLAY] Key, Title Menu** in Chapter 4 for details.

After each standard is defined, including offsets, press **[STD DONE (DEFINED)]** to terminate the standard definition.

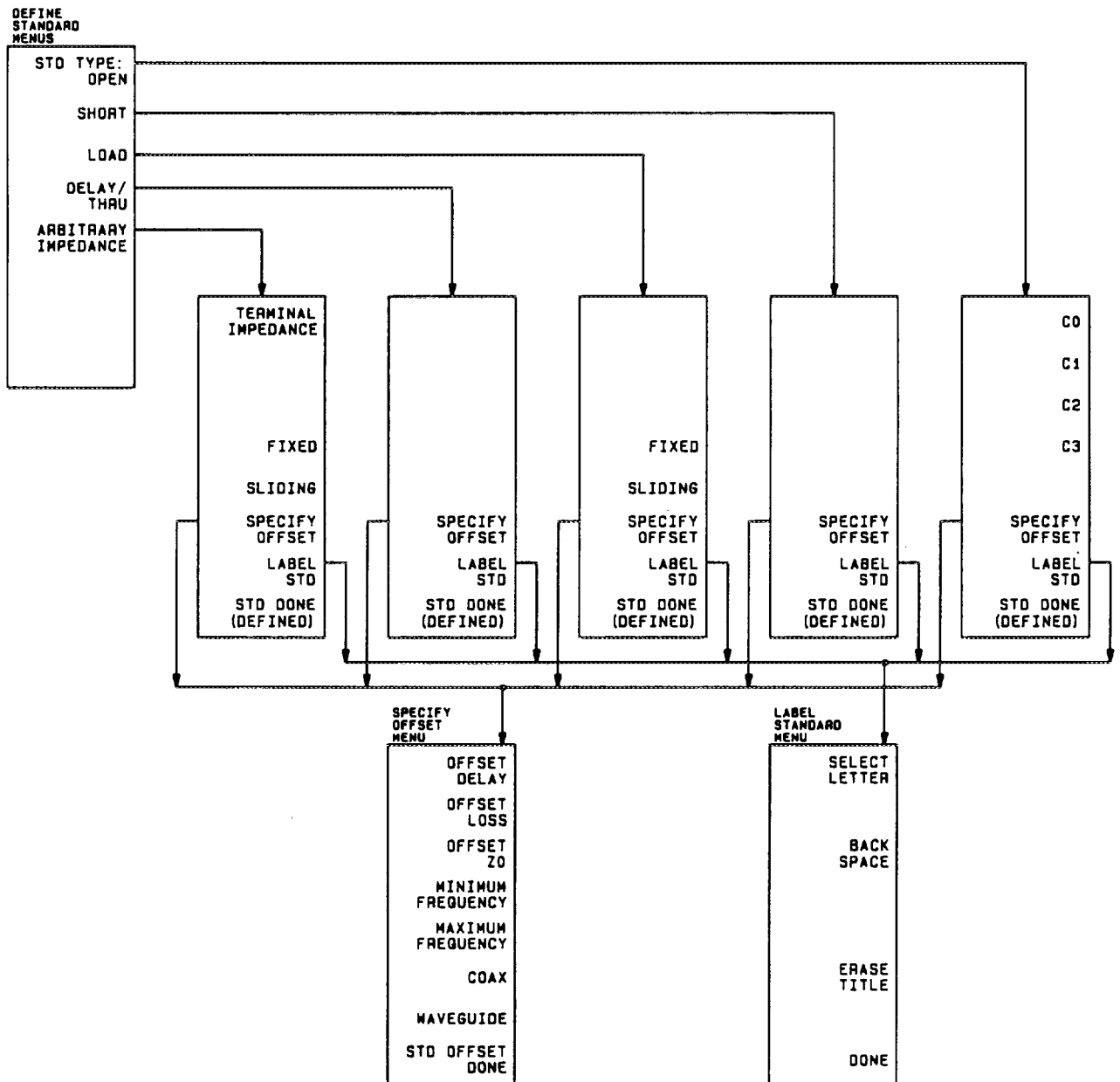

Figure 5-27. Define Standard Menus

[OPEN] (STDTOPEN) defines the standard type as an open, used for calibrating reflection measurements. Opens are assigned a terminal impedance of infinite ohms, but delay and loss offsets may still be added. Pressing this key also brings up a menu for defining the open, including its capacitance.

As a reflection standard, an open termination offers the advantage of broadband frequency coverage. At microwave frequencies, however, an open rarely has perfect reflection characteristics because fringing (capacitance) effects cause phase shift that varies with frequency. This can be observed in measuring an open termination after calibration, when an arc in the lower right circumference of the Smith chart indicates capacitive reactance. These effects are impossible to eliminate, but the calibration kit models include the open termination capacitance at all frequencies for compatible calibration kits. The capacitance model is a cubic polynomial, as a function of frequency, where the polynomial coefficients are user-definable. The capacitance model equation is:

$$C = (C0) + (C1 \cdot F) + (C2 \cdot F^2) + (C3 \cdot F^3)$$

where F is the measurement frequency.

The terms in the equation are defined with the specify open menu as follows:

[C0] (C0) is used to enter the C0 term, which is the constant term of the cubic polynomial and is scaled by 10^{-15} Farads.

[C1] (C1) is used to enter the C1 term, expressed in F/Hz (Farads/Hz) and scaled by 10^{-27} .

[C2] (C2) is used to enter the C2 term, expressed in F/Hz² and scaled by 10^{-36} .

[C3] (C3) is used to enter the C3 term, expressed in F/Hz³ and scaled by 10^{-45} .

[SHORT] (STDTSHOR) defines the standard type as a short, for calibrating reflection measurements. Shorts are assigned a terminal impedance of 0 ohms, but delay and loss offsets may still be added.

[LOAD] (STDTLOAD) defines the standard type as a load (termination). Loads are assigned a terminal impedance equal to the system characteristic impedance Z_0 , but delay and loss offsets may still be added. If the load impedance is not Z_0 , use the arbitrary impedance standard definition.

[FIXED] (FIXE) defines the load as a fixed (not sliding) load.

[SLIDING] (SLIL) defines the load as a sliding load. When such a load is measured during calibration, the analyzer will prompt for several load positions, and calculate the ideal load value from it.

[DELAY/THRU] (STDTDELA) defines the standard type as a transmission line of specified length, for calibrating transmission measurements.

[ARBITRARY IMPEDANCE] (STDTARBI) defines the standard type to be a load, but with an arbitrary impedance (different from system Z_0).

[TERMINAL IMPEDANCE] (TERI) is used to specify the (arbitrary) impedance of the standard, in ohms.

[FIXED] (FIXE) defines the load as a fixed (not sliding) load.

[SLIDING] (SLIL) defines the load as a sliding load. When such a load is measured during calibration, the analyzer will prompt for several load positions, and calculate the ideal load value from it.

Specify Offset Menu

The specify offset menu allows additional specifications for a user-defined standard. Features specified in this menu are common to all five types of standards.

Offsets may be specified with any standard type. This means defining a uniform length of transmission line to exist between the standard being defined and the actual measurement plane. (Example: a waveguide short circuit terminator, offset by a short length of waveguide.) For reflection standards, the offset is assumed to be between the measurement plane and the standard (one-way only). For transmission standards, the offset is assumed to exist between the two reference planes (in effect, the offset is the thru). Three characteristics of the offset can be defined: its delay (length), loss, and impedance.

In addition, the frequency range over which a particular standard is valid can be defined with a minimum and maximum frequency. This is particularly important for a waveguide standard, since its behavior changes rapidly beyond its cutoff frequency. Note that several band-limited standards can together be defined as the same "class" (see specify class menu). Then, if a measurement calibration is performed over a frequency range exceeding a single standard, additional standards can be used for each portion of the range.

Lastly, the standard must be defined as either coaxial or waveguide. If it is waveguide, dispersion effects are calculated automatically and included in the standard model.

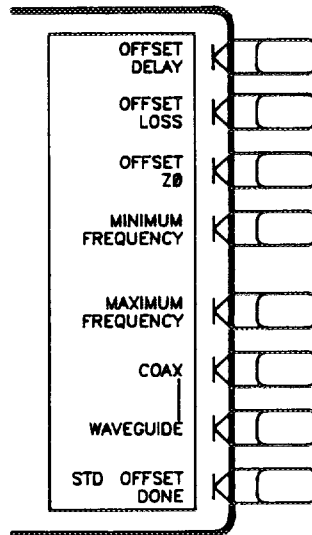

Figure 5-28. Specify Offset Menu

[OFFSET DELAY] (OFSD) is used to specify the one-way electrical delay from the measurement (reference) plane to the standard, in seconds (s). (In a transmission standard, offset delay is the delay from plane to plane.) Delay can be calculated from the precise physical length of the offset, the permittivity constant of the medium, and the speed of light.

In coax, group delay is considered constant. In waveguide, however, group delay is dispersive, that is, it changes significantly as a function of frequency. Hence, for a waveguide standard, offset delay must be defined at an infinitely high frequency.

[OFFSET LOSS] (OFSL) is used to specify energy loss, due to skin effect, along a one-way length of coax offset. The value of loss is entered as ohms/nanosecond (or Giga ohms/second) at 1 GHz. (Such losses are negligible in waveguide, so enter 0 as the loss offset.)

[OFFSET Z0] (OFSZ) is used to specify the characteristic impedance of the coax offset. (Note: This is *not* the impedance of the standard itself.) (For waveguide, the offset impedance is always assigned a value equal to the system Z0.)

[MINIMUM FREQUENCY] (MINF) is used to define the lowest frequency at which the standard can be used during measurement calibration. In waveguide, this *must* be the lower cutoff frequency of the standard, so that the analyzer can calculate dispersive effects correctly (see **[OFFSET DELAY]** above).

[MAXIMUM FREQUENCY] (MAXF) is used to define the highest frequency at which the standard can be used during measurement calibration. In waveguide, this is normally the upper cutoff frequency of the standard.

[COAX] (COAX) defines the standard (and the offset) as coaxial. This causes the analyzer to assume linear phase response in any offsets.

[WAVEGUIDE] (WAVE) defines the standard (and the offset) as rectangular waveguide. This causes the analyzer to assume a dispersive delay (see **[OFFSET DELAY]** above).

Label Standard Menu (LABS)

This menu is used to label (reference) individual standards during the menu-driven measurement calibration sequence. The labels are user-definable using a character set displayed on the CRT that includes letters, numbers, and some symbols, and they may be up to ten characters long. The analyzer will prompt you to connect standards using these labels, so they should be *meaningful* to you, and distinct for each standard.

By convention, when sexed connector standards are labeled male (m) or female (f), the designation refers to the test port connector sex, not the connector sex of the standard.

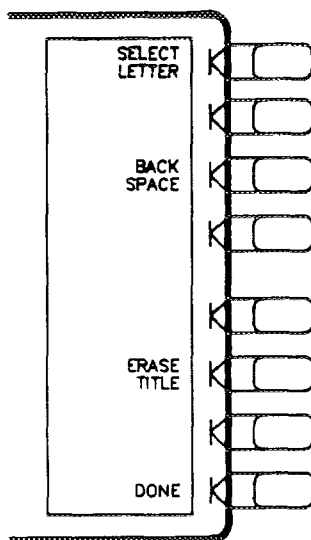

Figure 5-29. Label Standard Menu

Standard labels are created in the same way as titles. Refer to **[DISPLAY] Key, Title Menu** in Chapter 4.

Specify Class Menus

Once a standard is specified, it must be assigned to a standard "class". This is a group of from one to seven standards that is required to calibrate for a single error term. The standards within a single class are assigned to locations A through G as listed on the *Standard Class Assignments Table* (Table 5-6). A class often consists of a single standard, but may be composed of more than one standard if band-limited standards are used. (Example: All default calibration kits for the analyzer have a single load standard per class, since all are broadband in nature. However, if there were two load standards – a fixed load for low frequencies, and a sliding load for high frequencies – then that class would have two standards.)

Table 5-6. Standard Class Assignments Table

	A	B	C	D	E	F	G	STANDARD CLASS LABEL
S ₁₁ A								
S ₁₁ B								
S ₁₁ C								
S ₂₂ A								
S ₂₂ B								
S ₂₂ C								
Forward Transmission								
Reverse Transmission								
Forward Match								
Reverse Match								
Response								
Response & Isolation								

The number of standard classes required depends on the type of calibration being performed, and is identical to the number of error terms corrected. (Examples: A response cal requires only one class, and the standards for that class may include an open, or short, or thru. A 1-port cal requires three classes. A full 2-port cal requires 10 classes, not including two for isolation.)

The number of standards that can be assigned to a given class may vary from none (class not used) to one (simplest class) to seven. When a certain class of standards is required during calibration, the analyzer will display the labels for *all* the standards in that class (except when the class consists of a single standard). This does not, however, mean that all standards in a class must be measured during calibration. Unless band-limited standards are used, only a single standard per class is required. Note that it is often simpler to keep the number of standards per class to the bare minimum needed (often one) to avoid confusion during calibration.

Standards are assigned to a class simply by entering the standard's reference number (established while defining a standard) under a particular class.

Each class can be given a user-definable label as described under *Label Class Menus*.

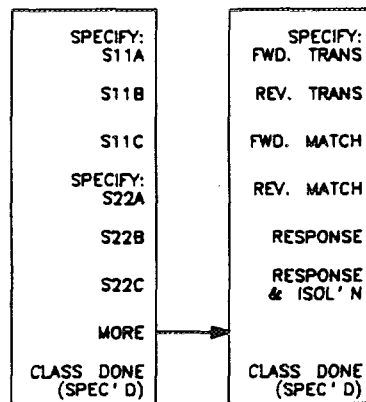

Figure 5-30. Specify Class Menus

[SPECIFY: S11A] (SPECS11A) is used to enter the standard numbers for the first class required for an S_{11} 1-port calibration. (For default cal kits, this is the open.)

[S11B] (SPECS11B) is used to enter the standard numbers for the second class required for an S_{11} 1-port calibration. (For default cal kits, this is the short.)

[S11C] (SPECS11C) is used to enter the standard numbers for the third class required for an S_{11} 1-port calibration. (For default kits, this is the load.)

[SPECIFY: S22A] (SPECS22A) is used to enter the standard numbers for the first class required for an S_{22} 1-port calibration. (For default cal kits, this is the open.)

[S22B] (SPECS22B) is used to enter the standard numbers for the second class required for an S_{22} 1-port calibration. (For default cal kits, this is the short.)

[S22C] (SPECS22C) is used to enter the standard numbers for the third class required for an S_{22} 1-port calibration. (For default kits, this is the load.)

[MORE] leads to the following softkeys.

[FWD.TRANS.] (SPECFWDT) is used to enter the standard numbers for the forward transmission thru calibration. (For default kits, this is the thru.)

[REV.TRANS.] (SPECREVT) is used to enter the standard numbers for the reverse transmission (thru) calibration. (For default kits, this is the thru.)

[FWD.MATCH] (SPECFWDM) is used to enter the standard numbers for the forward match (thru) calibration. (For default kits, this is the thru.)

[REV.MATCH] (SPECREVM) is used to enter the standard numbers for the reverse match (thru) calibration. (For default kits, this is the thru.)

[RESPONSE] (SPECRESP) is used to enter the standard numbers for a response calibration. This calibration corrects for frequency response in either reflection or transmission measurements, depending on the parameter being measured when a calibration is performed. (For default kits, the standard is either the open or short for reflection measurements, or the thru for transmission measurements.)

[RESPONSE & ISOL'N] (SPECRESI) is used to enter the standard numbers for a response & isolation calibration. This calibration corrects for frequency response and directivity in reflection measurements, or frequency response and isolation in transmission measurements.

Label Class Menus

The label class menus are used to define meaningful labels for the calibration classes. These then become softkey labels during a measurement calibration. Labels can be up to ten characters long.

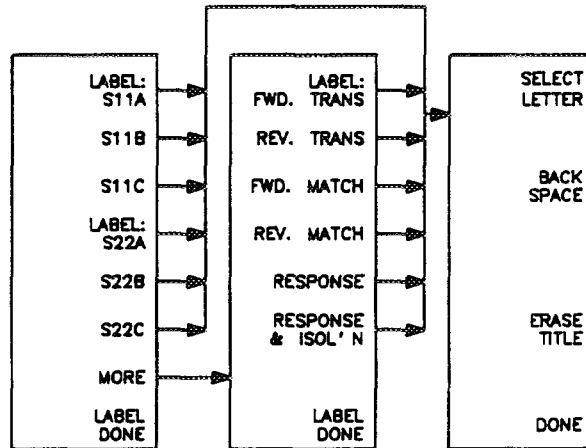

Figure 5-31. Label Class Menus

Labels are created in the same way as display titles. Refer to *[DISPLAY] Key, Title Menu* in Chapter 4.

Label Kit Menu

After a new calibration kit has been defined, be sure to specify a label for it. Choose a label that describes the connector type of the calibration devices. This label will then appear in the *[CAL KIT]* softkey label in the correction menu and the *[MODIFY]* label in the select cal kit menu. It will be saved with calibration sets.

This menu is accessed with the *[LABEL KIT]* softkey in the modify cal kit menu, and is identical to the label class menu and the label standard menu described above. It allows definition of a label up to eight characters long.

Verify Performance

Once a measurement calibration has been generated with a user-defined calibration kit, its performance should be checked before making device measurements. To check the accuracy that can be obtained using the new calibration kit, a device with a well-defined frequency response (preferably unlike any of the standards used) should be measured. The verification device must not be one of the calibration standards: measurement of one of these standards is merely a measure of repeatability.

To achieve more complete verification of a particular measurement calibration, accurately known verification standards with a diverse magnitude and phase response should be used. NIST traceable or HP standards are recommended to achieve verifiable measurement accuracy.

NOTE: The published specifications for the HP 8753C network analyzer system include accuracy enhancement with compatible calibration kits. Measurement calibrations made with user-defined or modified calibration kits are not subject to the HP 8753C specifications, although a procedure similar to the system verification procedure may be used.

Example Procedure for Specifying a User-Defined Calibration Kit

The following procedure enters the HP 85033C 3.5 mm calibration kit values as a "user kit." This is provided as an example to illustrate the steps required in defining a calibration kit model.

NOTE: Numerical data for most Hewlett-Packard calibration kits is provided in the calibration kit manuals.

The first keystroke sequence enters the values for standard #1, the short circuit.

- **[CAL] [CAL KIT] [MODIFY]**
- **[DEFINE STANDARD] [SHORT]**
- **[SPECIFY OFFSET] [OFFSET DELAY] [.] [0] [1] [6] [6] [9] [5] [G/n]**
- **[STD OFFSET DONE] [STD DONE (DEFINED)]**

The next sequence specifies standard #2, the open circuit.

- **[DEFINE STANDARD] [2] [x1] [OPEN]**
- **[C0] [5] [3] [x1]**
- **[C1] [1] [5] [0] [x1]**
- **[C2] [0] [x1]**
- **[C3] [0] [x1]**
- **[SPECIFY OFFSET] [OFFSET DELAY] [.] [0] [1] [4] [4] [9] [1] [G/n]**
- **[STD OFFSET DONE] [STD DONE (DEFINED)]**

The next sequence specifies standard #3, the lowband load.

- **[DEFINE STANDARD] [3] [x1] [LOAD]**
- **[SPECIFY OFFSET] [MAXIMUM FREQUENCY] [6] [.] [0] [0] [1] [G/n]**
- **[STD OFFSET DONE] [STD DONE (DEFINED)]**

The final sequence labels the kit and saves it in memory.

- **[LABEL KIT]**
- Use the knob and softkeys to modify the label to read "3.5mmC"
- **[DONE] [KIT DONE (MODIFIED)]**

- **[CAL]**
- **[CAL KIT [3.5mmC]]**
- **[SAVE USER KIT] [USER KIT]**

The **[USER KIT]** softkey is now underlined, and the user-specified kit definition is saved in non-volatile memory.

ACCURACY ENHANCEMENT FUNDAMENTALS—CHARACTERIZING MICROWAVE SYSTEMATIC ERRORS

One-Port Error Model

In a measurement of the reflection coefficient (magnitude and phase) of an unknown device, the measured data differs from the actual, no matter how carefully the measurement is made. Directivity, source match, and reflection signal path frequency response (tracking) are the major sources of error (Figure 5-32).

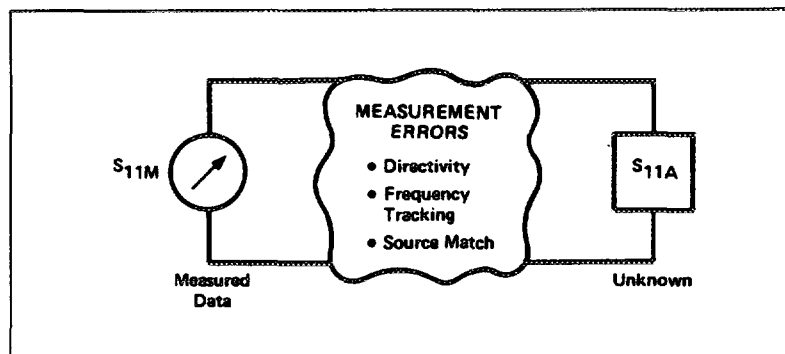

Figure 5-32. Sources of Error in a Reflection Measurement

The reflection coefficient is measured by first separating the incident signal (I) from the reflected signal (R), then taking the ratio of the two values (Figure 5-33). Ideally, (R) consists only of the signal reflected by the test device (S11A).

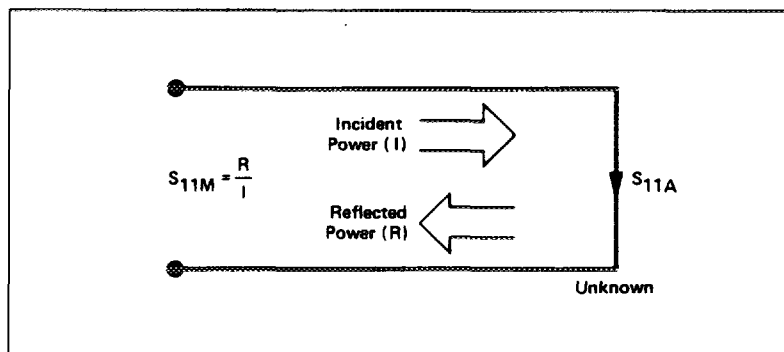

Figure 5-33. Reflection Coefficient

However, all of the incident signal does not always reach the unknown (see Figure 5-34). Some of (I) may appear at the measurement system input due to leakage through the test set or other signal separation device. Also, some of (I) may be reflected by imperfect adapters between signal separation and the measurement plane. The vector sum of the leakage and miscellaneous reflections is directivity, EDF. Understandably, the measurement is distorted when the directivity signal combines vectorally with the actual reflected signal from the unknown, S_{11A}.

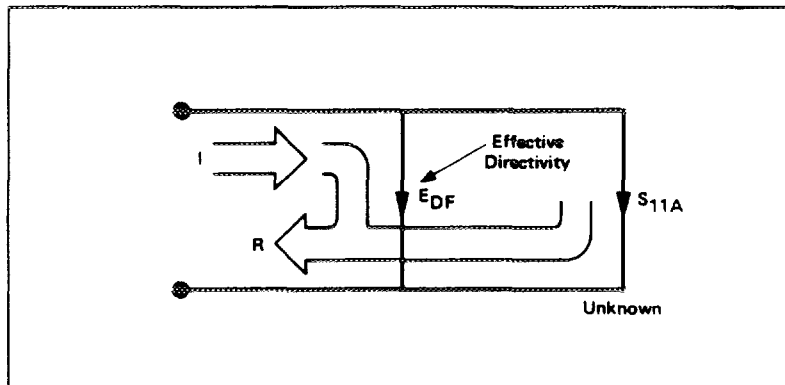

Figure 5-34. Effective Directivity EDF

Since the measurement system test port is never exactly the characteristic impedance (50 ohms or 75 ohms), some of the reflected signal bounces off the test port, or other impedance transitions further down the line, and back to the unknown, adding to the original incident signal (I). This effect causes the magnitude and phase of the incident signal to vary as a function of S_{11A} and frequency. Leveling the source to produce constant (I) reduces this error, but since the source cannot be exactly leveled at the test device input, leveling cannot eliminate all power variations. This re-reflection effect and the resultant incident power variation are caused by the source match error, ESF (Figure 5-35).

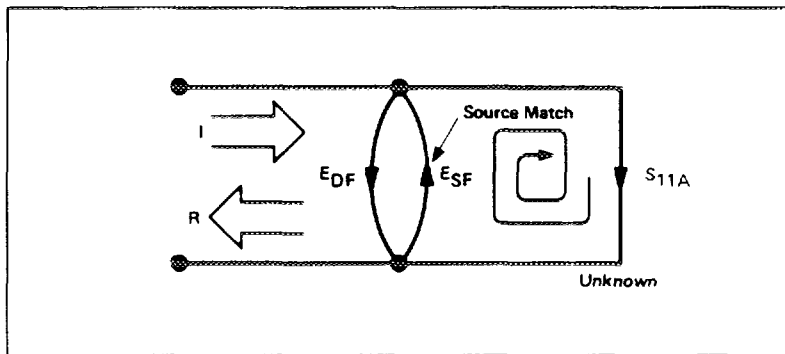

Figure 5-35. Source Match ESF

Frequency response (tracking) error is caused by variations in magnitude and phase flatness versus frequency between the test and reference signal paths. These are due mainly to imperfectly matched samplers and differences in length and loss between incident and test signal paths. The vector sum of these variations is the reflection signal path tracking error, ERF (Figure 5-36).

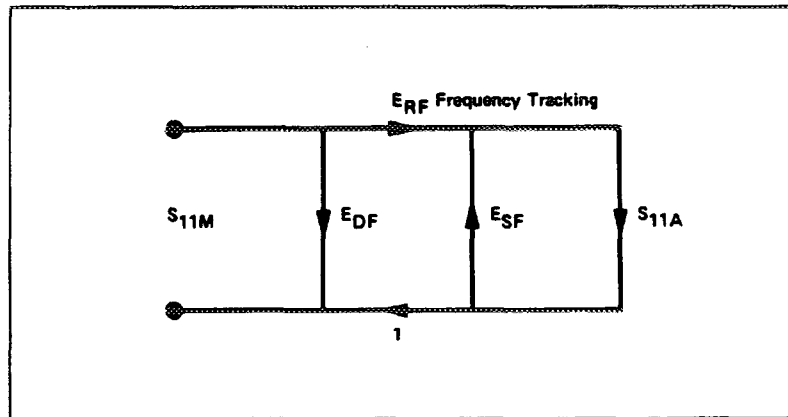

Figure 5-36. Reflection Tracking ERF

These three errors are mathematically related to the actual data, S_{11A}, and measured data, S_{11M}, by the following equation:

$$S_{11M} = E_{DF} + \frac{S_{11A} (E_{RF})}{1 - E_{SF} S_{11A}}$$

If the value of these three "E" errors and the measured test device response were known for each frequency, the above equation could be solved for S_{11A} to obtain the actual test device response. Because each of these errors changes with frequency, their values must be known at each test frequency. These values are found by measuring the system at the measurement plane using three independent standards whose S_{11A} is known at all frequencies.

The first standard applied is a "perfect load", which makes $S_{11A} = 0$ and essentially measures directivity (Figure 5-37). "Perfect load" implies a reflectionless termination at the measurement plane. All incident energy is absorbed. With $S_{11A} = 0$ the equation can be solved for EDF, the directivity term. In practice, of course, the "perfect load" is difficult to achieve, although very good broadband loads are available in the HP 8753 compatible calibration kits.

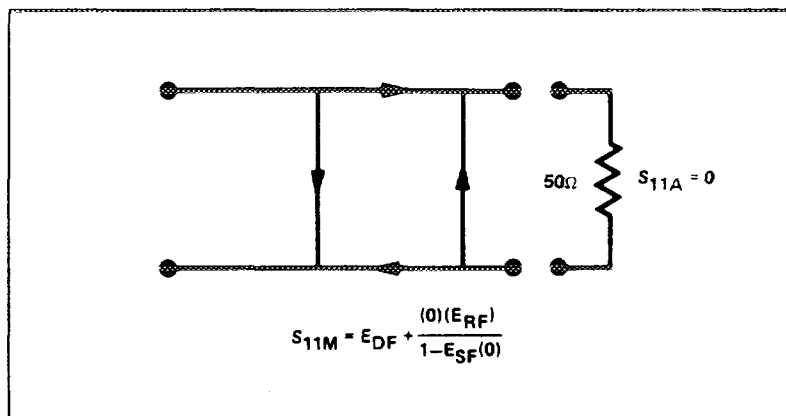

Figure 5-37. "Perfect Load" Termination

Since the measured value for directivity is the vector sum of the actual directivity plus the actual reflection coefficient of the "perfect load," any reflection from the termination represents an error. System effective directivity becomes the actual reflection coefficient of the "perfect load" (Figure 5-38). In general, any termination having a return loss value greater than the uncorrected system directivity reduces reflection measurement uncertainty.

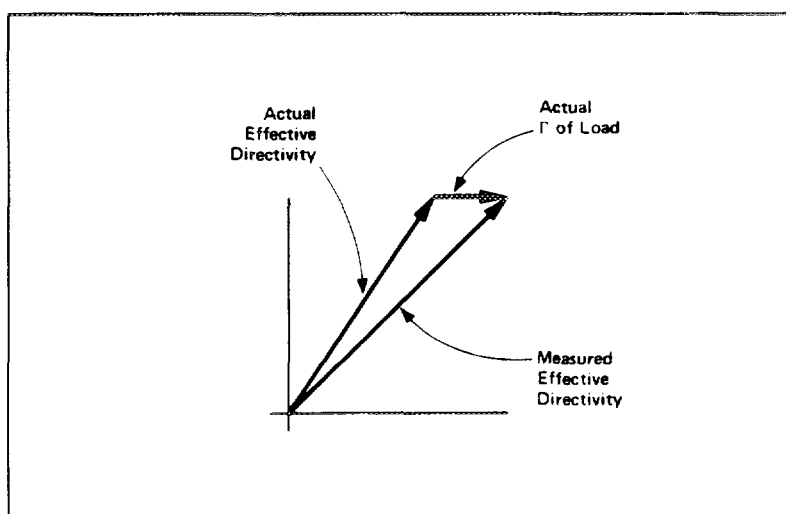

Figure 5-38. Measured Effective Directivity

Next, a short circuit termination whose response is known to a very high degree is used to establish another condition (Figure 5-39).

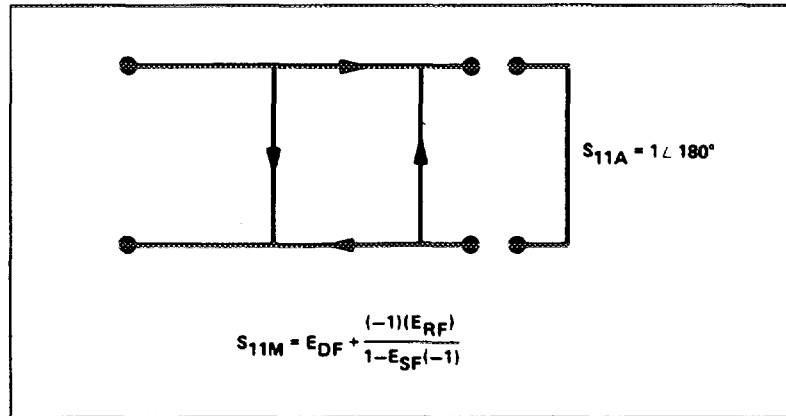

Figure 5-39. Short Circuit Termination

The open circuit gives the third independent condition. In order to accurately model the phase variation with frequency due to radiation from the open connector, a specially designed shielded open circuit is used for this step. (The open circuit capacitance is different with each connector type). Now the values for EDF, directivity, ESF, source match, and ERF, reflection frequency response, are computed and stored (Figure 5-40).

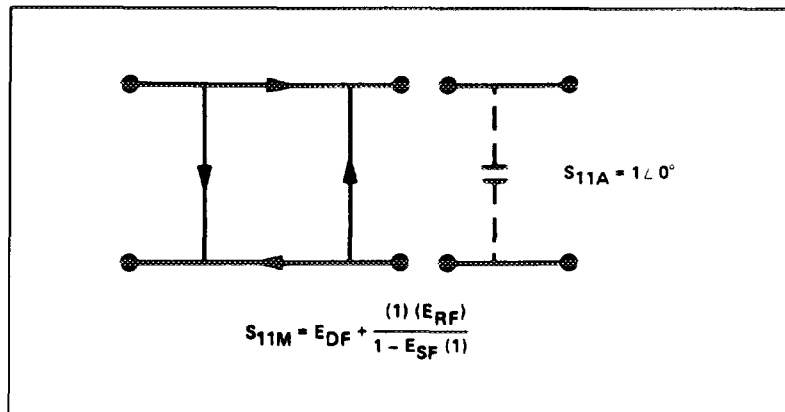

Figure 5-40. Open Circuit Termination

Now the unknown is measured to obtain a value for the measured response, S_{11M} , at each frequency (Figure 5-41).

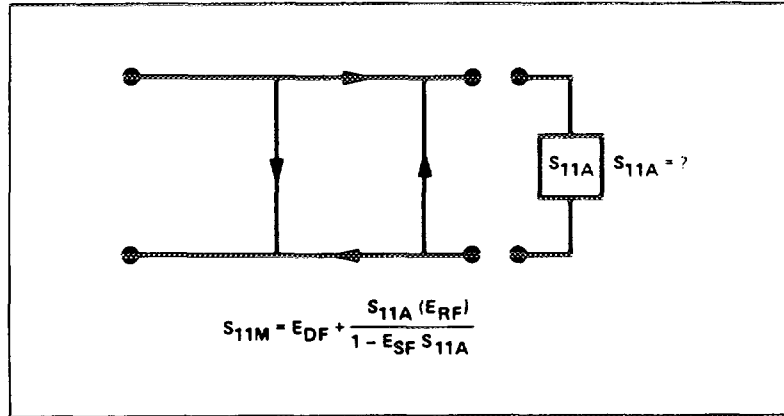

Figure 5-41. Measured S_{11}

This is the one-port error model equation solved for S_{11A} . Since the three errors and S_{11M} are now known for each test frequency, S_{11A} can be computed as follows:

$$S_{11A} = \frac{S_{11M} - E_{DF}}{E_{SF} (S_{11M} - E_{DF}) + E_{RF}}$$

For reflection measurements on two-port devices, the same technique can be applied, but the test device output port must be terminated in the system characteristic impedance. This termination should be at least as good (have as low a reflection coefficient) as the load used to determine directivity. The additional reflection error caused by an improper termination at the test device output port is not incorporated into the one-port error model.

Two-Port Error Model

The error model for measurement of the transmission coefficients (magnitude and phase) of a two-port device is derived in a similar manner. The major sources of error are frequency response (tracking), source match, load match, and isolation (Figure 5-42). These errors are effectively removed using the full two-port error model.

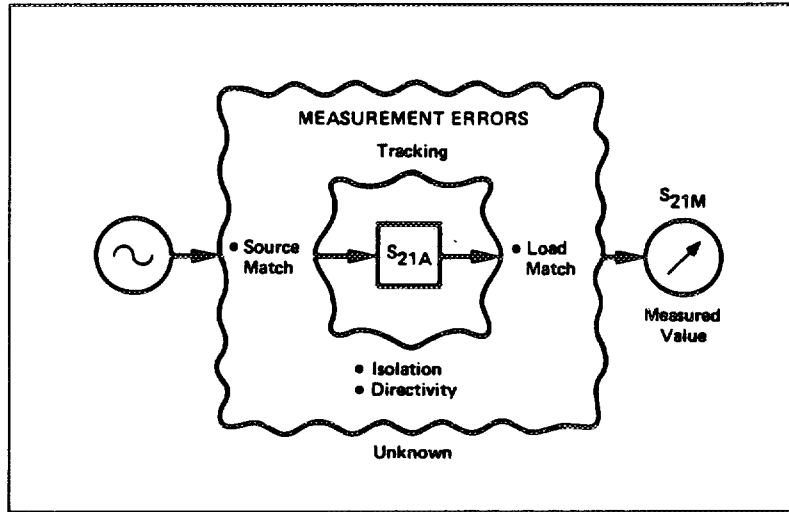

Figure 5-42. Major Sources of Error

The transmission coefficient is measured by taking the ratio of the incident signal (I) and the transmitted signal (T) (Figure 5-43). Ideally, (I) consists only of power delivered by the source, and (T) consists only of power emerging at the test device output.

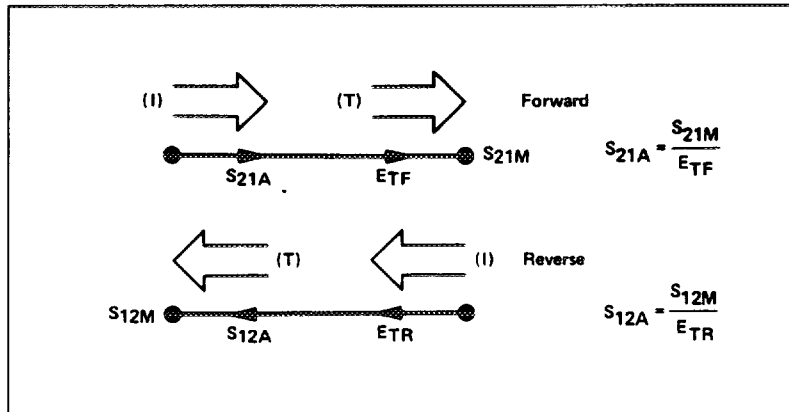

Figure 5-43. Transmission Coefficient

As in the reflection model, source match can cause the incident signal to vary as a function of test device S_{11A} . Also, since the test setup transmission return port is never exactly the characteristic impedance, some of the transmitted signal is reflected from the test set port 2, and from other mismatches between the test device output and the receiver input, to return to the test device. A portion of this signal may be re-reflected at port 2, thus affecting S_{21M} , or part may be transmitted through the device in the reverse direction to appear at port 1, thus affecting S_{11M} . This error term, which causes the magnitude and phase of the transmitted signal to vary as a function of S_{22A} , is called load match, ELF (Figure 5-44).

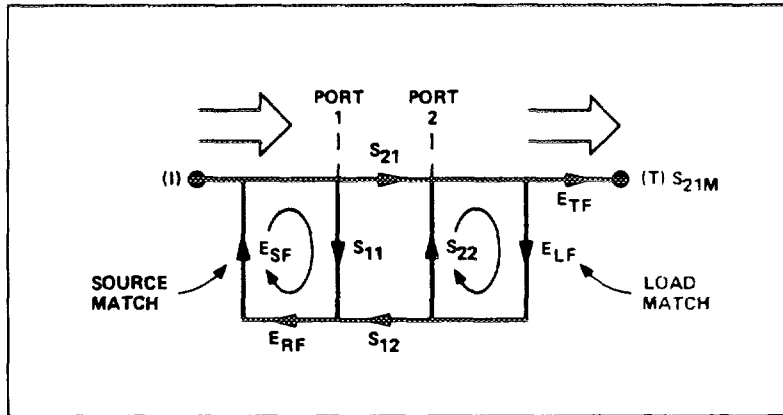

Figure 5-44. Load Match ELF

The measured value, S_{21M} , consists of signal components that vary as a function of the relationship between E_{SF} and S_{11A} as well as E_{LF} and S_{22A} , so the input and output reflection coefficients of the test device must be measured and stored for use in the S_{21A} error correction computation. Thus, the test setup is calibrated as described above for reflection to establish the directivity, E_{DF} , source match, E_{SF} , and reflection frequency response, E_{RF} , terms for the reflection measurements.

Now that a calibrated port is available for reflection measurements, the thru is connected and load match, E_{LF} , is determined by measuring the reflection coefficient of the thru connection.

Transmission signal path frequency response is then measured with the thru connected. The data is corrected for source and load match effects, then stored as transmission frequency response, E_{TF} .

Isolation, E_{XF} , represents the part of the incident signal that appears at the receiver without actually passing through the test device (Figure 5-45). Isolation is measured with the test set in the transmission configuration and with terminations installed at the points where the test device will be connected.

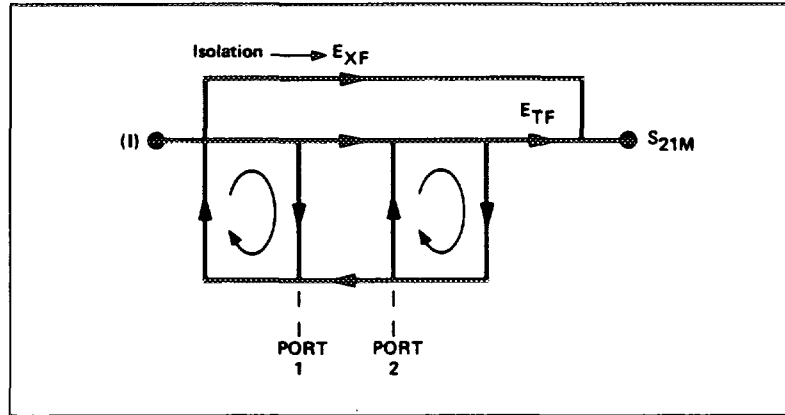

Figure 5-45. Isolation E_{XF}

Thus there are two sets of error terms, forward and reverse, with each set consisting of six error terms, as follows:

- Directivity, EDF (forward) and EDR (reverse)
- Isolation, E_{XF} and E_{XR}
- Source Match, ESF and ESR
- Load Match, ELF and ELR
- Transmission Tracking, ETF and ETR
- Reflection Tracking, ERF and ERR.

The HP 85046A/B and 85047A S-parameter Test Sets can measure both the forward and reverse characteristics of the test device without the need to manually remove and physically reverse it. With these test sets, the full two-port error model illustrated in Figure 5-46 effectively removes both the forward and reverse error terms for transmission and reflection measurements.

The HP 85044A/B Transmission/Reflection Test Sets cannot switch between forward and reverse directions, so the reverse error terms cannot be automatically measured. Therefore, with the one-path two-port calibration, the forward error terms are duplicated and used for both forward and reverse measurements by manually reversing the test device.

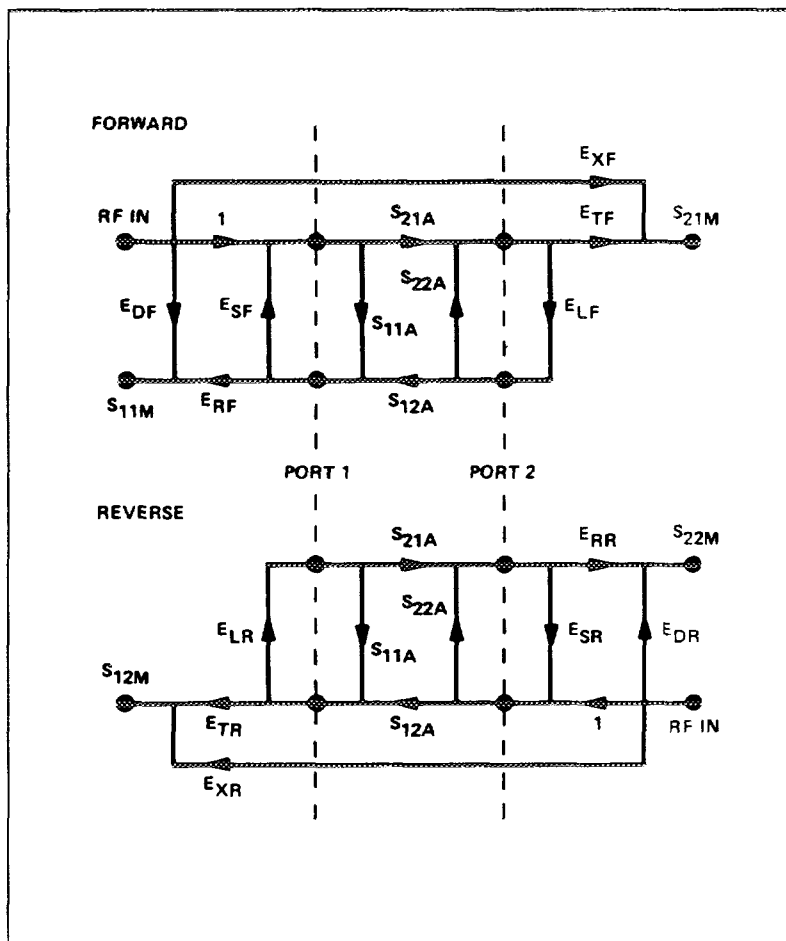

Figure 5-46. Full Two-Port Error Model

Figure 5-47 shows the full two-port error model equations for all four S-parameters of a two-port device. Note that the mathematics for this comprehensive model use all forward and reverse error terms and measured values. Thus, to perform full error correction for any one parameter, all four S-parameters must be measured.

Applications of these error models are provided in the calibration procedures described in Chapter 5.

$$S_{11A} = \frac{\left[\left(\frac{S_{11M} - E_{DF}}{E_{RF}} \right) \left[1 + \left(\frac{S_{22M} - E_{DR}}{E_{RR}} \right) E_{SR} \right] \right] - \left[\left(\frac{S_{21M} - E_{XF}}{E_{TF}} \right) \left(\frac{S_{12M} - E_{XR}}{E_{TR}} \right) E_{LF} \right]}{\left[1 + \left(\frac{S_{11M} - E_{DF}}{E_{RF}} \right) E_{SF} \right] \left[1 + \left(\frac{S_{22M} - E_{DR}}{E_{RR}} \right) E_{SR} \right] - \left[\left(\frac{S_{21M} - E_{XF}}{E_{TF}} \right) \left(\frac{S_{12M} - E_{XR}}{E_{TR}} \right) E_{LF} E_{LR} \right]}$$

$$S_{21A} = \frac{\left[1 + \left(\frac{S_{22M} - E_{DR}}{E_{RR}} \right) (E_{SR} - E_{LF}) \right] \left(\frac{S_{21M} - E_{XF}}{E_{TF}} \right)}{\left[1 + \left(\frac{S_{11M} - E_{DF}}{E_{RF}} \right) E_{SF} \right] \left[1 + \left(\frac{S_{22M} - E_{DR}}{E_{RR}} \right) E_{SR} \right] - \left[\left(\frac{S_{21M} - E_{XF}}{E_{TF}} \right) \left(\frac{S_{12M} - E_{XR}}{E_{TR}} \right) E_{LF} E_{LR} \right]}$$

$$S_{12A} = \frac{\left[1 + \left(\frac{S_{11M} - E_{DF}}{E_{RF}} \right) (E_{SF} - E_{LR}) \right] \left(\frac{S_{12M} - E_{XR}}{E_{TR}} \right)}{\left[1 + \left(\frac{S_{11M} - E_{DF}}{E_{RF}} \right) E_{SF} \right] \left[1 + \left(\frac{S_{22M} - E_{DR}}{E_{RR}} \right) E_{SR} \right] - \left[\left(\frac{S_{21M} - E_{XF}}{E_{TF}} \right) \left(\frac{S_{12M} - E_{XR}}{E_{TR}} \right) E_{LF} E_{LR} \right]}$$

$$S_{22A} = \frac{\left[\left(\frac{S_{22M} - E_{DR}}{E_{RR}} \right) \left[1 + \left(\frac{S_{11M} - E_{DF}}{E_{RF}} \right) E_{SF} \right] \right] - \left[\left(\frac{S_{21M} - E_{XF}}{E_{TF}} \right) \left(\frac{S_{12M} - E_{XR}}{E_{TR}} \right) E_{LR} \right]}{\left[1 + \left(\frac{S_{11M} - E_{DF}}{E_{RF}} \right) E_{SF} \right] \left[1 + \left(\frac{S_{22M} - E_{DR}}{E_{RR}} \right) E_{SR} \right] - \left[\left(\frac{S_{21M} - E_{XF}}{E_{TF}} \right) \left(\frac{S_{12M} - E_{XR}}{E_{TR}} \right) E_{LF} E_{LR} \right]}$$

Figure 5-47. Full Two-Port Error Model Equations

In addition to the errors removed by accuracy enhancement, other systematic errors exist due to limitations of dynamic accuracy, test set switch repeatability, and test cable stability. These, combined with random errors, also contribute to total system measurement uncertainty. Therefore, after accuracy enhancement procedures are performed, residual measurement uncertainties remain. *System Performance* in the *General Information and Specifications* section of this manual provides information for calculating the system's total error-corrected measurement uncertainty performance.

Chapter 6. Using Markers

CHAPTER CONTENTS

- 6-1 [MKR] Key
- 6-4 Marker Menu
- 6-5 Delta Marker Mode Menu
- 6-6 Fixed Marker Menu
- 6-8 Marker Mode Menu
- 6-9 Polar Marker Menu
- 6-10 Smith Marker Menu
- 6-11 [MKR FCTN] Key
- 6-11 Marker Function Menu
- 6-13 Marker Search Menu
- 6-14 Target Menu

[MKR] KEY

The HP-IB programming command is shown in parenthesis following the key or softkey.

The [MKR] (MENUMARK) key displays a movable active marker (∇) on the screen and provides access to a series of menus to control one to four display markers for each channel (a total of eight). Markers are used to obtain numerical readings of measured values. They also provide capabilities for reducing measurement time by changing stimulus parameters, searching the trace for specific values, or statistically analyzing part or all of the trace. Figure 6-1 illustrates the displayed trace with all markers on and marker 1 the active marker.

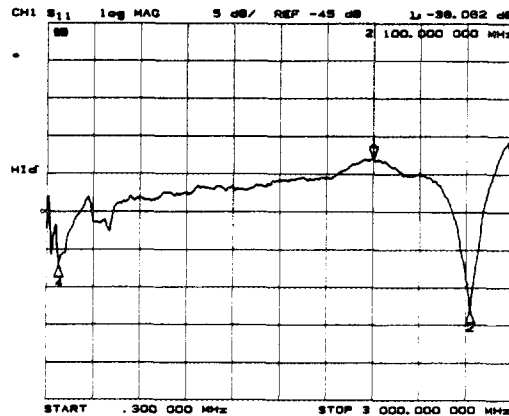

Figure 6-1. Markers on Trace

Markers have a stimulus value (the x-axis value in a Cartesian format) and a response value (the y-axis value in a Cartesian format). In a polar or Smith chart format, the second part of a complex data pair is also provided as an auxiliary response value. When a marker is turned on and no other function is active, its stimulus value is displayed in the active entry area and can be controlled with the knob, the step keys, or the numeric keypad. The active marker can be moved to any point on the trace, and its response and stimulus values are displayed at the top right corner of the graticule for each displayed channel, in units appropriate to the display format. The displayed marker response values are valid even when the measured data is above or below the range displayed on the graticule.

Marker values are normally continuous: that is, they are interpolated between measured points. Alternatively, they can be set to read only discrete measured points. The markers for the two channels normally have the same stimulus values, or they can be uncoupled so that each channel has independent markers, regardless of whether stimulus values are coupled or dual channel display is on.

If both data and memory are displayed, the marker values apply to the data trace. If memory only is displayed, the marker values apply to the memory trace. In a memory math display (data/memory or data-memory), the marker values apply to the trace resulting from the memory math function.

With the use of a reference marker, a delta marker mode is available that displays both the stimulus and response values of the active marker relative to the reference. Any of the four markers or a fixed point can be designated as the delta reference marker. If the delta reference is one of the four markers, its stimulus value can be controlled by the user and its response value is the value of the trace at that stimulus value. If the delta reference is a fixed marker, both its stimulus value and its response value can be set arbitrarily by the user anywhere in the display area (not necessarily on the trace).

Markers can be used to search for the trace maximum or minimum point or any other point on the trace. The four markers can be used together to search for specified bandwidth cutoff points and calculate the bandwidth and Q values. Statistical analysis uses markers to provide a readout of the mean, standard deviation, and peak-to-peak values of all or part of the trace.

Basic marker operations are available in the menus accessed from the [MKR] key. The marker search and statistical functions, together with the capability for quickly changing stimulus parameters with markers, are provided in the menus accessed from the [MKR FCTN] key.

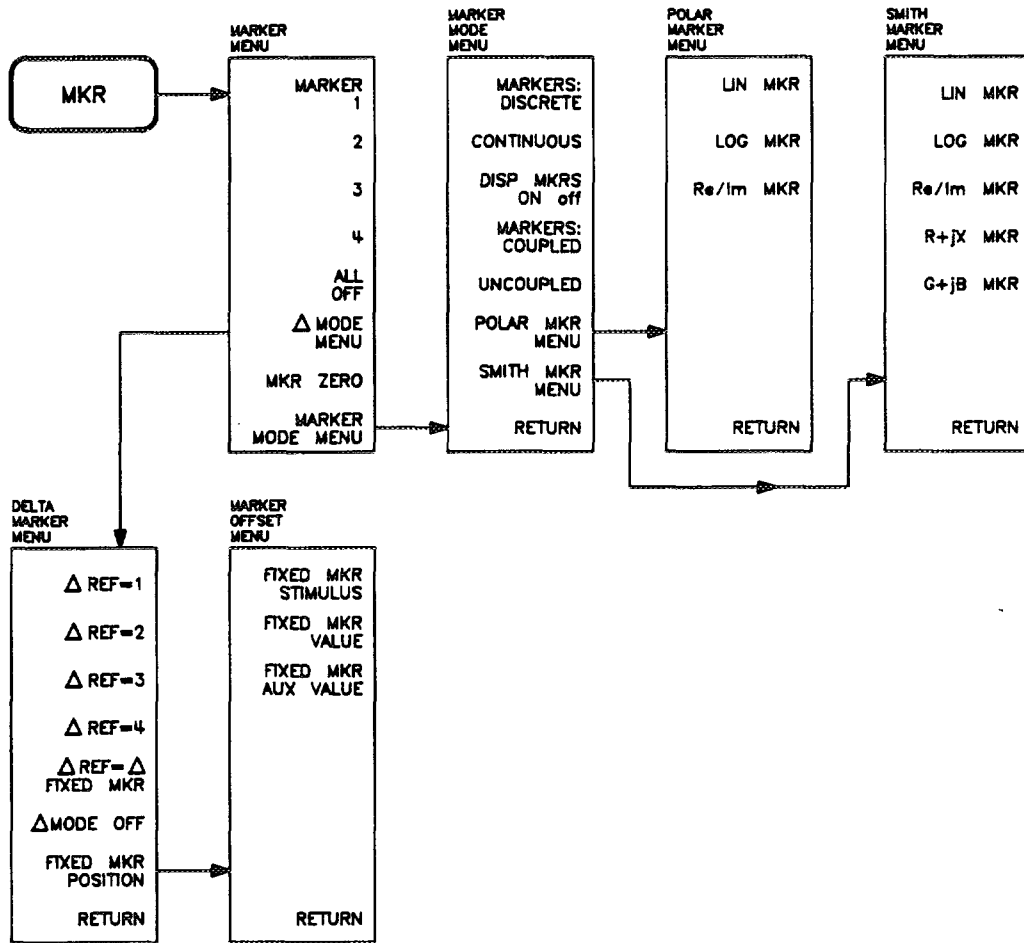

Figure 6-2. Menus Accessed from the [MKR] Key

The menus accessed from the [MKR] key (Figure 6-2) provide several basic marker operations. These include different marker modes for different display formats, and the delta marker mode that displays marker values relative to a specified value.

Marker Menu

The marker menu (Figure 6-3) is used to turn the display markers on or off, to designate the active marker, and to gain access to the marker delta mode and other marker modes and formats.

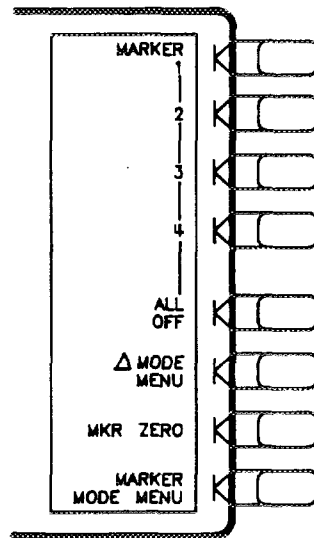

Figure 6-3. Marker Menu

[MARKER 1] (MARK1) turns on marker 1 and makes it the active marker. The active marker appears on the CRT as ∇ . The active marker stimulus value is displayed in the active entry area, together with the marker number. If there is a marker turned on, and no other function is active, the stimulus value of the active marker can be controlled with the knob, the step keys, or the numeric keypad. The marker response and stimulus values are displayed in the upper right-hand corner of the screen.

[MARKER 2] (MARK2) turns on marker 2 and makes it the active marker. If another marker is present, that marker becomes inactive and is represented on the CRT as Δ .

[MARKER 3] (MARK3) turns on marker 3 and makes it the active marker.

[MARKER 4] (MARK4) turns on marker 4 and makes it the active marker.

[ALL OFF] (MARKOFF) turns off all the markers and the delta reference marker, as well as the tracking and bandwidth functions that are accessed with the **[MKR FCTN]** key.

[Δ MODE MENU] goes to the delta marker menu, which is used to read the difference in values between the active marker and a reference marker.

[MKR ZERO] (MARKZERO) puts a fixed reference marker at the present active marker position, and makes the fixed marker stimulus and response values at that position equal to zero. All subsequent stimulus and response values of the active marker are then read out relative to the fixed marker. The fixed marker is shown on the CRT as a small triangle Δ (delta), smaller than the inactive marker triangles. The softkey label changes from **[MKR ZERO]** to **[MKR ZERO Δ REF = Δ]** and the notation "ΔREF = Δ" is displayed at the top right corner of the graticule. Marker zero is canceled by turning delta mode off in the delta marker menu or turning all the markers off with the **[ALL OFF]** softkey.

[MARKER MODE MENU] provides access to the marker mode menu, where several marker modes can be selected including special markers for polar and Smith chart formats.

Delta Marker Mode Menu

The delta marker mode is used to read the difference in stimulus and response values between the active marker and a designated delta reference marker. Any of the four markers or a fixed point can be designated as the reference marker. If the reference is one of the four markers, its stimulus value can be controlled by the user and its response value is the value of the trace at that stimulus value. If the reference is a fixed marker, both its stimulus value and its response value can be set arbitrarily by the user anywhere in the display area. The delta reference is shown on the CRT as a small triangle Δ (delta), smaller than the inactive marker triangles. If one of the markers is the reference, the triangle appears next to the marker number on the trace.

The marker values displayed in this mode are the stimulus and response values of the active marker minus the reference marker. If the active marker is also designated as the reference marker, the marker values are zero.

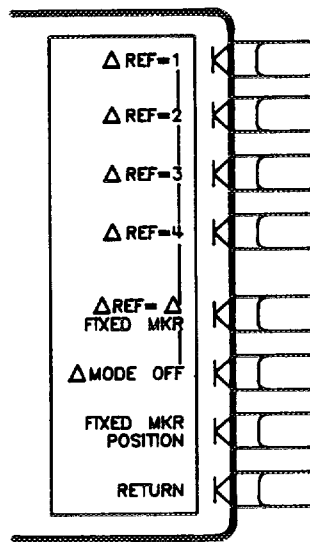

Figure 6-4. Delta Marker Mode Menu

[Δ REF = 1] (DELR1) establishes marker 1 as a reference. The active marker stimulus and response values are then shown relative to this delta reference. Once marker 1 has been selected as the delta reference, the softkey label [Δ REF = 1] is underlined in this menu, and the marker menu is returned to the screen. In the marker menu, the first key is now labeled [**MARKER Δ REF = 1**]. The notation " Δ REF=1" appears at the top right corner of the graticule.

[Δ REF = 2] (DELR2) makes marker 2 the delta reference. Active marker stimulus and response values are then shown relative to this reference.

[Δ REF = 3] (DELR3) makes marker 3 the delta reference.

[Δ REF = 4] (DELR4) makes marker 4 the delta reference.

[Δ REF = Δ FIXED MKR] (DELRFIXM) sets a user-specified fixed reference marker. The stimulus and response values of the reference can be set arbitrarily, and can be anywhere in the display area. Unlike markers 1 to 4, the fixed marker need not be on the trace. The fixed marker is indicated by a small triangle Δ , and the active marker stimulus and response values are shown relative to this point. The notation " Δ REF= Δ " is displayed at the top right corner of the graticule.

Pressing this softkey turns on the fixed marker. Its stimulus and response values can then be changed using the fixed marker menu, which is accessed with the **[FIXED MKR POSITION]** softkey described below. Alternatively, the fixed marker can be set to the current active marker position, using the **[MKR ZERO]** softkey in the marker menu.

[Δ MODE OFF] (DELO) turns off the delta marker mode, so that the values displayed for the active marker are absolute values.

[FIXED MKR POSITION] leads to the fixed marker menu, where the stimulus and response values for a fixed reference marker can be set arbitrarily.

Alternatively, the current position of the active marker can be entered as the fixed reference by using **[MARKER ZERO]** in the marker menu.

[RETURN] goes back to the marker menu.

Fixed Marker Menu

This menu is used to set the position of a fixed reference marker, indicated on the display by a small triangle Δ . Both the stimulus value and the response value of the fixed marker can be set arbitrarily anywhere in the display area, and need not be on the trace. The units are determined by the display format, the sweep type, and the marker type.

There are two ways to turn on the fixed marker. One way is with the **[Δ REF = Δ FIXED MKR]** softkey in the delta marker menu. The other is with the **[MKR ZERO]** function in the marker menu, which puts a fixed reference marker at the present active marker position and makes the marker stimulus and response values at that position equal to zero.

The softkeys in this menu make the values of the fixed marker the active function. The marker readings in the top right corner of the graticule are the stimulus and response values of the active marker minus the fixed reference marker. Also displayed in the top right corner is the notation " Δ REF= Δ ."

The stimulus value, response value, and auxiliary response value (the second part of a complex data pair) can be individually examined and changed. This allows active marker readings that are relative in amplitude yet absolute in frequency, or any combination of relative/absolute readouts. Following a **[MKR ZERO]** operation, this menu can be used to reset any of the fixed marker values to absolute zero for absolute readings of the subsequent active marker values.

If the format is changed while a fixed marker is on, the fixed marker values become invalid. For example, if the value offset is set to 10 dB with a log magnitude format, and the format is then changed to phase, the value offset becomes 10 degrees. However, in polar and Smith chart formats, the specified values remain consistent between different marker types for those formats. Thus an $R + jX$ marker set on a Smith chart format will retain the equivalent values if it is changed to any of the other Smith chart markers.

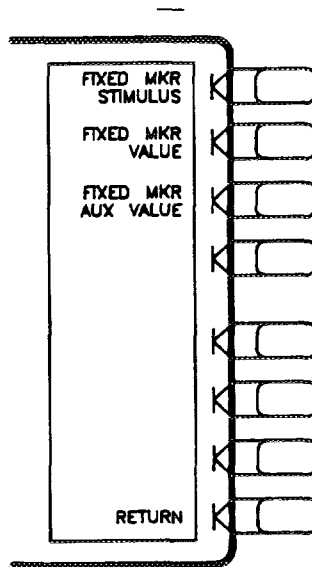

Figure 6-5. The Fixed Marker Menu

[FIXED MKR STIMULUS] (MARKFSTI) changes the stimulus value of the fixed marker. Fixed marker stimulus values can be different for the two channels if the channel markers are uncoupled using the marker mode menu.

To read absolute active marker stimulus values following a **[MKR ZERO]** operation, the stimulus value can be reset to zero.

[FIXED MKR VALUE] (MARKFVAL) changes the response value of the fixed marker. In a Cartesian format this is the y-axis value. In a polar or Smith chart format with a magnitude/phase marker, a real/imaginary marker, an $R + jX$ marker, or a $G + jB$ marker, this applies to the first part of the complex data pair. Fixed marker response values are always uncoupled in the two channels.

To read absolute active marker response values following a **[MKR ZERO]** operation, the response value can be reset to zero.

[FIXED MKR AUX VALUE] (MARKFAUV) is used only with a polar or Smith format. It changes the auxiliary response value of the fixed marker. This is the second part of a complex data pair, and applies to a magnitude/phase marker, a real/imaginary marker, an $R + jX$ marker, or a $G + jB$ marker. Fixed marker auxiliary response values are always uncoupled in the two channels.

To read absolute active marker auxiliary response values following a **[MKR ZERO]** operation, the auxiliary value can be reset to zero.

[RETURN] goes back to the delta marker menu.

Marker Mode Menu

This menu provides different marker modes and makes available two additional menus of special markers for use with Smith chart or polar formats.

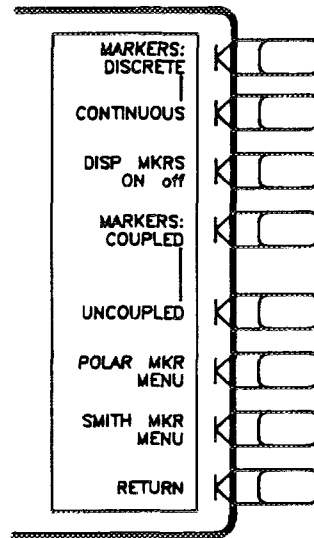

Figure 6-6. Marker Mode Menu

[MARKERS: DISCRETE] (MARKDISC) places markers only on measured trace points determined by the stimulus settings.

[CONTINUOUS] (MARKCONT) interpolates between measured points to allow the markers to be placed at any point on the trace. Displayed marker values are also interpolated. This is the default marker mode.

[DISP MKRS ON off] (DISM) displays response and stimulus values for all markers that are turned on. Available only if no marker functions are on.

[MARKERS: COUPLED] (MARKCOUP) couples the marker stimulus values for the two display channels. Even if the stimulus is uncoupled and two sets of stimulus values are shown, the markers track the same stimulus values on each channel as long as they are within the displayed stimulus range.

[UNCOUPLED] (MARKUNCO) allows the marker stimulus values to be controlled independently on each channel.

[POLAR MKR MENU] leads to a menu of special markers for use with a polar format.

[SMITH MKR MENU] leads to a menu of special markers for use with a Smith chart format.

[RETURN] goes back to the marker menu.

Polar Marker Menu

This menu is used only with a polar display format, selectable using the **[FORMAT]** key. In a polar format, the magnitude at the center of the circle is zero and the outer circle is the full scale value set in the scale reference menu. Phase is measured as the angle counterclockwise from 0° at the positive x-axis. The analyzer automatically calculates different mathematical forms of the marker magnitude and phase values, selected using the softkeys in this menu. Marker frequency is displayed in addition to other values regardless of the selection of marker type.

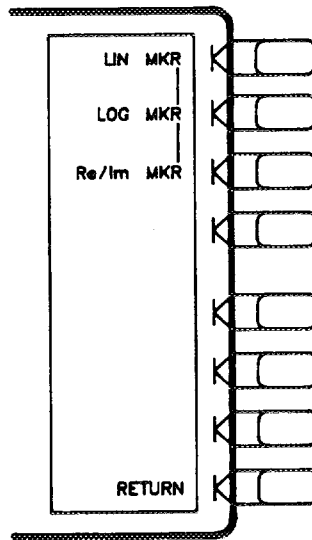

Figure 6-7. Polar Marker Menu

[LIN MKR] (POLMLIN) displays a readout of the linear magnitude and the phase of the active marker. This is the preset marker type for a polar display. Magnitude values are read in units and phase in degrees.

[LOG MKR] (POLMLOG) displays the logarithmic magnitude and the phase of the active marker. Magnitude values are expressed in dB and phase in degrees. This is useful as a fast method of obtaining a reading of the log magnitude value without changing to log magnitude format.

[Re/Im MKR] (POLMRI) displays the values of the active marker as a real and imaginary pair. The complex data is separated into its real part and imaginary part. The first marker value given is the real part $M \cos \theta$, and the second value is the imaginary part $M \sin \theta$, where M = magnitude.

[RETURN] goes back to the marker mode menu.

Smith Marker Menu

This menu is used only with a Smith chart format, selected from the format menu. The analyzer automatically calculates different mathematical forms of the marker magnitude and phase values, selected using the softkeys in this menu. Marker frequency is displayed in addition to other values for all marker types.

For additional information about the Smith chart display format, refer to *[FORMAT] Key*.

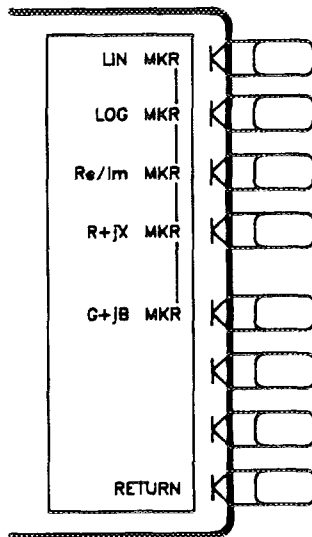

Figure 6-8. Smith Marker Menu

[LIN MKR] (SMIMLIN) displays a readout of the linear magnitude and the phase of the active marker. Marker magnitude values are expressed in units and phase in degrees.

[LOG MKR] (SMIMLOG) displays the logarithmic magnitude value and the phase of the active marker. Magnitude values are expressed in dB and phase in degrees. This is useful as a fast method of obtaining a reading of the log magnitude value without changing to log magnitude format.

[Re/Im MKR] (SMIMRI) displays the values of the active marker on a Smith chart as a real and imaginary pair. The complex data is separated into its real part and imaginary part. The first marker value given is the real part $M \cos \theta$, and the second value is the imaginary part $M \sin \theta$, where M = magnitude.

[R + jX MKR] (SMIMRX) converts the active marker values into rectangular form. The complex impedance values of the active marker are displayed in terms of resistance, reactance, and equivalent capacitance or inductance. This is the default Smith chart marker.

The normalized impedance Z_0 for characteristic impedances other than 50 ohms can be selected in the calibrate more menu (chapter 5).

[G + jB MKR] (SMIMGB) displays the complex admittance values of the active marker in rectangular form. The active marker values are displayed in terms of conductance (in Siemens), susceptance, and equivalent capacitance or inductance. Siemens are the international units of admittance, and are equivalent to mhos (the inverse of ohms).

[RETURN] goes back to the marker mode menu.

[MKR FCTN] KEY

The HP-IB programming command is shown in parenthesis following the key or softkey.

The [MKR FCTN] (MENUMRKF) key activates a marker if one is not already active, and provides access to additional marker functions. These can be used to quickly change the measurement parameters, to search the trace for specified information, and to analyze the trace statistically.

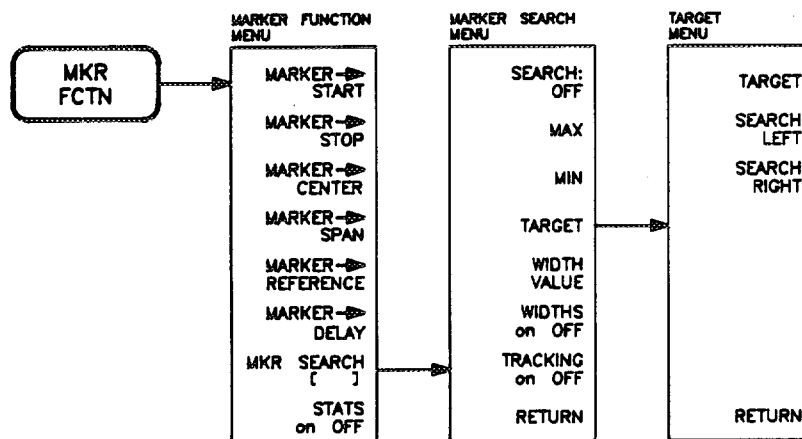

Figure 6-9. Menus Accessed from the [MKR FCTN] Key

Marker Function Menu

This menu provides softkeys that use markers to quickly modify certain measurement parameters without going through the usual key sequence. In addition, it provides access to two additional menus used for searching the trace and for statistical analysis.

The [MARKER →] functions change certain stimulus and response parameters to make them equal to the current active marker value. Use the knob or the numeric keypad to move the marker to the desired position on the trace, and press the appropriate softkey to set the specified parameter to that trace value. When the values have been changed, the marker can again be moved within the range of the new parameters.

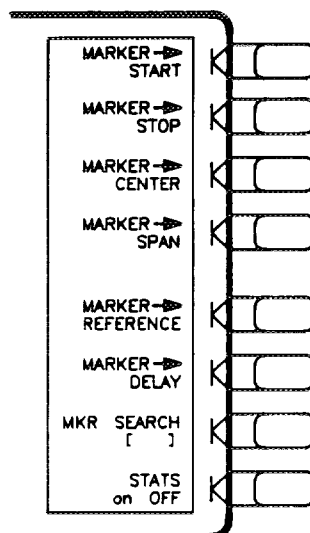

Figure 6-10. Marker Function Menu

[MARKER → START] (MARKSTAR) changes the stimulus start value to the stimulus value of the active marker.

[MARKER → STOP] (MARKSTOP) changes the stimulus stop value to the stimulus value of the active marker.

[MARKER → CENTER] (MARKCENT) changes the stimulus center value to the stimulus value of the active marker, and centers the new span about that value.

[MARKER → SPAN] (MARKSPAN) changes the start and stop values of the stimulus span to the values of the active marker and the delta reference marker. If there is no reference marker, the message "NO MARKER DELTA – SPAN NOT SET" is displayed.

[MARKER → REFERENCE] (MARKREF) makes the reference value equal to the active marker's response value, without changing the reference position. In a polar or Smith chart format, the full scale value at the outer circle is changed to the active marker response value. This softkey also appears in the scale reference menu.

[MARKER → DELAY] (MARKDELA) adjusts the electrical delay to balance the phase of the DUT. This is performed automatically, regardless of the format and the measurement being made. Enough line length is added to or subtracted from the receiver input to compensate for the phase slope at the active marker position. This effectively flattens the phase trace around the active marker, and can be used to measure electrical length or deviation from linear phase. Additional electrical delay adjustments are required on DUTs without constant group delay over the measured frequency span. Since this feature adds phase to a variation in phase versus frequency, it is applicable only for ratioed inputs. This softkey also appears in the scale reference menu.

NOTE: A new marker function, **[MARKER → CW]**, is available in the test sequence function softkey menus described in Chapter 13. This feature is intended for use in automated compression measurements. Test sequences allow the instrument to automatically find a maximum or minimum point on a response trace. The **[MARKER → CW]** command sets the instrument to the CW frequency of the active marker. When power sweep is engaged, the CW frequency will already be selected.

[MARKER SEARCH] leads to the marker search menu, which is used to search the trace for a particular value or bandwidth.

[STATS on OFF] (MEASTATON, MEASTATOFF) calculates and displays the mean, standard deviation, and peak-to-peak values of the section of the displayed trace between the active marker and the delta reference marker. If there is no delta reference, the statistics are calculated for the entire trace. A convenient use of this feature is to find the peak-to-peak value of passband ripple without searching separately for the maximum and minimum values.

The statistics are absolute values: the delta marker here serves to define the span. For polar and Smith chart formats the statistics are calculated using the first value of the complex pair (magnitude, real part, resistance, or conductance).

Marker Search Menu

This menu is used to search the trace for a specific amplitude-related point, and place the marker on that point. The capability of searching for a specified bandwidth is also provided. Tracking is available for a continuous sweep-to-sweep search. If there is no occurrence of a specified value or bandwidth, the message "TARGET VALUE NOT FOUND" is displayed.

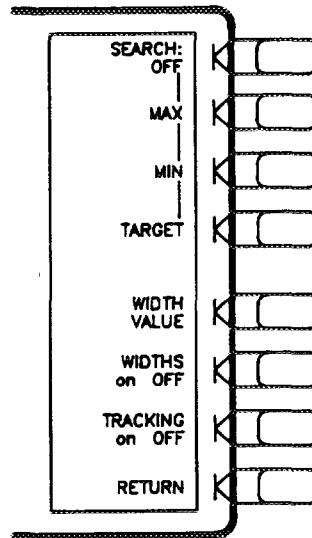

Figure 6-11. Marker Search Menu

[SEARCH: OFF] (SEAOFF) turns off the marker search function.

[MAX] (SEAMAX) moves the active marker to the maximum point on the trace.

[MIN] (SEAMIN) moves the active marker to the minimum point on the trace.

[TARGET] (SEATARG) makes target value the active function, and places the active marker at a specified target point on the trace. The default target value is -3 dB. The target menu is presented, providing search right and search left options to resolve multiple solutions.

For relative measurements, a search reference must be defined with a delta marker or a fixed marker before the search is activated.

[WIDTH VALUE] (WIDV) is used to set the amplitude parameter (for example 3 dB) that defines the start and stop points for a bandwidth search. The bandwidth search feature analyzes a bandpass or band reject trace and calculates the center point, bandwidth, and Q (quality factor) for the specified bandwidth. Bandwidth units are the units of the current format.

[WIDTHS on OFF] (WIDTON, WIDTOFF) turns on the bandwidth search feature and calculates the center stimulus value, bandwidth, and Q of a bandpass or band reject shape on the trace. The amplitude value that defines the passband or rejectband is set using the **[WIDTH VALUE]** softkey.

All four markers are turned on, and each has a dedicated use. Marker 1 is a starting point from which the search is begun. Marker 2 goes to the bandwidth center point. Marker 3 goes to the bandwidth cutoff point on the left, and marker 4 to the cutoff point on the right.

If a delta marker or fixed marker is on, it is used as the reference point from which the bandwidth amplitude is measured. For example, if marker 1 is the delta marker and is set at the passband maximum, and the width value is set to -3 dB, the bandwidth search finds the bandwidth cutoff points 3 dB below the maximum and calculates the 3 dB bandwidth and Q.

If marker 2 (the dedicated bandwidth center point marker) is the delta reference marker, the search finds the points 3 dB down from the center.

If no delta reference marker is set, the bandwidth values are absolute values.

[TRACKING on OFF] (TRACKON, TRACKOFF) is used in conjunction with other search features to track the search with each new sweep. Turning tracking on makes the analyzer search every new trace for the specified target value and put the active marker on that point. If bandwidth search is on, tracking searches every new trace for the specified bandwidth, and repositions the dedicated bandwidth markers.

When tracking is off, the target is found on the current sweep and remains at the same stimulus value regardless of changes in trace response value with subsequent sweeps.

A maximum and a minimum point can be tracked simultaneously using two channels and uncoupled markers.

[RETURN] goes back to the marker function menu.

Target Menu

The target menu places the marker at a specified target response value on the trace, and provides search right and search left options. If there is no occurrence of the specified value, the message "TARGET VALUE NOT FOUND" is displayed.

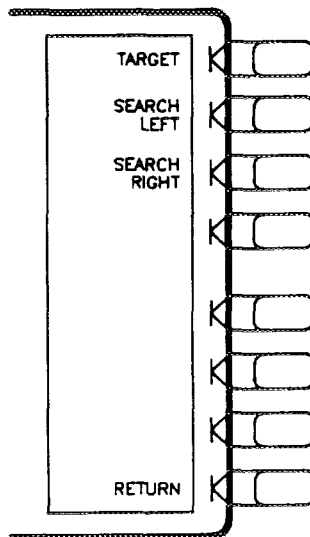

Figure 6-12. Target Menu

[TARGET] (SEATARG) places the marker at the specified target response value. If tracking is on (see previous menu) the target is automatically tracked with each new trace. If tracking is off, the target is found each time this key is pressed. The target value is in units appropriate to the current format. The default target value is -3 dB.

In delta marker mode, the target value is the value relative to the reference marker. If no delta reference marker is on, the target value is an absolute value.

[SEARCH LEFT] (SEAL) searches the trace for the next occurrence of the target value to the left.

[SEARCH RIGHT] (SEAR) searches the trace for the next occurrence of the target value to the right.

[RETURN] goes back to the marker search menu.



Chapter 7. Instrument State Function Block

CHAPTER CONTENTS

- 7-1 Introduction
- 7-2 Instrument State Functions and Where They Are Described
- 7-2 [LOCAL] Key
- 7-3 HP-IB Menu
- 7-5 Address Menu
- 7-7 [SYSTEM] Key
- 7-8 Limit Lines and Limit Testing
- 7-10 Limits Menu
- 7-12 Edit Limits Menu
- 7-13 Edit Segment Menu
- 7-15 Limit Type Menu
- 7-16 Offset Limits Menu

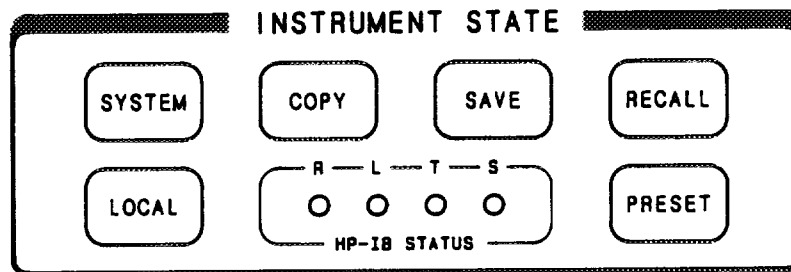

Figure 7-1. Instrument State Function Block

INTRODUCTION

The instrument state function block keys and associated menus provide control of channel-independent system functions. These include instrument modes, sequencing, controller modes, instrument addresses, HP-IB status information, plotting or printing, and saving instrument states either in internal memory or on an external disc.

INSTRUMENT STATE FUNCTIONS AND WHERE THEY ARE DESCRIBED

Functions accessible in the instrument state function block are described in several different chapters of this *Reference*, and in portions of the *On-Site System Service Manual*.

Table 7-1 lists each function and where it is discussed. Unless otherwise noted, all references are in this *Reference* and are marked with the acronym "REF".

Table 7-1. Instrument State Function Descriptions

Instrument State Key	Function	Chapter or Manual
[SYSTEM]	6 GHz Operation (option 006) Test Sequence Function Limit Lines and Limit Testing Time Domain Transform Harmonic Measurements External Source Mode Tuned Receiver Mode Frequency Offset Operation Service Menu	Chapter 14, REF Chapter 13, REF This Chapter Chapter 8, REF Chapter 14, REF Chapter 14, REF Chapter 14, REF Chapter 14, REF <i>On-Site System Service Manual</i>
[COPY]	All Features – including printing and plotting	Chapter 9, REF
[SAVE]	All Features – including saving instrument states and saving to external disk.	Chapter 10, REF
[RECALL]	All Features – including recall of instrument state, and recall from external disk drive.	Chapter 10, REF
[LOCAL]	All Features – including HP-IB and address menus.	This Chapter
[PRESET]	Preset State	Appendix A, REF

[LOCAL KEY]

The HP-IB programming command is shown in parenthesis following the key or softkey.

This key is used to return the analyzer to local (front panel) operation from remote (computer controlled) operation. This key will also abort a test sequence or hardcopy print/plot. In this local mode, with a controller still connected on HP-IB, the analyzer can be operated manually (locally) from the front panel. This is the only front panel key that is not disabled when the analyzer is remotely controlled over HP-IB by a computer. The exception to this is when local lockout is in effect: this is a remote command that disables the [LOCAL] key, making it difficult to interfere with the analyzer while it is under computer control.

In addition, this key gives access to the HP-IB menu, which sets the controller mode, and to the address menu, where the HP-IB addresses of peripheral devices are entered.

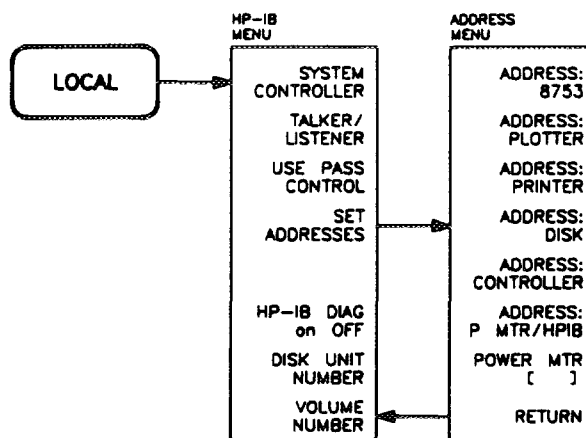

Figure 7-2. Softkey Menus Accessed from the [LOCAL] Key

HP-IB Menu

The analyzer is factory-equipped with a remote programming interface using the Hewlett-Packard Interface Bus (HP-IB). This enables communication between the analyzer and a controlling computer as well as other peripheral devices. This menu indicates the present HP-IB controller mode of the analyzer. Three HP-IB modes are possible: system controller, talker/listener, and pass control.

Talker/listener is the mode of operation most often used. In this mode, a computer controller communicates with the analyzer and other compatible peripherals over the bus. The computer sends commands or instructions to and receives data from the analyzer. All of the capabilities available from the analyzer front panel can be used in this remote operation mode, except for control of the power line switch and some internal tests.

In the system controller mode, the analyzer itself can use HP-IB to control compatible peripherals, without the use of an external computer. It can output measurement results directly to a compatible printer or plotter, store instrument states using a compatible disk drive, or control a power meter for performing service routines. The power meter calibration function requires system controller or pass control mode.

A third mode of HP-IB operation is the pass control mode. In an automated system with a computer controller, the controller can pass control of the bus to the analyzer on request from the analyzer. The analyzer is then the controller of the peripherals, and can direct them to plot, print, or store without going through the computer. When the peripheral operation is complete, control is passed back to the computer. Only one controller can be active at a time. The computer remains the system controller, and can regain control at any time.

Preset does not affect the selected controller mode, but cycling the power returns the analyzer to talker/listener mode.

Information on compatible peripherals is provided in the *General Information and Specifications* section of this manual.

HP-IB STATUS Indicators. When the analyzer is connected to other instruments over HP-IB, the HP-IB STATUS indicators in the instrument state function block light up to display the current status of the analyzer.

- R = Remote operation.
- L = Listen mode.
- T = Talk mode.
- S = Service request (SRQ) asserted by the analyzer.

Information on HP-IB operation is provided in Chapter 11.

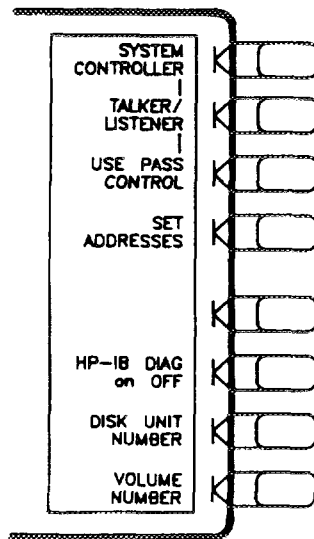

Figure 7-3. HP-IB Menu

[SYSTEM CONTROLLER] is the mode used when peripheral devices are to be used and there is no external controller. In this mode, the analyzer can directly control peripherals (plotter, printer, disk drive, or power meter). System controller mode must be set in order for the analyzer to access peripherals from the front panel to plot, print, store on disk, or perform power meter functions, if there is no other controller on the bus.

The system controller mode can be used without knowledge of HP-IB programming. However, the HP-IB address must be entered for each peripheral device.

This mode can only be selected manually from the analyzer's front panel, and can be used only if no active computer controller is connected to the system through HP-IB. If you try to set system controller mode when another controller is present, the message "CAUTION: CAN'T CHANGE - ANOTHER CONTROLLER ON BUS" is displayed. Do not attempt to use this mode for programming.

[TALKER/LISTENER] (TALKLIST) is the mode normally used for remote programming of the analyzer. In this mode, the analyzer and all peripheral devices are controlled from the external controller. The controller can command the analyzer to talk, and the plotter or other device to listen. The analyzer and peripheral devices cannot talk directly to each other unless the computer sets up a data path between them.

This mode allows the analyzer to be either a talker or a listener, as required by the controlling computer for the particular operation in progress.

A talker is a device capable of sending out data when it is addressed to talk. There can be only one talker at any given time. The analyzer is a talker when it sends information over the bus.

A listener is a device capable of receiving data when it is addressed to listen. There can be any number of listeners at any given time. The analyzer is a listener when it is controlled over the bus by a computer.

[USE PASS CONTROL] (USEPASC) lets you control the analyzer with the computer over HP-IB as with the talker/listener mode, and also allows the analyzer to become a controller in order to plot, print, or directly access an external disk. During this peripheral operation, the host computer is free to perform other internal tasks that do not require use of the bus (the bus is tied up by the network analyzer during this time).

The pass control mode requires that the external controller is programmed to respond to a request for control and to issue a take control command. When the peripheral operation is complete, the analyzer passes control back to the computer. Refer to the *HP-IB Programming Guide* for more information.

In general, use the talker/listener mode for programming the analyzer unless direct peripheral access is required.

[SET ADDRESSES] goes to the address menu, which is used to set the HP-IB address of the analyzer, and to display and modify the addresses of peripheral devices in the system.

[HP-IB DIAG on off] (DEBUON, DEBUOFF) toggles the HP-IB diagnostic feature (debug mode). This mode should only be used the first time a program is written: if a program has already been debugged, it is unnecessary.

When diagnostics are on, the analyzer scrolls a history of incoming HP-IB commands across the display in the title line. Nonprintable characters are represented as π . If a syntax error is received, the commands halt and a pointer \wedge indicates the misunderstood character. To clear a syntax error, refer to the *HP-IB Programming Guide*.

[DISC UNIT NUMBER] (DISCUNIT) specifies the number of the disk unit in the disk drive that is to be accessed in an external disk store or load routine. This is used in conjunction with the HP-IB address of the disk drive, and the volume number, to gain access to a specific area on a disk. The access hierarchy is HP-IB address, disk unit number, disk volume number. More information on storing information to an external disk is provided in Chapter 10, *Saving Instrument States*.

[VOLUME NUMBER] (DISCVOLU) specifies the number of the disk volume to be accessed. In general, all 3.5 inch floppy disks are considered one volume (volume 0). For hard disk drives, such as the HP 9153A (Winchester), a switch in the disk drive must be set to define the number of volumes on the disk. For more information, refer to the manual for the individual hard disk drive.

Address Menu

In communications through the Hewlett-Packard Interface Bus (HP-IB), each instrument on the bus is identified by an HP-IB address. This decimal-based address code must be different for each instrument on the bus.

This menu sets the HP-IB address of the analyzer, and to enter the addresses of peripheral devices so that the analyzer can communicate with them.

Most of the HP-IB addresses are set at the factory and need not be modified for normal system operation. The standard factory-set addresses for instruments that may be part of the system are as follows:

Instrument	HP-IB Address (decimal)
analyzer	16
Plotter	05
Printer	01
External Disk Drive	00
Controller	21
Power Meter	13

The address displayed in this menu for each peripheral device must match the address set on the device itself. If the addresses do not match, they can be matched in one of two ways. Either the address in the analyzer softkey label for the device can be modified using the entry controls; or the address of the device can be changed using instructions provided in the device's manual. The analyzer does not have an HP-IB switch: its address is set only from the front panel.

These addresses are stored in short-term, non-volatile memory and are not affected by preset or by cycling the power.

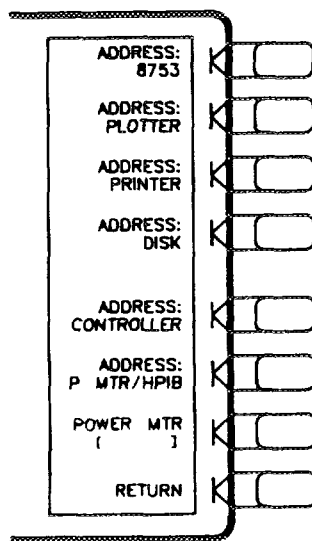

Figure 7-4. Address Menu

[ADDRESS: 8753] sets the HP-IB address of the analyzer, using the entry controls. There is no physical address switch to set in the analyzer.

[ADDRESS: PLOTTER] (ADDRPLOT) sets the HP-IB address the analyzer will use to communicate with the plotter.

[ADDRESS: PRINTER] (ADDRPRIN) sets the HP-IB address the analyzer will use to communicate with the printer.

[ADDRESS: DISK] (ADDRDISC) sets the HP-IB address the analyzer will use to communicate with the disk drive.

[ADDRESS: CONTROLLER] (ADDRCONT) sets the HP-IB address the analyzer will use to communicate with the external controller.

[ADDRESS: P MTR/HPIB] (ADDRPOWM) sets the HP-IB address the analyzer will use to communicate with the power meter used in service routines.

[POWER MTR] (POWM) toggles between **[436A]** or **[438A/437]**. These power meters are HP-IB compatible with the analyzer. The model number in the softkey label must match the power meter to be used.

[RETURN] goes back to the HP-IB menu.

[SYSTEM] KEY (MENUSYST)

The HP-IB programming command is shown in parenthesis following the key or softkey.

This key presents the system menu.

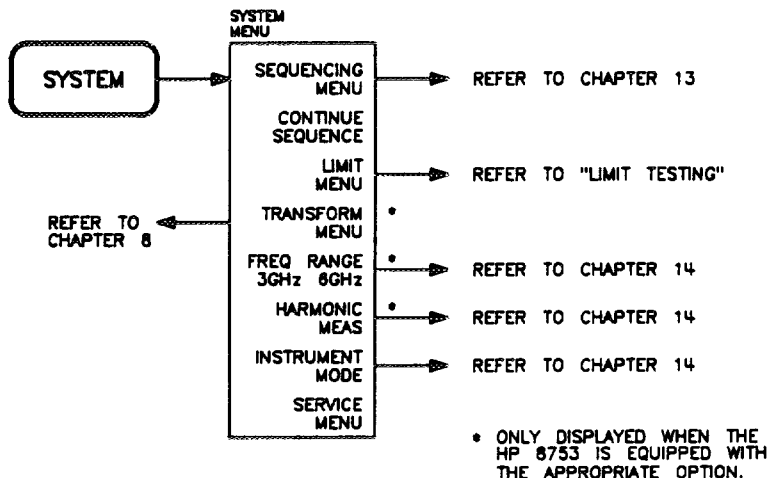

Figure 7-5. The System Menu

[SEQUENCING MENU] leads to the test sequence function menus. Sequencing allows the operator to define a series of test keystrokes which may then be run automatically. This function is described in Chapter 13.

[LIMIT MENU] leads to a series of menus used to define limits or specifications with which to compare a test device. Refer to *Limit Lines and Limit Testing*.

[TRANSFORM MENU] (option 010) leads to a series of menus that transform the measured data from the frequency domain to the time domain. Time domain modes and features are explained in Chapter 8, *Time and Frequency Domain Transforms*. This softkey is present only in analyzer's purchased with option 010.

[FREQ RANGE 3GHz6GHz] (option 006) only appears on the menu if an HP 85047A 6 GHz test set is connected to the analyzer. This softkey toggles the system between a maximum frequency of 3 and 6 GHz. Refer to Chapter 14.

[HARMONIC MEASUREMENTS] (option 002 only) leads to the harmonics menu. This feature phase locks to the 2nd or 3rd harmonic of the fundamental signal. Measured harmonics can not exceed the frequency range of the analyzer receiver. Refer to Chapter 14.

[INSTRUMENT MODE] presents the instrument mode menu. This provides access to the primary modes of operation (analyzer modes), each of which is described fully in Chapter 14. The following is a list of available instrument (analyzer) modes:

- **Network Analyzer.** This is the "normal" operating mode.
- **External Source Auto.** This allows the analyzer to phase lock to an external CW signal. This feature works only in CW time sweep type. The external source auto mode searches for the incoming CW signal. The search range is $\pm 10\%$ of the selected CW frequency (± 5 MHz below 50 MHz). The manual mode does not have this search capability, and the incoming signal must be within -0.5 to $+5.0$ MHz of the entered frequency value. The manual mode is faster than the auto mode.

The external source should not exhibit noise or significant sidebands, as the analyzer may phase-lock onto a spur instead of the fundamental.

- **External Source Manual.** This allows the analyzer to phase lock to an external CW signal. This feature works only in CW time sweep type. The incoming signal should not have large spurs or sidebands for the reason explained above. This mode is faster than the auto mode, but it does not search for the incoming signal. The frequency of the incoming signal should be within -0.5 to $+5.0$ MHz of the selected frequency or the analyzer will not be able to phase lock to it.
- **Tuned Receiver.** In this mode the receiver operates independently of any source. All phase lock routines are bypassed, increasing sweep speed significantly. This function only works in CW time sweep. The external source must be synthesized and drive the analyzer's external frequency reference. Refer to Chapter 14.

In Addition to the above instrument modes, frequency offset operation is available under the **[INSTRUMENT MODE]** softkey. Frequency offset is a feature of the network analyzer mode, it is not an instrument mode itself. The analyzer must be in network analyzer mode before frequency offset can be turned on.

- **Frequency Offset.** This allows phase locked operation with a frequency offset between the internal source and receiver. In a typical mixer application; the internal source is input to the mixer's RF input, an external source is input to the mixer's LO input, and the resultant IF signal is input to the receiver. The upper frequency limit of this function is 3 GHz. When using frequency offset mode, the frequency of the internal source must be greater than the LO frequency. Both of these frequencies must be greater than the IF used for phase-locking.

[SERVICE MENU] leads to a series of service menus described in detail in the *On-Site System Service Manual*.

LIMIT LINES AND LIMIT TESTING

Limit lines are lines drawn on the CRT to represent upper and lower limits or device specifications with which to compare the device under test. Limits are defined in segments, where each segment is a portion of the stimulus span. Each limit segment has an upper and a lower starting limit value. Three types of segments are available: flat line, sloping line, and single point.

Limits can be defined independently for the two channels, up to 18 segments for each channel (a total of 36 for both channels). These can be in any combination of the three limit types.

Limit testing compares the measured data with the defined limits, and provides pass or fail information for each measured data point. An out-of-limit test condition is indicated in five ways: with a FAIL message on the screen, with a beep, by blanking of portions of the trace, with an asterisk in tabular listings of data, and with a bit in the HP-IB event status register B. An HP 85047A test set has a BNC output that includes this status.

Limit lines and limit testing can be used simultaneously or independently. If limit lines are on and limit testing is off, the limit lines are displayed on the CRT for visual comparison and adjustment of the measurement trace. However, no pass/fail information is provided. If limit testing is on and limit lines are off, the specified limits are still valid and the pass/fail status is indicated even though the limit lines are not displayed on the CRT.

Limits are entered in tabular form. Limit lines and limit testing can be either on or off while limits are defined. As new limits are entered, the tabular columns on the CRT are updated, and the limit lines (if on) are modified to the new definitions. The complete limit set can be offset in either stimulus or amplitude value.

Limits are checked only at the actual measured data points. It is possible for a device to be out of specification without a limit test failure indication if the point density is insufficient. Be sure to specify a high enough number of measurement points in the stimulus menu.

Limit lines are displayed only on Cartesian formats. In polar and Smith chart formats, limit testing of one value is available: the value tested depends on the marker mode and is the magnitude or the first value in a complex pair. The message "NO LIMIT LINES DISPLAYED" is shown on the CRT in polar and Smith chart formats.

The list values feature in the copy menu provides tabular listings to the CRT or a printer for every measured stimulus value. These include limit line or limit test information if these functions are turned on. If limit testing is on, an asterisk * is listed next to any measured value that is out of limits. If limit lines are on, and other listed data allows sufficient space, the upper limit and lower limit are listed, together with the margin by which the device data passes or fails the nearest limit. For more information about the list values feature, refer to Chapter 9, *Making a Hard Copy Output*.

If limit lines are on, they are plotted with the data on a plot. If limit testing is on, the PASS or FAIL message is plotted, and the failing portions of the trace that are blanked on the CRT are also blanked on the plot. If limits are specified, they are saved in memory with an instrument state.

An example of a measurement using limit lines and limit testing is provided in the *User's Guide*.

The series of menus for defining limits is accessed from the [SYSTEM] key. These menus are illustrated in Figure 7-6.

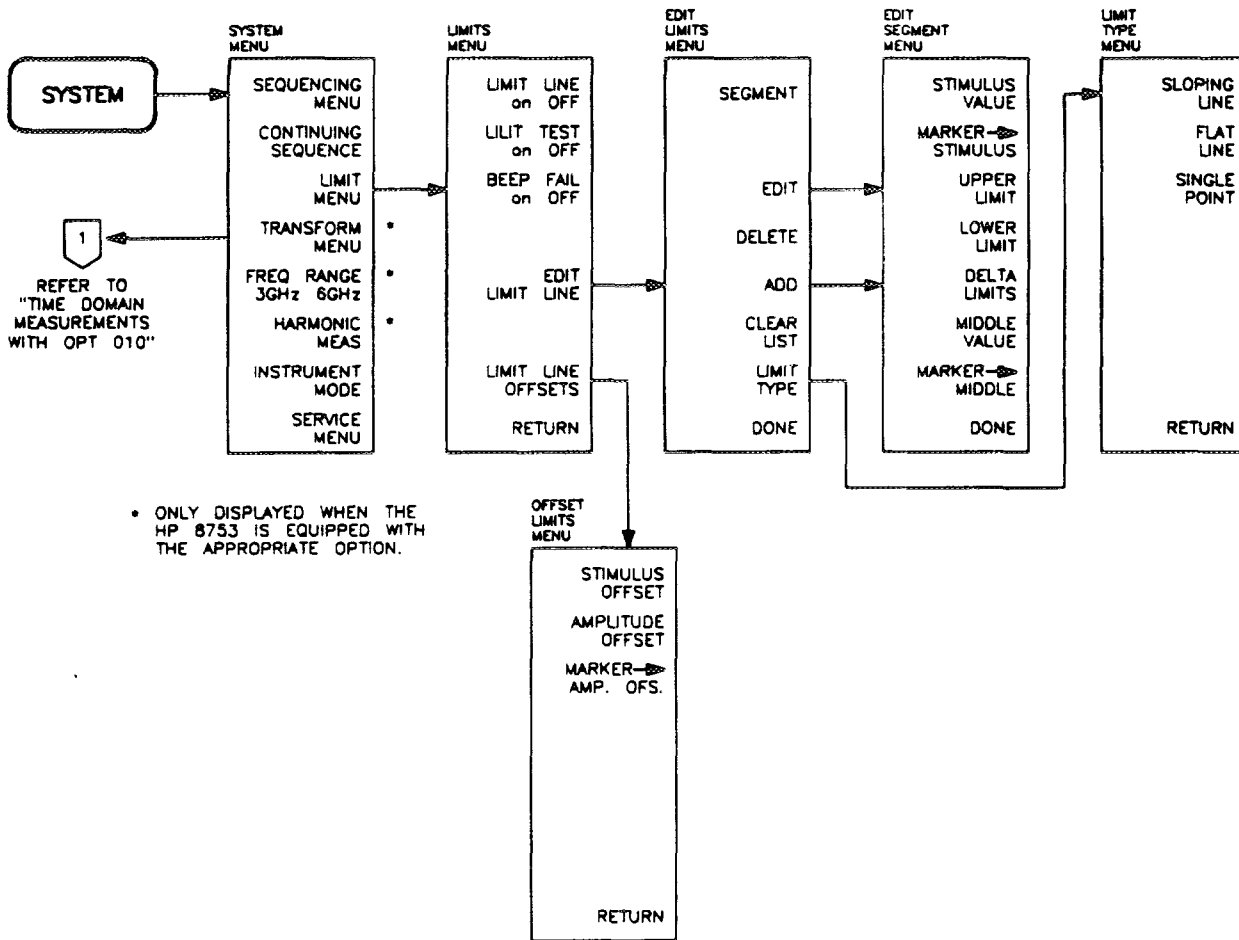

Figure 7-6. Softkey Menus Access from the [LIMIT MENU] softkey.

Limits Menu

This menu independently toggles the limit lines, limit testing, and limit fail beeper. In addition, it leads to the menus used to define and modify the limits.

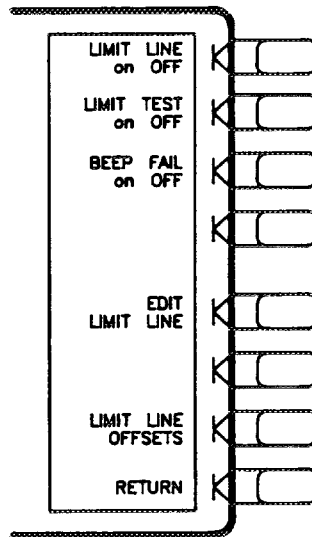

Figure 7-7. Limits Menu

[LIMIT LINE on OFF] (LIMILINEON, LIMILINEOFF) turns limit lines on or off. To define limits, use the **[EDIT LIMIT LINE]** softkey described below. If limits have been defined and limit lines are turned on, the limit lines are displayed on the CRT for visual comparison of the measured data in all Cartesian formats.

If limit lines are on, they are plotted with the data on a plot, and saved in memory with an instrument state. In a listing of values from the copy menu with limit lines on, the upper limit and lower limit are listed together with the pass or fail margin, as long as other listed data allows sufficient space.

[LIMIT TEST on OFF] (LIMITESTON, LIMITESTOFF) turns limit testing on or off. When limit testing is on, the data is compared with the defined limits at each measured point. Limit tests occur at the end of each sweep, whenever the data is updated, when formatted data is changed, and when limit testing is first turned on.

Limit testing is available for both magnitude and phase values in Cartesian formats. In polar and Smith chart formats, the value tested depends on the marker mode and is the magnitude or the first value in a complex pair. The message "NO LIMIT LINES DISPLAYED" is displayed in polar and Smith chart formats if limit lines are turned on.

Five indications of pass or fail status are provided when limit testing is on. A PASS or FAIL message is displayed at the right of the CRT. The trace vector leading to any measured point that is out of limits is blanked at the end of every limit test, both on a CRT plot and a hard copy plot. The limit fail beeper sounds if it is turned on. In a listing of values using the copy menu, an asterisk * is shown next to any measured point that is out of limits. A bit is set in the HP-IB status byte.

[BEEP FAIL on OFF] (BEEPFAILON, BEEPFAILOFF) turns the limit fail beeper on or off. When limit testing is on and the fail beeper is on, a beep is sounded each time a limit test is performed and a failure detected. The limit fail beeper is independent of the warning beeper and the operation complete beeper, both of which are in the display more menu (Chapter 4).

[EDIT LIMIT LINE] (EDITLIML) displays a table of limit segments on the CRT, superimposed on the trace. The edit limits menu is presented so that limits can be defined or changed. It is not necessary for limit lines or limit testing to be on while limits are defined.

[LIMIT LINE OFFSETS] leads to the offset limits menu, which is used to offset the complete limit set in either stimulus or amplitude value.

[RETURN] goes back to the system menu.

Edit Limits Menu

This menu is used to specify limits for limit lines or limit testing, and presents a table of limit values on the CRT. Limits are defined in segments. Each segment is a portion of the stimulus span. Up to 18 limit segments can be specified for each channel (a total of 36 for both channels). The limit segments do not have to be entered in any particular order: the analyzer automatically sorts them and lists them on the CRT in increasing order of start stimulus value.

For each segment, the table lists the segment number, the starting stimulus value, upper limit, lower limit, and limit type. The ending stimulus value is the start value of the next segment, or a segment can be terminated with a single point segment. Limit values are entered as upper and lower limits or delta limits and middle value. As new limit segments are defined the tabular listing is updated, and if limit lines are switched on they are plotted on the CRT.

If no limits have been defined, the table of limit values shows the notation "EMPTY." Limit segments are added to the table using the **[ADD]** softkey or edited with the **[EDIT]** softkey, as described below. The last segment on the list is followed by the notation "END."

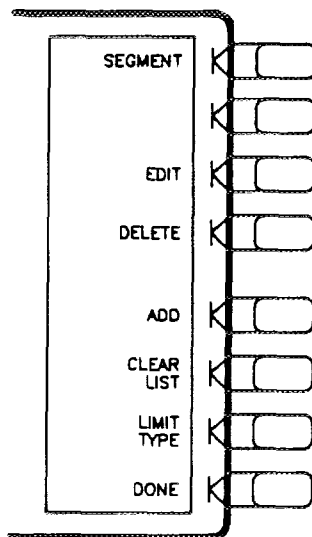

Figure 7-8. Edit Limits Menu

[SEGMENT] specifies which limit segment in the table is to be modified. A maximum of three sets of segment values are displayed at one time, and the list can be scrolled up or down to show other segment entries. Use the entry block controls to move the pointer > to the required segment number. The indicated segment can then be edited or deleted. If the table of limits is designated "EMPTY," new segments can be added using the **[ADD]** or **[EDIT]** softkey.

[EDIT] (SEDI) displays the edit segment menu, which is used to define or modify the stimulus value and limit values of a specified segment. If the table was empty, a default segment is displayed. The default segment is a sloping line with zero limits and stimulus values that vary according to the current stimulus mode (frequency, power, or time).

[DELETE] (SDEL) deletes the limit segment indicated by the pointer >.

[ADD] (SADD) displays the edit segment menu and adds a new segment to the end of the list. The new segment is initially a duplicate of the segment indicated by the pointer > and selected with the **[SEGMENT]** softkey. If the table was empty, a default segment is displayed, as described under **[EDIT]** above.

[CLEAR LIST] (CLEL) Clears all of the segments in the limit test.

[LIMIT TYPE] leads to the limit type menu, where one of three segment types can be selected.

[DONE] (EDITDONE) sorts the limit segments and displays them on the CRT in increasing order of stimulus value. The limits menu is returned to the screen.

Edit Segment Menu

This menu sets the values of the individual limit segments. The segment to be modified, or a default segment, is selected in the edit limits menu. The stimulus value can be set with the controls in the entry block or with a marker (the marker is turned on automatically when this menu is presented). The limit values can be defined as upper and lower limits, or delta limits and middle value. Both an upper limit and a lower limit (or delta limits) must be defined: if only one limit is required for a particular measurement, force the other out of range (for example +500 dB or -500 dB).

As new values are entered, the tabular listing of limit values is updated.

Segments do not have to be listed in any particular order: the analyzer sorts them automatically in increasing order of start stimulus value when the **[DONE]** key in the edit limits menu is pressed. However, the easiest way to enter a set of limits is to start with the lowest stimulus value and define the segments from left to right of the display, with limit lines turned on as a visual check.

Phase limit values can be specified between +500° and -500°. Limit values above +180° and below -180° are mapped into the range of -180° to +180° to correspond with the range of phase data values.

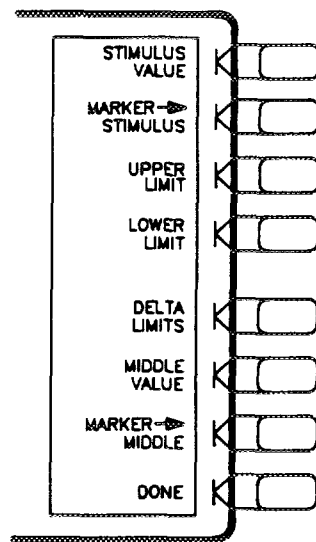

Figure 7-9. Edit Segment Menu

[STIMULUS VALUE] (LIMS) sets the starting stimulus value of a segment, using entry block controls. The ending stimulus value of the segment is defined by the start of the next line segment. No more than one segment can be defined over the same stimulus range.

[MARKER → STIMULUS] (MARKSTIM) sets the starting stimulus value of a segment using the active marker. Move the marker to the desired starting stimulus value before pressing this key, and the marker stimulus value is entered as the segment start value.

[UPPER LIMIT] (LIMU) sets the upper limit value for the start of the segment. If a lower limit is specified, an upper limit must also be defined. If no upper limit is required for a particular measurement, force the upper limit value out of range (for example +500 dB).

When **[UPPER LIMIT]** or **[LOWER LIMIT]** is pressed, all the segments in the table are displayed in terms of upper and lower limits, even if they were defined as delta limits and middle value.

If you attempt to set an upper limit that is lower than the lower limit, or vice versa, both limits will be automatically set to the same value.

[LOWER LIMIT] (LIML) sets the lower limit value for the start of the segment. If an upper limit is specified, a lower limit must also be defined. If no lower limit is required for a particular measurement, force the lower limit value out of range (for example -500 dB).

[DELTA LIMITS] (LIMD) sets the limits an equal amount above and below a specified middle value, instead of setting upper and lower limits separately. This is used in conjunction with **[MIDDLE VALUE]** or **[MARKER → MIDDLE]**, to set limits for testing a device that is specified at a particular value plus or minus an equal tolerance.

For example, a device may be specified at 0 dB ± 3 dB. Enter the delta limits as 3 dB and the middle value as 0 dB.

When **[DELTA LIMITS]** or **[MIDDLE VALUE]** is pressed, all the segments in the table are displayed in these terms, even if they were defined as upper and lower limits.

[MIDDLE VALUE] (LIMM) sets the midpoint for **[DELTA LIMITS]**. It uses the entry controls to set a specified amplitude value vertically centered between the limits.

[MARKER → MIDDLE] (MARKMIDD) sets the midpoint for **[DELTA LIMITS]** using the active marker to set the middle amplitude value of a limit segment. Move the marker to the desired value or device specification, and press this key to make that value the midpoint of the delta limits. The limits are automatically set an equal amount above and below the marker.

[DONE] (SDON) terminates a limit segment definition, and returns to the edit limits menu.

Limit Type Menu

This menu defines the selected limit segment as a sloping line, a flat line, or a single point.

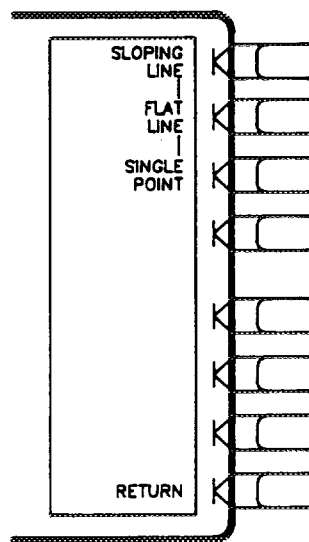

Figure 7-10. Limit Type Menu

[SLOPING LINE] (LIMTSL) defines a sloping limit line segment that is linear with frequency or other stimulus value, and is continuous to the next stimulus value and limit. If a sloping line is the final segment it becomes a flat line terminated at the stop stimulus. A sloping line segment is indicated as SL on the displayed table of limits.

[FLAT LINE] (LIMTFL) defines a flat limit line segment whose value is constant with frequency or other stimulus value. This line is continuous to the next stimulus value, but is not joined to a segment with a different limit value. If a flat line segment is the final segment it terminates at the stop stimulus. A flat line segment is indicated as FL on the table of limits.

[SINGLE POINT] (LIMTSP) sets the limits at a single stimulus point. If limit lines are on, the upper limit value of a single point limit is displayed as ∇ , and the lower limit is displayed as \triangle . A limit test at a single point not terminating a flat or sloped line tests the nearest actual measured data point.

A single point limit can be used as a termination for a flat line or sloping line limit segment. When a single point terminates a sloping line or when it terminates a flat line and has the same limit values as the flat line, the single point is not displayed as ∇ and \triangle . The indication for a sloping line segment in the displayed table of limits is SP.

[RETURN] goes back to the edit limits menu.

Offset Limits Menu

This menu allows the complete limit set to be offset in either stimulus value or amplitude value. This is useful for changing the limits to correspond with a change in the test setup, or for device specifications that differ in stimulus or amplitude. It can also be used to move the limit lines away from the data trace temporarily for visual examination of trace detail.

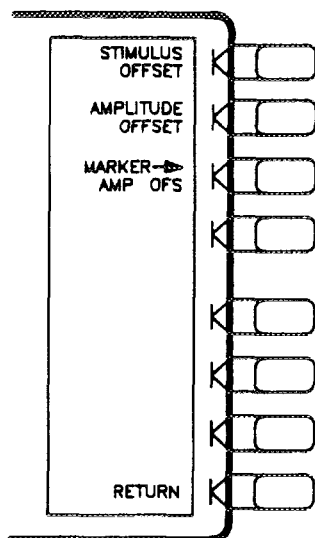

Figure 7-11. Offset Limits Menu

[STIMULUS OFFSET] (LIMISTIO) adds or subtracts an offset in stimulus value. This allows limits already defined to be used for testing in a different stimulus range. Use the entry block controls to specify the offset required.

[AMPLITUDE OFFSET] (LIMIAMPO) adds or subtracts an offset in amplitude value. This allows limits already defined to be used for testing at a different response level. For example, if attenuation is added to or removed from a test setup, the limits can be offset an equal amount. Use the entry block controls to specify the offset.

[MARKER → AMP. OFS.] (LIMIMAOF) uses the active marker to set the amplitude offset. Move the marker to the desired middle value of the limits and press this softkey. The limits are then moved so that they are centered an equal amount above and below the marker at that stimulus value.

[RETURN] goes back to the limits menu.

Chapter 8. Time and Frequency Domain Transforms

CHAPTER CONTENTS

- 8-1 Introduction
- 8-2 General Theory
- 8-3 Time Domain Bandpass
- 8-6 Time Domain Low Pass
- 8-12 Time Domain Concepts
- 8-19 Transforming CW Time Measurements Into The Frequency Domain

INTRODUCTION

With option 010, the analyzer can transform frequency domain data to the time domain or time domain data to the frequency domain. In normal operation, the analyzer measures the characteristics of a device under test (DUT) as a function of frequency. Using a mathematical technique (the inverse Fourier transform), the analyzer transforms frequency domain information into the time domain, with time as the horizontal display axis. Response values (measured on the vertical axis) now appear separated in time or distance, providing valuable insight into the behavior of the DUT beyond simple frequency characteristics.

NOTE: An HP 8753 can be ordered with option 010, or the option can be added at a later date using the HP 85019B time domain retrofit kit.

The transform used by the analyzer resembles time domain reflectometry (TDR) measurements. TDR measurements, however, are made by launching an impulse or step into the DUT and observing the response in time with a receiver similar to an oscilloscope. In contrast, the analyzer makes swept frequency response measurements, and mathematically transforms the data into a TDR-like display.

The analyzer has three frequency-to-time transform modes:

Time Domain Bandpass Mode is designed to measure band-limited devices and is the easiest mode to use. This mode simulates the time domain response to an impulse input.

Time Domain Low Pass Step Mode simulates the time domain response to a step input. As in a traditional TDR measurement, the distance to the discontinuity in the DUT, and the type of discontinuity (resistive, capacitive, inductive) can be determined.

Time Domain Low Pass Impulse Mode simulates the time domain response to an impulse input (like the bandpass mode). Both low pass modes yield better time domain resolution for a given frequency span than does the bandpass mode. In addition, using the low pass modes you can determine the type of discontinuity. However, these modes have certain limitations that are defined in the low pass section of this chapter.

The analyzer has one time-to-frequency transform mode:

Forward Transform Mode transforms CW signals measured over time into the frequency domain, to measure the spectral content of a signal. This mode is known as the CW time mode.

In addition to these transform modes, this chapter discusses special transform concepts such as masking, windowing, and gating.

GENERAL THEORY

The relationship between the frequency domain response and the time domain response of the analyzer is defined by the Fourier transform. Because of this transform, it is possible to measure, in the frequency domain, the response of a linear DUT and mathematically calculate the inverse Fourier transform of the data to find the time domain response. The analyzer's internal computer makes this calculation using the chirp-Z Fourier transform technique. The resulting measurement is the fully error-corrected time domain reflection or transmission response of the DUT, displayed in near real time.

Table 8-1 lists the useful formats for time domain reflection measurements. Time domain transmission measurements are displayed using the linear magnitude or log magnitude formats, as described later in this chapter.

Table 8-1. Time Domain Reflection Formats

Format	Parameter
LIN MAG	Reflection Coefficient (unitless) ($0 < \rho < 1$)
REAL	Reflection Coefficient (unitless) ($-1 < \rho < 1$)
LOG MAG	Return Loss (dB)
SWR	Standing Wave Ratio (unitless)

Figure 8-1 illustrates the frequency and time domain reflection responses of a device. The frequency domain reflection measurement is the composite of all the signals reflected by the discontinuities present in the DUT over the measured frequency range.

NOTE: In this chapter, all points of reflection are referred to as discontinuities.

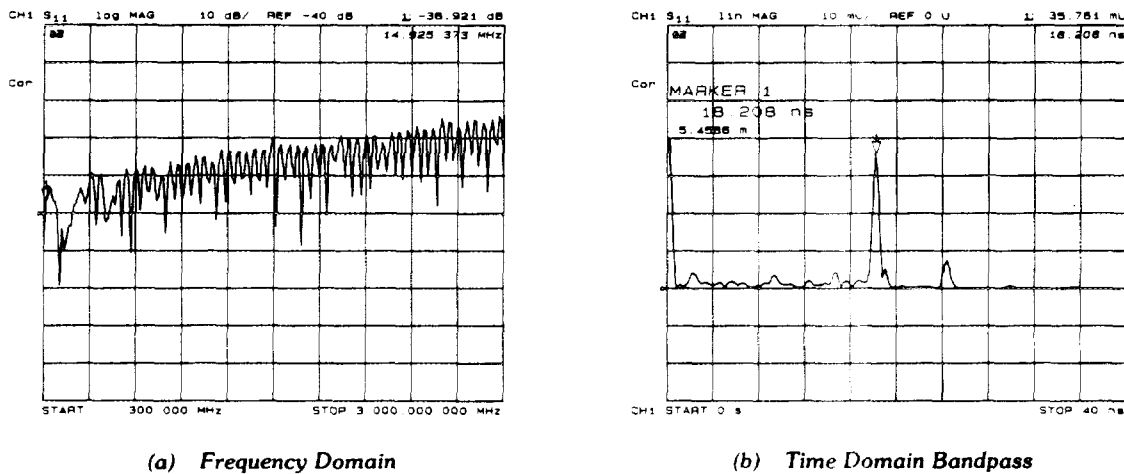
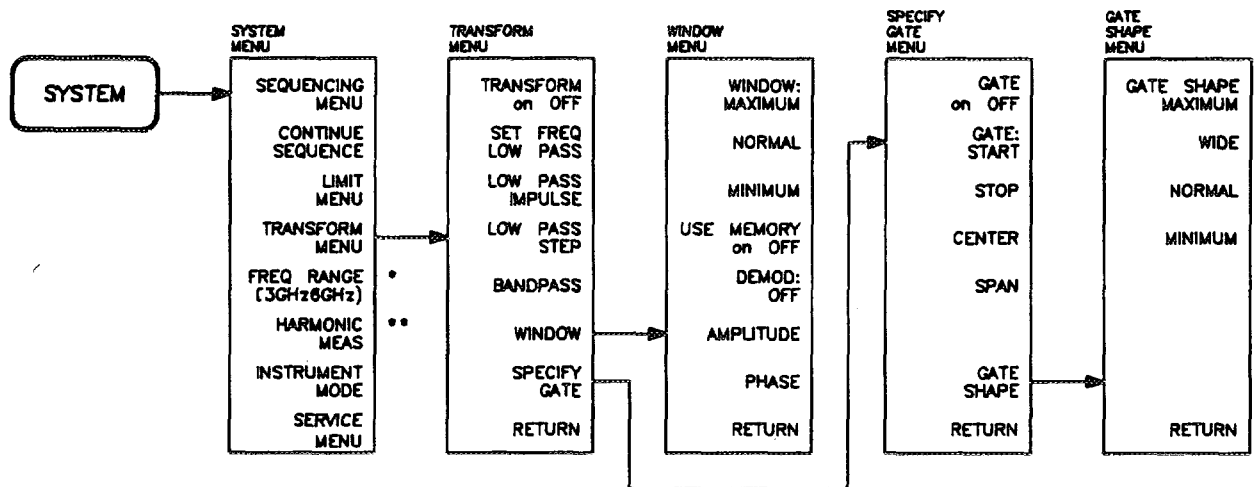

Figure 8-1. Device Frequency Domain and Time Domain Reflection Responses

The time domain measurement shows the effect of each discontinuity as a function of time (or distance), and shows that the device response consists of three separate impedance changes. The second discontinuity has a reflection coefficient magnitude of 0.035 (i.e. 3.5% of the incident signal is reflected). Marker 1 on the time domain trace shows the round-trip time to the discontinuity and back to the reference plane (where the calibration standards are connected): 18.2 nanoseconds. The distance shown (5.45 metres) assumes that the signal travels at the speed of light. The signal travels slower than the speed of light in most media (e.g. coax cables). This slower velocity (relative to light) can be compensated for by adjusting the analyzer relative velocity factor. This procedure is described later in this chapter.

Figure 8-2 illustrates the transform menus, which are accessed from the [SYSTEM] key.



* Displayed only in instruments equipped with option 006.
 **Displayed only in instruments equipped with option 002.

Figure 8-2. The Time Domain Transform Menus

TIME DOMAIN BANDPASS

This mode is called bandpass because it works with band-limited devices. Traditional TDR requires that the DUT be able to operate down to DC. Using bandpass mode, there are no restrictions on the measurement frequency range. Bandpass mode characterizes the DUT impulse response.

Reflection Measurements Using Bandpass Mode

NOTE: Before making time domain reflection measurements, perform the appropriate calibration.

Example:

1. Press [PRESET]. The default measurement at preset (with an S-parameter test set) is S11 on channel 1.
2. Press [CAL] [CALIBRATE MENU] [S11 1-PORT] and perform an S11 1-port calibration using an open, a short, and a load connected to port 1. Press [DONE 1-PORT CAL], then save the configuration in one of the save registers.

3. Connect one or more lengths of cable, with adapters between cable sections, as shown at the top of Figure 8-3.
4. Press [SYSTEM] [TRANSFORM MENU] [BANDPASS] [TRANSFORM ON].
5. Press [START] [0] [x1] to select a start time of zero seconds.
6. Press [STOP] [4] [0] [G/n] to select a stop time of 40 nanoseconds.

NOTE: In the time domain, the STIMULUS keys ([START], [STOP], [CENTER] and [SPAN]) refer to time, and can be used to change the horizontal (time) axis of the display, independent of the chosen frequency range. To set the STOP time long enough to let you "see" the end of the cable under test, enter a STOP time of 10 nanoseconds per metre of cable under test. This is a good rule-of-thumb number that accounts for the approximate round-trip time for most cables.

7. Press [FORMAT] [LIN MAG] for a display of reflection coefficient versus time (or distance).
8. Press [SCALE REF] [AUTO SCALE].

Figure 8-3 shows typical frequency and time domain responses of a reflection measurement of two sections of cable.

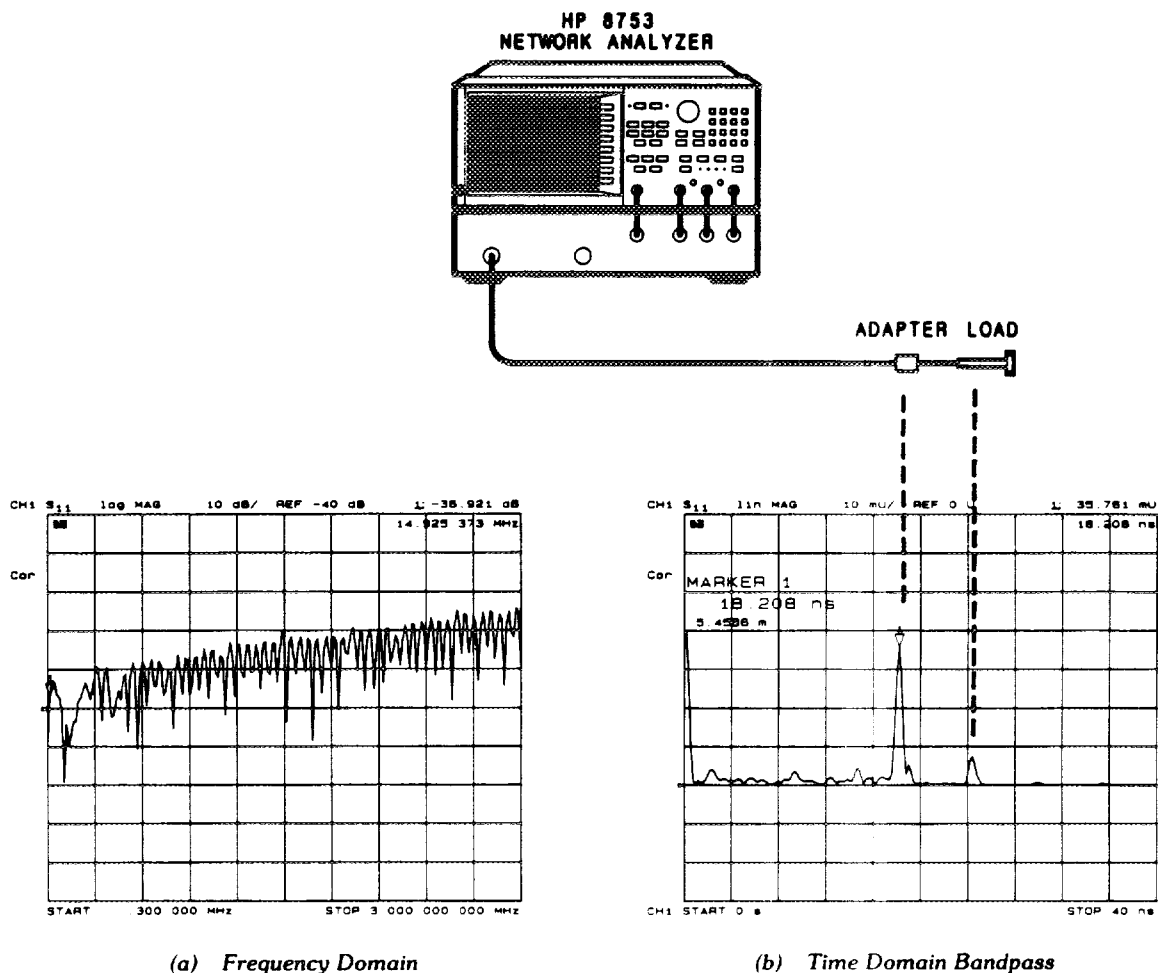

Figure 8-3. A Reflection Measurement of Two Cables

The ripples in reflection coefficient versus frequency in the frequency domain measurement are caused by the reflections at each connector "beating" against each other.

One at a time, loosen the connectors at each end of the cable and observe the response in both the frequency domain and the time domain. The frequency domain ripples grow as each connector is loosened, corresponding to a larger reflection adding in and out of phase with the other reflections. The time domain responses grow as you loosen the connector that corresponds to each response.

Interpreting the Bandpass Reflection Response Horizontal Axis. In bandpass reflection measurements, the horizontal axis represents the time it takes for an impulse launched at the test port to reach a discontinuity and return to the test port (the two-way travel time). In Figure 8-3, each connector is a discontinuity.

Interpreting the Bandpass Reflection Response Vertical Axis. The quantity displayed on the vertical axis depends on the selected format. The common formats are listed in Table 8-1. The default format is LOG MAG (logarithmic magnitude), which displays the return loss in decibels (dB). LIN MAG (linear magnitude) is a format that displays the response as reflection coefficient (ρ). This can be thought of as an average reflection coefficient of the discontinuity over the frequency range of the measurement. Use the REAL format only in low pass mode.

Adjusting the Relative Velocity Factor

A marker provides both the time (x2) and the electrical length (x2) to a discontinuity. To determine the physical length, rather than the electrical length, change the velocity factor to that of the medium under test:

1. Press [CAL] [MORE] [VELOCITY FACTOR].
2. Enter a velocity factor between 0 and 1.0 (1.0 corresponds to the speed of light in a vacuum). Most cables have a velocity factor of 0.66 (polyethylene dielectrics) or 0.70 (teflon dielectrics).

NOTE: To cause the markers to read the actual one-way distance to a discontinuity, rather than the round trip distance, enter one-half the actual velocity factor.

Transmission Measurements Using Bandpass Mode

The bandpass mode can also transform transmission measurements to the time domain. For example, this mode can provide information about a surface acoustic wave (SAW) filter that is not apparent in the frequency domain. Figure 8-4 illustrates a time domain bandpass measurement of a 321 MHz SAW filter.

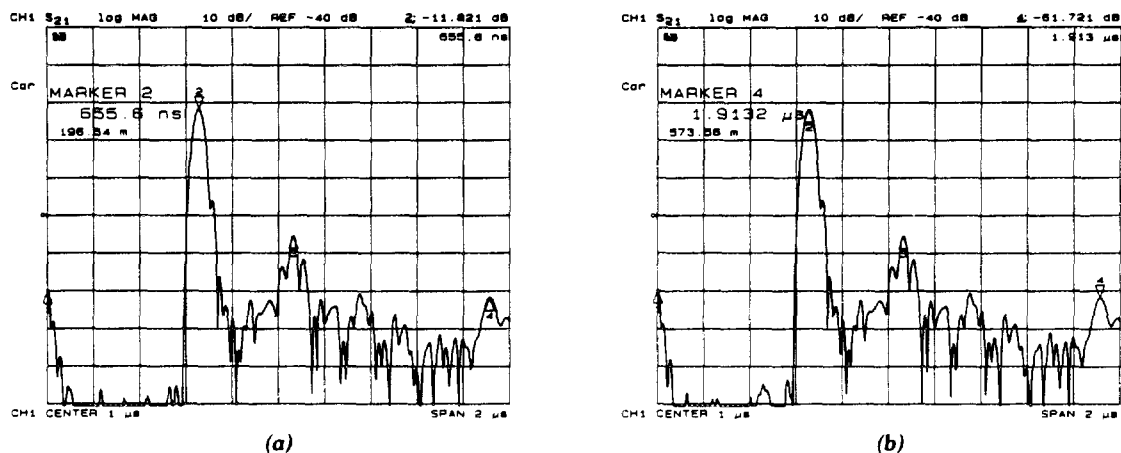

Figure 8-4. Transmission Measurement in Time Domain Bandpass Mode

Interpreting the Bandpass Transmission Response Horizontal Axis. In time domain transmission measurements, the horizontal axis is displayed in units of time. The time axis indicates the propagation delay through the device. Note that in time domain transmission measurements, the value displayed is the actual delay (not x2). The marker provides the propagation delay in both time and distance.

Marker 2 in Figure 8-4a indicates the main path response through the device, which has a propagation delay of 655.6 ns, or about 196.5 meters in electrical length. Marker 4 in Figure 8-4b indicates the triple-travel path response at 1.91 μ s, or about 573.5 meters. The response at marker 1 (at 0 seconds) is an RF feedthrough leakage path. In addition to the triple travel path response, there are several other multi-path responses through the device, which are inherent in the design of a SAW filter.

Interpreting the Bandpass Transmission Response Vertical Axis. In the log magnitude format, the vertical axis displays the transmission loss or gain in dB; in the linear magnitude format it displays the transmission coefficient (τ). Think of this as an average of the transmission response over the measurement frequency range.

TIME DOMAIN LOW PASS

This mode is used to simulate a traditional time domain reflectometry (TDR) measurement. It provides information to determine the type of discontinuity (resistive, capacitive, or inductive) that is present. Low pass provides the best resolution for a given bandwidth in the frequency domain. It may be used to give either the step or impulse response of the DUT.

The low pass mode is less general-purpose than the bandpass mode because it places strict limitations on the measurement frequency range. The low pass mode requires that the frequency domain data points are harmonically related from DC to the stop frequency. That is, $\text{stop} = n \times \text{start}$, where n = number of points. For example, with a start frequency of 300 kHz and 101 points, the stop frequency would be 30.3 MHz. Since the analyzer frequency range starts at 300 kHz (3 MHz in the option 006 6 GHz mode with an HP 85047A test set), the DC frequency response is extrapolated from the lower frequency data. The requirement to pass DC is the same limitation that exists for traditional TDR.

Setting Frequency Range for Time Domain Low Pass

Before a low pass measurement is made, the measurement frequency range must meet the ($\text{stop} = n \times \text{start}$) requirement described above. The **[SET FREQ LOW PASS]** softkey performs this function automatically: the stop frequency is set close to the entered stop frequency, and the start frequency is set equal to stop/n . For convenience, the **[SET FREQ LOW PASS]** softkey is in both the transform menu and the calibration menu.

If the low end of the measurement frequency range is critical, it is best to calculate approximate values for the start and stop frequencies before pressing **[SET FREQ LOW PASS]** and calibrating. This avoids distortion of the measurement results. To see an example, select the preset values of 201 points and a 300 kHz to 3 GHz frequency range. Now press **[SET FREQ LOW PASS]** and observe the change in frequency values. The stop frequency changes to 2.999 GHz, and the start frequency changes to 14.925 MHz. This would cause a distortion of measurement results for frequencies from 300 kHz to 14.925 MHz.

NOTE: If the start and stop frequencies do not conform to the low pass requirement before a low pass mode (step or impulse) is selected and transform is turned on, the analyzer resets the start and stop frequencies. If error correction is on when the frequency range is changed, this turns it off.

Minimum Allowable Stop Frequencies. The lowest analyzer measurement frequency is 300 kHz (3 MHz in the option 006 6 GHz mode), therefore for each value of n there is a minimum allowable stop frequency that can be used. That is, the minimum stop frequency = n x 300 kHz (or n x 3 MHz). Table 8-2 lists the minimum frequency range that can be used for each value of n for low pass time domain measurements.

NOTE: In the 6 GHz mode (option 006 only), the minimum frequency can be set below 3 MHz, although instrument specifications do not apply in this case.

Table 8-2. Minimum Frequency Ranges for Time Domain Low Pass

Number of Points	Minimum Frequency Range	
	Standard Instrument	Option 006 6 GHz Mode
3	300 kHz to 0.9 MHz	3 MHz to 9 MHz
11	300 kHz to 3.3 MHz	3 MHz to 33 MHz
26	300 kHz to 7.8 MHz	3 MHz to 78 MHz
51	300 kHz to 15.3 MHz	3 MHz to 153 MHz
101	300 kHz to 30.3 MHz	3 MHz to 303 MHz
201	300 kHz to 60.3 MHz	3 MHz to 603 MHz
401	300 kHz to 120.3 MHz	3 MHz to 1.203 GHz
801	300 kHz to 240.3 MHz	3 MHz to 2.403 GHz
1601	300 kHz to 480.3 MHz	3 MHz to 4.803 GHz

Reflection Measurements in Time Domain Low Pass

Example:

1. Press **[PRESET]**. The default measurement at preset (with an S-parameter test set) is S11 on channel 1.
2. Press **[CAL] [CALIBRATE MENU] [SET FREQ LOW PASS]**. The message "LOW PASS: FREQ LIMITS CHANGED" will be displayed.
3. Press **[S11 1-PORT]**, and perform an S11 1-port calibration.
4. Connect one or more lengths of cable, with adapters between cable sections. Leave the last cable unterminated.
5. Press **[SYSTEM] [TRANSFORM MENU] [LOW PASS STEP] [TRANSFORM ON]**.
6. Press **[START] [0] [x1]** to select a start time of 0 seconds.
7. Press **[STOP] [4] [0] [G/n]** to select a stop time of 40 nanoseconds.

NOTE: In the time domain, the STIMULUS keys (**[START]**, **[STOP]**, **[CENTER]** and **[SPAN]**) refer to time, and can be used to change the horizontal (time) axis of the display, independent of the chosen frequency range.

8. Press **[FORMAT] [MORE] [REAL] [SCALE REF] [AUTO SCALE]** to view the step response, which will be similar to Figure 8-5a. (The step response is reflected back from the unterminated cable.)

9. Press **[SYSTEM]** **[TRANSFORM MENU]** **[LOW PASS IMPULSE]** to view the impulse response, similar to Figure 8-5b.

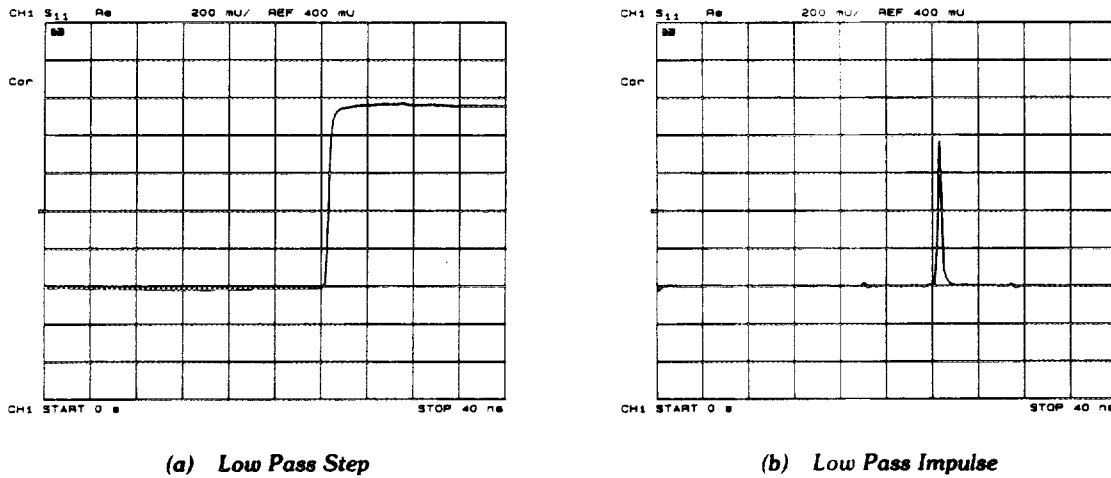

Figure 8-5. Time Domain Low Pass Measurements of an Underterminated Cable

10. Now connect a short circuit to the unterminated cable and press **[SCALE REF]** **[AUTO SCALE]** to center the display. The polarity of the impulse response is now reversed.
11. Press **[SYSTEM]** **[TRANSFORM MENU]** **[LOW PASS STEP]** to view the low pass step response with the polarity reversed.

Interpreting the Low Pass Response Horizontal Axis. The low pass measurement horizontal axis is the two-way travel time to the discontinuity (as in the bandpass mode). The marker displays both the two-way time and the electrical length along the trace. To determine the actual physical length, enter the appropriate velocity factor as described earlier in this chapter under *Adjusting the Relative Velocity Factor*.

Interpreting the Low Pass Response Vertical Axis. The vertical axis depends on the chosen format. In the low pass mode, the frequency domain data is taken at harmonically related frequencies and extrapolated to DC. Because this results in the inverse Fourier transform having only a real part (the imaginary part is zero), the most useful low pass step mode format in this application is the real format. It displays the response in reflection coefficient units. This mode is similar to the traditional TDR response, which displays the reflected signal in a real format (volts) versus time (or distance) on the horizontal axis.

The real format can also be used in the low pass impulse mode, but for the best dynamic range for simultaneously viewing large and small discontinuities, use the log magnitude format.

Fault Location Measurements Using Low Pass

As described, the low pass mode can simulate the TDR response of the device under test. This response contains information useful in determining the type of discontinuity present. Figure 8-6 illustrates the low pass responses of known discontinuities. Each circuit element was simulated to show the corresponding low pass time domain S11 response waveform. The low pass mode gives the device response either to a step or to an impulse stimulus. Mathematically, the low pass impulse stimulus is the derivative of the step stimulus.











Element	Step Response	Impulse Response
Open	 Unity Reflection	 Unity Reflection
Short	 Unity Reflection, -180°	 Unity Reflection, -180°
Resistor $R > Z_0$	 Positive Level Shift	 Positive Peak
Resistor $R < Z_0$	 Negative Level Shift	 Negative Peak
Inductor	 Positive Peak	 Positive Then Negative Peaks
Capacitor	 Negative Peak	 Negative Then Positive Peaks

Figure 8-6. Simulated Low Pass Step and Impulse Response Waveforms (Real Format)

Figure 8-7 shows example cables with discontinuities (faults) using the low pass step mode with the real format.

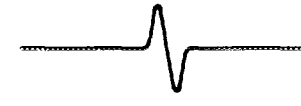

(a) Crimped Cable (Capacitive)

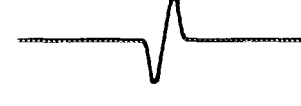
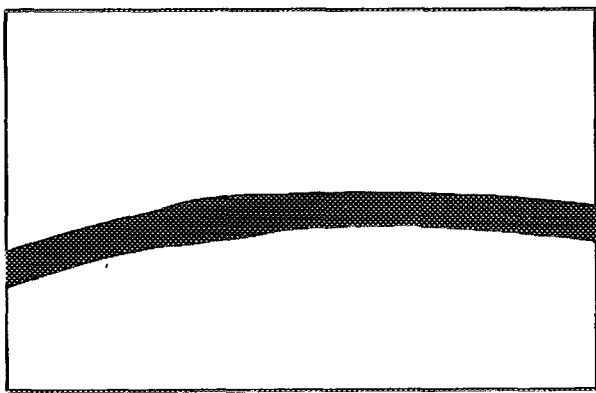
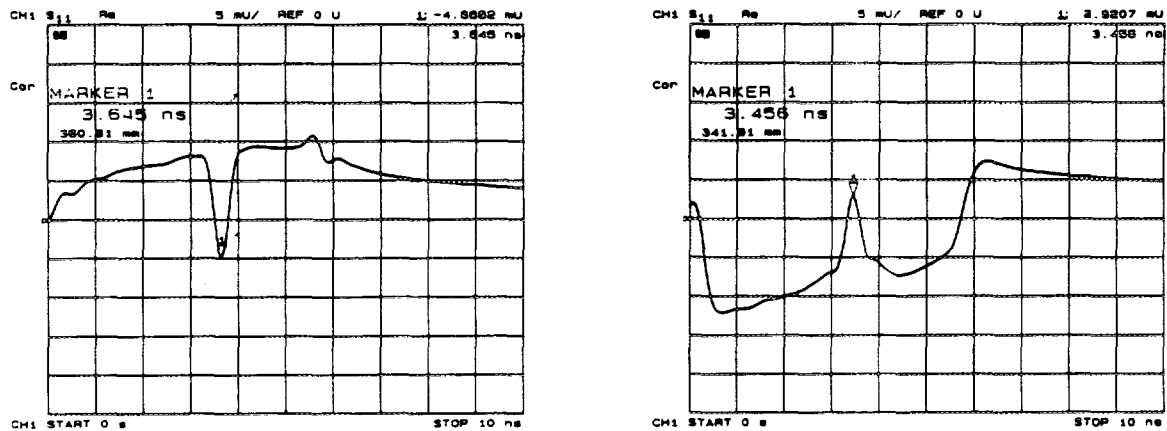
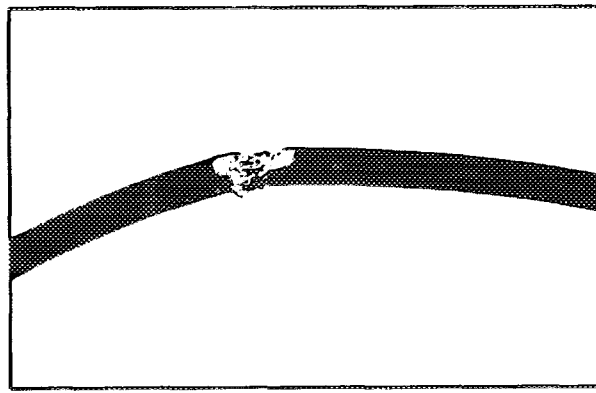

(b) Frayed Cable (Inductive)

Figure 8-7. Low Pass Step Measurements of Common Cable Faults (Real Format)

Transmission Measurements in Time Domain Low Pass

Measuring Small Signal Transient Response Using Low Pass Step. Use the low pass mode to analyze the DUT small signal transient response. The transmission response of a device to a step input is often measured at lower frequencies, using a function generator (to provide the step to the DUT) and a sampling oscilloscope (to analyze the DUT output response). The low pass step mode extends the frequency range of this type of measurement to 3 GHz (6 GHz with an analyzer option 006 and 85047A test set).

The step input shown in Figure 8-8 is the inverse Fourier transform of the frequency domain response of a thru measured at calibration. The step rise time is proportional to the highest frequency in the frequency domain sweep; the higher the frequency, the faster the rise time. The frequency sweep in Figure 8-8 is from 10 MHz to 1 GHz.

Figure 8-8 also illustrates the time domain low pass response of an amplifier under test. The average group delay over the measurement frequency range is the difference in time between the step and the amplifier response. This time domain response simulates an oscilloscope measurement of the amplifier's small signal transient response. Note the ringing in the amplifier response that indicates an underdamped design.

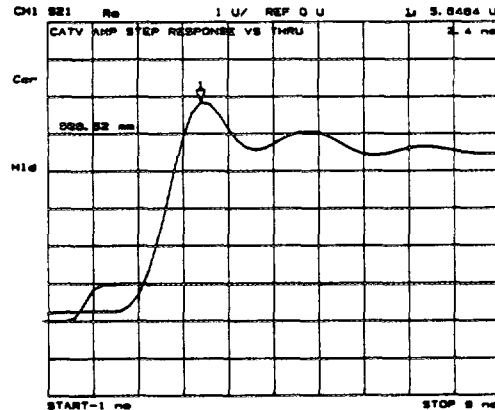

Figure 8-8. Time Domain Low Pass Measurement of an Amplifier Small Signal Transient Response

Interpreting the Low Pass Step Transmission Response Horizontal Axis. The low pass transmission measurement horizontal axis displays the average transit time through the device over the frequency range used in the measurement. The response of the thru connection used in the calibration is a step that reaches 50% unit height at approximately time = 0. The rise time is determined by the highest frequency used in the frequency domain measurement. The step is a unit high step, which indicates no loss for the thru calibration. When a device is inserted, the time axis indicates the propagation delay or electrical length of the device. The markers read the electrical delay in both time and distance. The distance can be scaled by an appropriate velocity factor as described earlier in this chapter under *Adjusting the Relative Velocity Factor*.

Interpreting the Low Pass Step Transmission Response Vertical Axis. In the real format, the vertical axis displays the transmission response in real units (e.g. volts). For the amplifier example in Figure 8-8, if the amplifier input is a step of 1 volt, the output, 2.4 nanoseconds after the step (indicated by marker 1), is 5.84 volts.

In the log magnitude format, the amplifier gain is the steady state value displayed after the initial transients die out.

Measuring Separate Transmission Paths through the DUT Using Low Pass Impulse Mode. The low pass impulse mode can be used to identify different transmission paths through a DUT that has a response at frequencies down to DC (or at least has a predictable response, above the noise floor, below 300 kHz). For example, use the low pass impulse mode to measure the relative transmission times through a multipath device such as a power divider. Another example is to measure the pulse dispersion through a broadband transmission line, such as a fiber optic cable. Both examples are illustrated in Figure 8-9. The horizontal and vertical axes can be interpreted as already described in this chapter under *Transmission Measurements Using Bandpass Mode*.

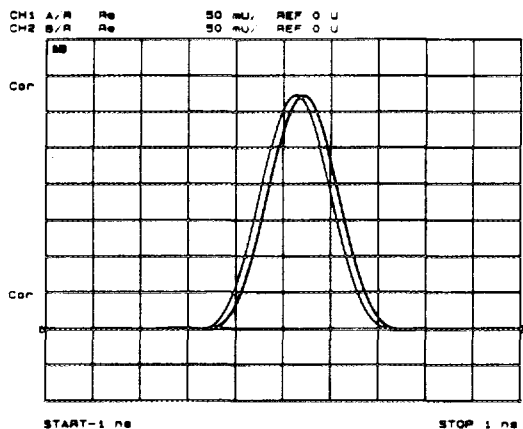

(a) Comparing Transmission Paths through a Power Divider

THRU LINE

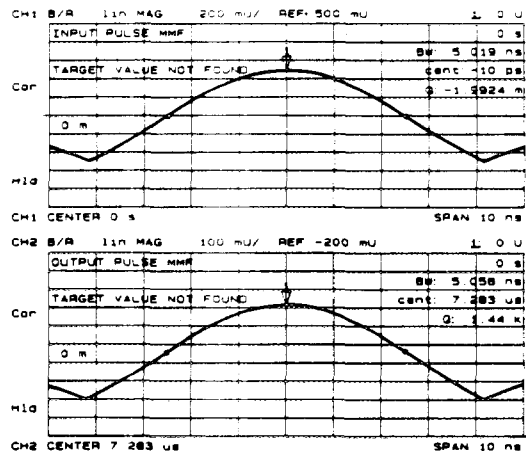

(b) Measuring Pulse Dispersion on a 1.5 km Fiber Optic Cable

Figure 8-9. Transmission Measurements Using Low Pass Impulse Mode

TIME DOMAIN CONCEPTS

Masking

Masking occurs when a discontinuity (fault) closest to the reference plane affects the response of each subsequent discontinuity. This happens because the energy reflected from the first discontinuity never reaches subsequent discontinuities. For example, if a transmission line has two discontinuities that each reflect 50% of the incident voltage, the time domain response (real format) shows the correct reflection coefficient for the first discontinuity ($\rho=0.50$). However, the second discontinuity appears as a 25% reflection ($\rho=0.25$) because only half the incident voltage reached the second discontinuity.

NOTE: This example assumes a lossless transmission line. Real transmission lines, with non-zero loss, attenuate signals as a function of the distance from the reference plane.

As an example of masking due to line loss, consider the time domain response of a 3 dB attenuator and a short circuit. The impulse response (log magnitude format) of the short circuit alone is a return loss of 0 dB, as shown in Figure 8-10a. When the short circuit is placed at the end of the 3 dB attenuator, the return loss is -6 dB, as shown in Figure 8-10b. This value actually represents the forward and return path loss through the attenuator, and illustrates how a lossy network can affect the responses that follow it.

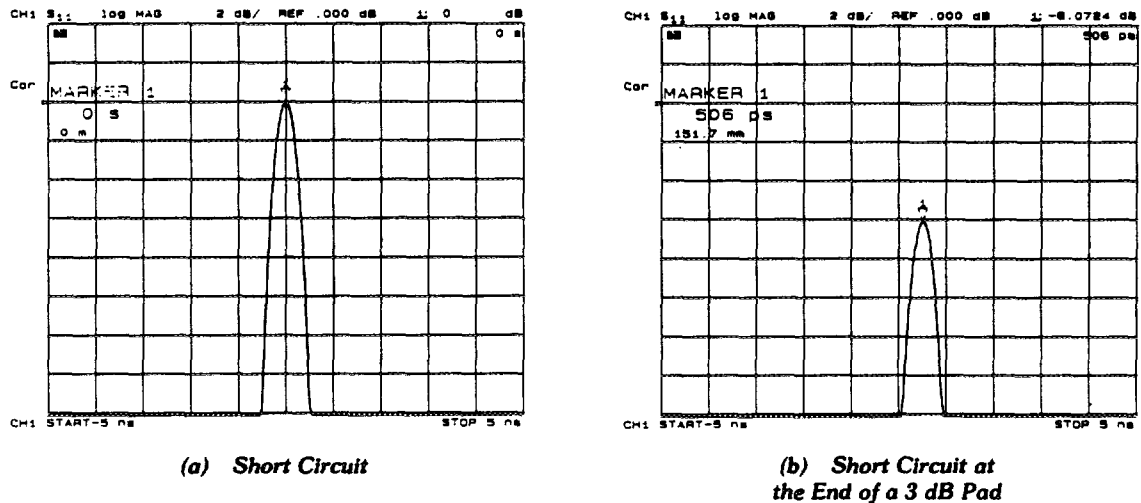

Figure 8-10. Masking Example

Windowing

The analyzer provides a windowing feature that makes time domain measurements more useful for isolating and identifying individual responses. Windowing is needed because of the abrupt transitions in a frequency domain measurement at the start and stop frequencies. The band limiting of a frequency domain response causes overshoot and ringing in the time domain response, and causes a non-windowed impulse stimulus to have a $\text{sin}(kt)/kt$ shape, where $k = \pi/\text{frequency span}$ (see Figure 8-11). This has two effects that limit the usefulness of the time domain measurement:

1. **Finite impulse width (or rise time).** This limits the ability to resolve between two closely spaced responses. The effects of the finite impulse width cannot be improved without increasing the frequency span of the measurement (see Table 8-3).
2. **Sidelobes.** The impulse sidelobes limit the dynamic range of the time domain measurement by hiding low-level responses within the sidelobes of higher level responses. The effects of sidelobes can be improved by windowing (see Table 8-3).

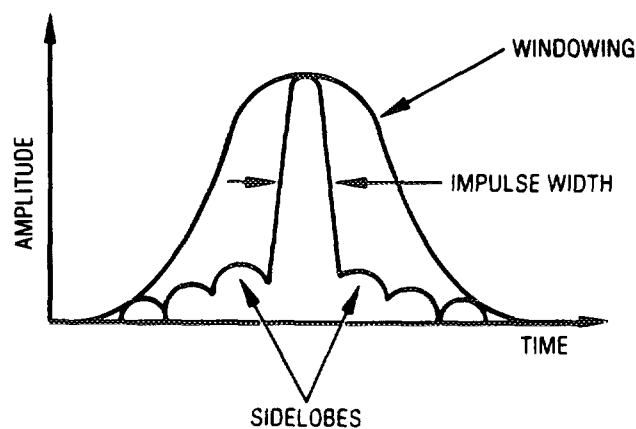

Figure 8-11. Impulse Width, Sidelobes, and Windowing

Windowing improves the dynamic range of a time domain measurement by filtering the frequency domain data prior to converting it to the time domain, producing an impulse stimulus that has lower sidelobes. This makes it much easier to see time domain responses that are very different in magnitude. The sidelobe reduction is achieved, however, at the expense of increased impulse width. The effect of windowing on the step stimulus (low pass mode only) is a reduction of overshoot and ringing at the expense of increased rise time.

To select a window, press **[SYSTEM] [TRANSFORM MENU] [WINDOW]**. A menu is presented that allows the selection of three window types (see Table 8-3).

Table 8-3. Impulse Width, Sidelobe Level, and Windowing Values

Window Type	Impulse Sidelobe Level	Low Pass Impulse Width (50%)	Step Sidelobe Level	Step Rise Time (10 – 90%)
Minimum	– 13 dB	1.20/Freq Span	–21 dB	0.45/Freq Span
Normal	– 44 dB	1.92/Freq Span	–60 dB	0.99/Freq Span
Maximum	– 90 dB	2.88/Freq Span	–90 dB	1.48/Freq Span

NOTE: The bandpass mode simulates an impulse stimulus. Bandpass impulse width is twice that of lowpass impulse width. The bandpass impulse sidelobe levels are the same as lowpass impulse sidelobe levels.

Choose one of the three window shapes listed in Table 8-3. Or you can use the knob to select any windowing pulse width (or rise time for a step stimulus) between the softkey values. The time domain stimulus sidelobe levels depend only on the window selected.

[MINIMUM] is essentially no window. Consequently, it gives the highest sidelobes.

[NORMAL] (the preset mode) gives reduced sidelobes and is the mode most often used.

[MAXIMUM] window gives the minimum sidelobes, providing the greatest dynamic range.

[USE MEMORY on OFF] remembers a user-specified window pulse width (or step rise time) different from the standard window values.

A window is turned on only for viewing a time domain response, and does not affect a displayed frequency domain response. Figure 8-12 shows the typical effects of windowing on the time domain response of a short circuit reflection measurement.

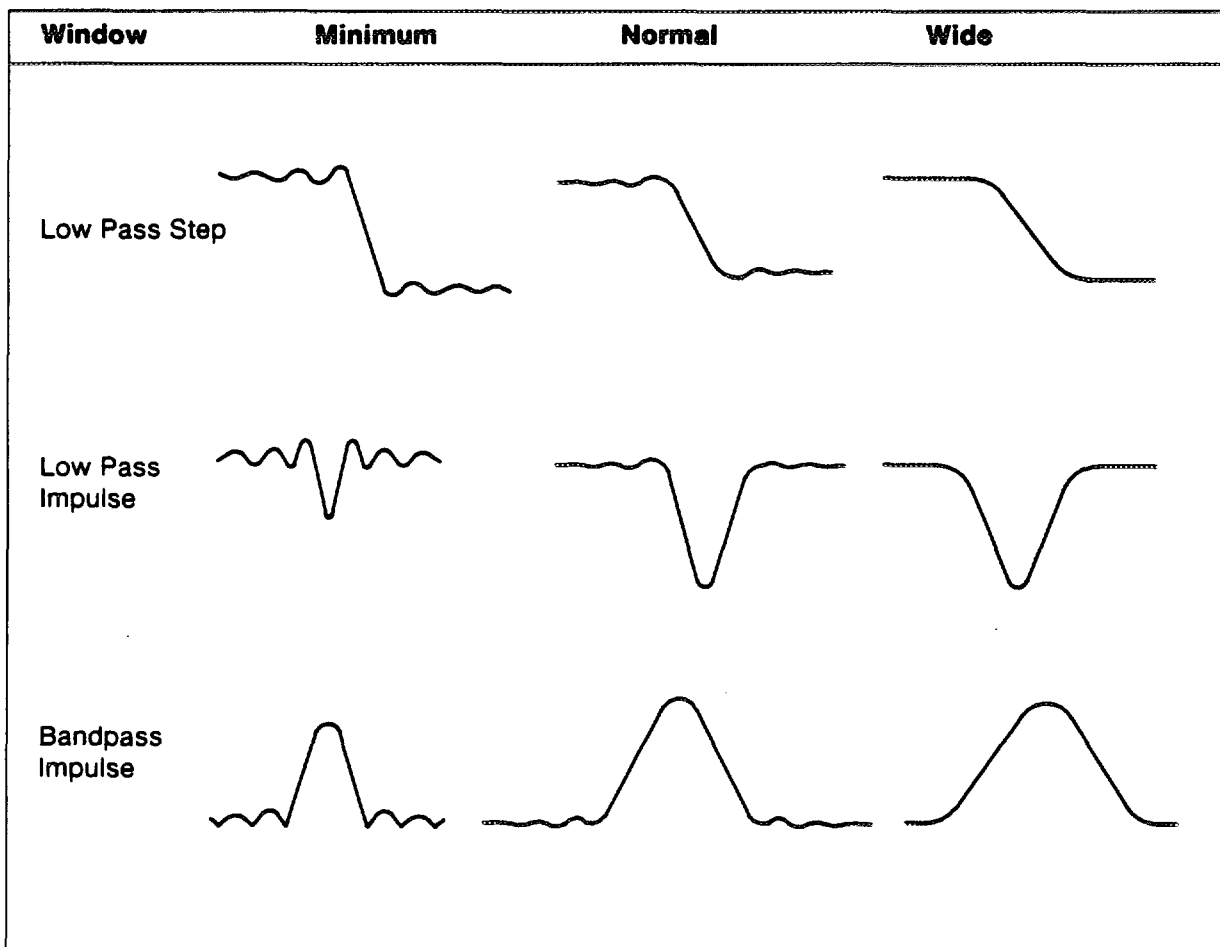

Figure 8-12. The Effects of Windowing on the Time Domain Responses of a Short Circuit

Range

In the time domain, range is defined as the length in time that a measurement can be made without encountering a repetition of the response, called aliasing. A time domain response repeats at regular intervals because the frequency domain data is taken at discrete frequency points, rather than continuously over the frequency band.

Measurement range is equal to $1/\Delta F$ (ΔF is the spacing between frequency data points). Measurement range = (number of points - 1)/frequency span (Hz).

Example:

$$\begin{aligned} \text{Measurement} &= 201 \text{ points} \\ &1 \text{ MHz to } 2.001 \text{ GHz} \end{aligned}$$

$$\begin{aligned} \text{Range} &= 1/\Delta F \text{ or } (\text{number of points} - 1)/\text{frequency span} \\ &= 1/(10 \times 10^6) \text{ or } (201 - 1)/(2 \times 10^9) \\ &= 100 \times 10^{-9} \text{ seconds} \end{aligned}$$

$$\begin{aligned} \text{Electrical length} &= \text{range} \times \text{the speed of light } (3 \times 10^8 \text{ m/s}) \\ &= (100 \times 10^{-9} \text{ s}) \times (3 \times 10^8 \text{ m/s}) \\ &= 30 \text{ metres} \end{aligned}$$

In this example, the range is 100 ns, or 30 metres electrical length. To prevent the time domain responses from overlapping, the DUT must be 30 metres or less in electrical length for a transmission measurement (15 metres for a reflection measurement). The analyzer limits the stop time to prevent the display of aliased responses.

To increase the time domain measurement range, first increase the number of points, but remember that as the number of points increases, the sweep speed decreases. Decreasing the frequency span also increases range, but reduces resolution.

Resolution

Two different resolution terms are used in the time domain:

1. Response Resolution.
2. Range Resolution.

Response Resolution. Time domain response resolution is defined as the ability to resolve two closely-spaced responses, or a measure of how close two responses can be to each other and still be distinguished from each other. For responses of equal amplitude, the response resolution is equal to the 50% (–6 dB) impulse width. It is inversely proportional to the measurement frequency span, and is also a function of the window used in the transform. The approximate formulas for calculating the 50% impulse width are given in Table 8-3.

For example, using the formula for the bandpass mode with a normal windowing function for a 1 MHz to 3.001 GHz measurement (3 GHz span):

$$\begin{aligned} 50\% \text{ calculated impulse width} &= 1.2 \times (1/3 \text{ GHz}) \times 1.6 \\ &= 0.64 \text{ nanoseconds} \end{aligned}$$

$$\begin{aligned} \text{Electrical length (in air)} &= (0.64 \times 10^{-9} \text{ s}) \times (30 \times 10^9 \text{ cm/s}) \\ &= 19.2 \text{ centimetres} \end{aligned}$$

With this measurement, two equal responses can be distinguished when they are separated by at least 19.2 centimetres. In a 6 GHz measurement with an option 006 analyzer and an HP 85047A test set, two equal responses can be distinguished when they are separated by at least 9.6 cm.

Using the low pass mode (the low pass frequencies are slightly different) with a minimum windowing function, you can distinguish two equal responses that are about 6 centimetres or more apart.

For reflection measurements, which measure the round trip time to the response, divide the response resolution by 2. Using the example above, you can distinguish two faults of equal magnitude provided they are 3 centimetres (electrical length) or more apart.

NOTE: Remember, to determine the physical length, enter the relative velocity factor of the transmission medium under test.

For example, a cable with a teflon dielectric (0.7 relative velocity factor), measured under the conditions stated above, has a fault location measurement response resolution of 2.1 centimetres. This is the maximum fault location response resolution. Factors such as reduced frequency span, greater frequency domain data windowing, and a large discontinuity shadowing the response of a smaller discontinuity, all act to degrade the effective response resolution.

Figure 8-13 illustrates the effects of response resolution. The solid line shows the actual reflection measurement of two approximately equal discontinuities (the input and output of an SMA barrel). The dashed line shows the approximate effect of each discontinuity, if they could be measured separately.

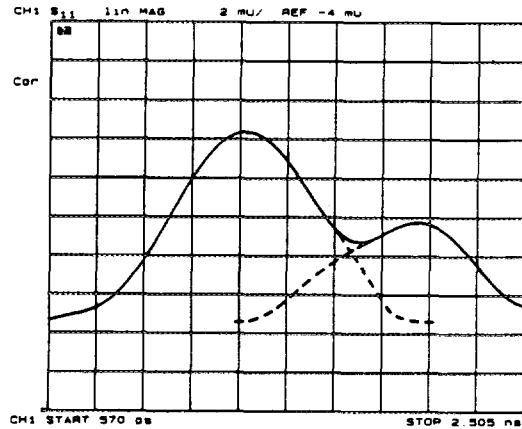

Figure 8-13. Response Resolution

While increasing the frequency span increases the response resolution, keep the following points in mind:

1. The time domain response noise floor is directly related to the frequency domain data noise floor. Because of this, if the frequency domain data points are taken at or below the measurement noise floor, the time domain measurement noise floor is degraded.
2. The time domain measurement is an average of the response over the frequency range of the measurement. If the frequency domain data is measured out-of-band, the time domain measurement is also the out-of-band response.

You may (with these limitations in mind) choose to use a frequency span that is wider than the DUT bandwidth to achieve better resolution.

Range Resolution. Time domain range resolution is defined as the ability to locate a single response in time. If only one response is present, range resolution is a measure of how closely you can pinpoint the peak of that response. The range resolution is equal to the digital resolution of the display, which is the time domain span divided by the number of points on the display. To get the maximum range resolution, center the response on the display and reduce the time domain span. The range resolution is always much finer than the response resolution.

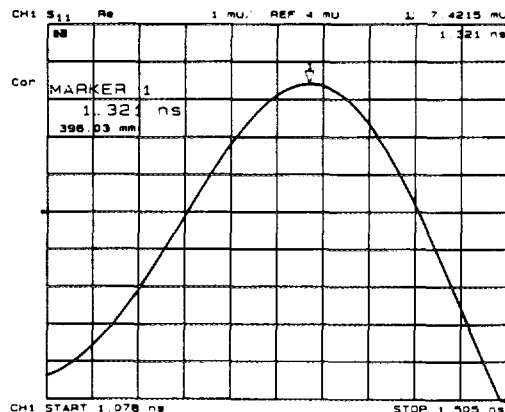

Figure 8-14. Range Resolution of a Single Discontinuity

Gating

Gating provides the flexibility of selectively removing time domain responses. The gated time domain responses can then be transformed back to the frequency domain. For reflection (or fault location) measurements, use this feature to remove the effects of unwanted discontinuities in the time domain. You can then view the frequency response of the remaining discontinuities. In a transmission measurement, you can remove the effects of multiple transmission paths.

Figure 8-15 illustrates the time domain response of a SAW filter. Gating has been applied in the time domain to remove the effects of all but the main signal path response. When the gated response is transformed back to the frequency domain, the display shows only the direct path response.

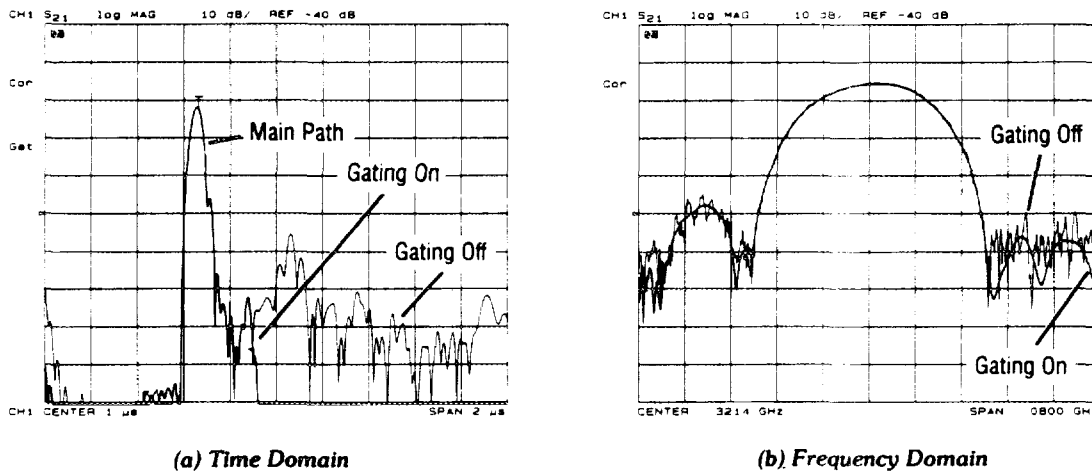

Figure 8-15. SAW Filter Transmission Measurement with Gating

Setting the Gate. Think of a gate as a bandpass filter in the time domain (Figure 8-16). When the gate is on, responses outside the gate are mathematically removed from the time domain trace. Enter the gate position as a start and stop time (not frequency) or as a center and span time. The start and stop times are the bandpass filter -6 dB cutoff times. Gates can have a negative span, in which case the responses *inside* the gate are mathematically removed.

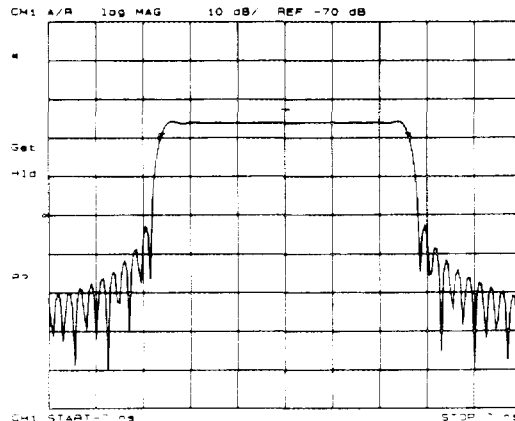

Figure 8-16. Gate Shape

Selecting Gate Shape. The four gate shapes available are listed in Table 8-4. Each gate has a different passband flatness, cutoff rate, and sidelobe levels.

Table 8-4. Gate Characteristics

Gate Shape	Passband Ripple	Sidelobe Levels	Cutoff Time	Minimum Gate Span
Gate Span Minimum	±0.40 dB	−24 dB	0.6/Freq Span	1.2/Freq Span
Normal	±0.04 dB	−45 dB	1.4/Freq Span	2.8/Freq Span
Wide	±0.02 dB	−52 dB	4.0/Freq Span	8.0/Freq Span
Maximum	±0.01 dB	−80 dB	11.2/Freq Span	22.4/Freq Span

NOTE: With 1601 frequency points, gating is available only in the passband mode.

The passband ripple and sidelobe levels are descriptive of the gate shape. The cutoff time is the time between the stop time (−6 dB on the filter skirt) and the peak of the first sidelobe, and is equal on the left and right side skirts of the filter. Because the minimum gate span has no passband, it is just twice the cutoff time. Always choose a gate span wider than the minimum. For most applications, do not be concerned about the minimum gate span, simply use the knob to position the gate markers around the desired portion of the time domain trace.

TRANSFORMING CW TIME MEASUREMENTS INTO THE FREQUENCY DOMAIN

The analyzer can display the amplitude and phase of continuous wave (CW) signals versus time. For example, use this mode for measurements such as amplifier gain as a function of warm-up time (i.e. drift). In the past, drift measurements were often made using strip chart recorders. The analyzer can display the measured parameter (e.g. amplifier gain) for periods of up to 24 hours and then output the data to a digital plotter for hardcopy results.

These “strip chart” plots are actually measurements as a function of time (time is the independent variable), and the horizontal display axis is scaled in time units. Transforms of these measurements result in frequency domain data. Such transforms are called forward transforms because the transform from time to frequency is a forward Fourier transform, and can be used to measure the spectral content of a CW signal. For example, when transformed into the frequency domain, a pure CW signal measured over time appears as a single frequency spike. The transform into the frequency domain yields a display that looks similar to a spectrum analyzer display of signal amplitude versus frequency.

Forward Transform Measurements

This is an example of a measurement using the Fourier transform in the forward direction, from the time domain to the frequency domain (see Figure 8-17):

1. Press **[PRESET]**.
2. Press **[MEAS]** and select the desired measurement (in this case B/R).
3. Press **[MENU] [CW FREQ]** and set the CW frequency to the desired value (here 250 MHz). The CW time mode is now active.

4. Press **[STOP]** and enter the time over which you wish to take data (up to 24 hours, in this case 0.1 second).
5. Press **[SYSTEM] [TRANSFORM MENU] [TRANSFORM ON]** to transform the data into the frequency domain.
6. Press **[SPAN]** and set the desired frequency span. For this example, press **[5] [0] [0] [x1]** to increase the frequency span to 500 Hz. The displayed center frequency of 0 Hz represents the CW frequency of 250 MHz entered earlier. The maximum span is 4000 Hz for the default sweep time (100 ms) and number of points (201) (see *Forward Transform Range*)

NOTE: In the forward transform mode, the k/m, M/ μ , and G/n keys terminate a selection as millihertz, microhertz, and nanohertz.

7. Press **[SCALE REF]** and adjust the scale per division and reference position to view the trace centered on the screen.
8. Press **[MKR FCTN] [MKR SEARCH] [MAX]** to see the peak value.

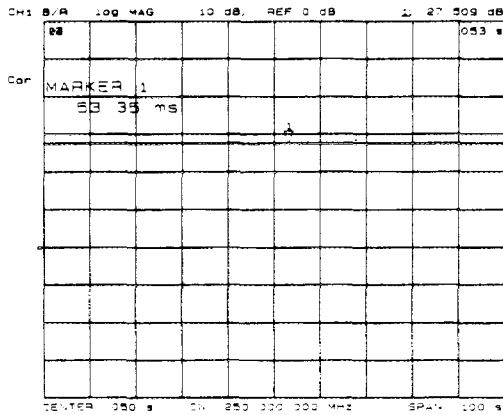

(a) CW Time

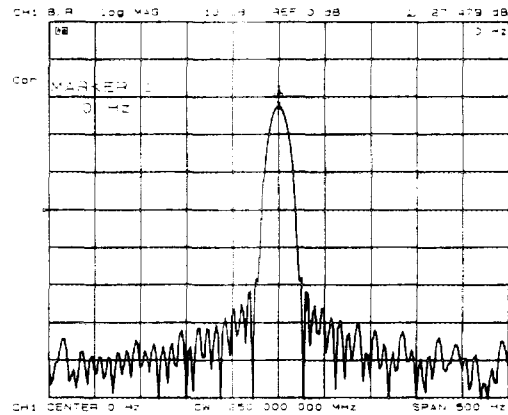

(b) Transform to Frequency Domain

Figure 8-17. Amplifier Gain Measurement

Interpreting the Forward Transform Vertical Axis. With the log magnitude format selected, the vertical axis displays dB. This format simulates a spectrum analyzer display of power versus frequency.

Interpreting the Forward Transform Horizontal Axis. In a frequency domain transform of a CW time measurement, the horizontal axis is measured in units of frequency. The center frequency is the offset of the CW frequency. For example, with a center frequency of 0 Hz, the CW frequency (250 MHz in the example) is in the center of the display. If the center frequency entered is a positive value, the CW frequency shifts to the right half of the display; a negative value shifts it to the left half of the display. The span value entered with the transform on is the total frequency span shown on the display. (Alternatively, the frequency display values can be entered as start and stop.)

Demodulating the Results of the Forward Transform

The forward transform can separate the effects of the CW frequency modulation amplitude and phase components. For example, if a DUT modulates the transmission response (S21) with a 500 Hz AM signal, you can see the effects of that modulation as shown in Figure 8-18. To simulate this effect, connect a 500 Hz sine wave to the analyzer rear panel EXT AM input.

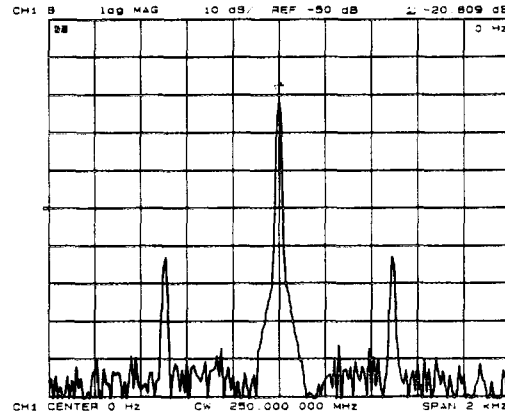

Figure 8-18. Combined Effects of Amplitude and Phase Modulation

Using the demodulation capabilities of the analyzer, it is possible to view the amplitude or the phase component of the modulation separately. The window menu (see Figure 8-2) includes the following softkeys to control the demodulation feature:

[DEMOD: OFF] This is the normal preset state, in which both the amplitude and phase components of any DUT modulation appear on the display.

[AMPLITUDE] displays only the amplitude modulation (AM), as illustrated in Figure 8-19a.

[PHASE] displays only the phase modulation (PM), as shown in Figure 8-19b.

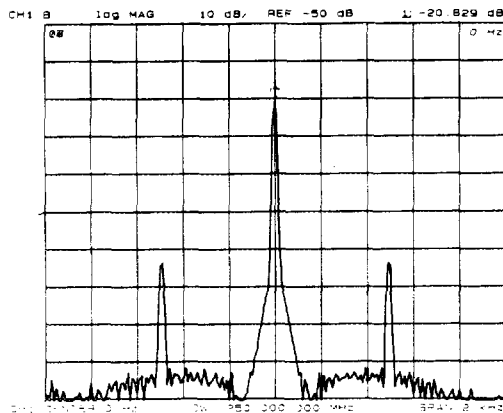

(a) Amplitude Modulation Component

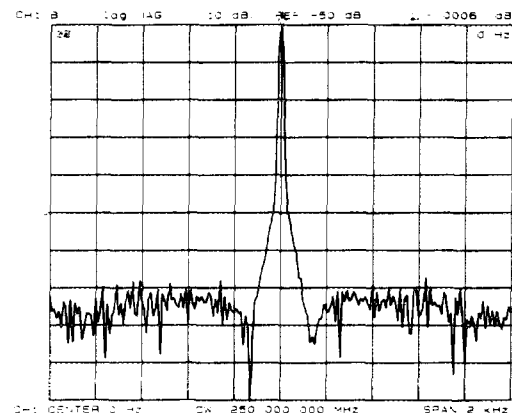

(b) Phase Modulation Component

Figure 8-19. Separating the Amplitude and Phase Components of DUT-Induced Modulation

Forward Transform Range

In the forward transform (from CW time to the frequency domain), range is defined as the frequency span that can be displayed before aliasing occurs, and is similar to range as defined for time domain measurements. In the range formula, substitute time span for frequency span.

Example:

$$\begin{aligned} \text{Range} &= (\text{Number of points} - 1) / \text{time span} \\ &= (201 - 1) / (200 \times 10^{-3}) \\ &= 1000 \text{ Hertz} \end{aligned}$$

For the example given above, a 201 point CW time measurement made over a 200 ms time span, choose a span of 1 kHz or less on either side of the center frequency (Figure 8-20). That is, choose a total span of 2 kHz or less.

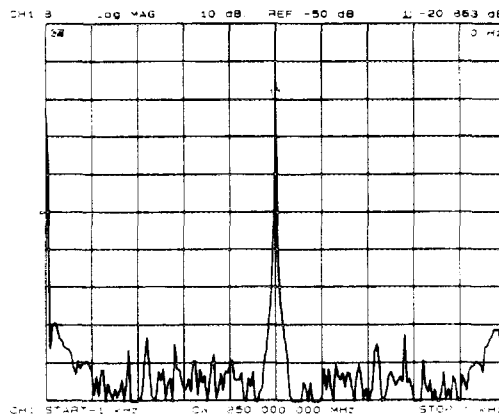

Figure 8-20. Range of a Forward Transform Measurement

To increase the frequency domain measurement range, increase the span. The maximum range is inversely proportional to the sweep time, therefore it may be necessary to increase the number of points or decrease the sweep time. Because increasing the number of points increases the auto sweep time, the maximum range is 2 kHz on either side of the selected CW time measurement center frequency (4 kHz total span). To display a total frequency span of 4 kHz, enter the span as 4000 Hz.

Chapter 9. Making a Hard Copy Output

CHAPTER CONTENTS

- 9-1 Introduction
- 9-2 [COPY] Key
- 9-2 Copy Menu
- 9-4 Print/Plot Setups Menu
- 9-5 Select Quadrant Menu
- 9-6 Define Plot Menu
- 9-7 Configure Plot Menu
- 9-9 Screen Menu

INTRODUCTION

The analyzer can use HP-IB to output measurement results directly to a compatible printer or plotter, without the use of an external controller. The information displayed on the CRT can be copied to a compatible Hewlett-Packard plotter or graphics printer. A plotter provides better resolution than a printer for data displays, while a printer provides higher speed for tabular listings. Refer to the *General Information and Specifications* section of this manual for information about compatible plotters and printers.

To generate a plot or printout from the front panel when there is no other controller on the bus, the analyzer must be in system controller HP-IB mode. To take control from the computer and initiate a plot or printout, the analyzer must be in pass control mode. If it is not in one of these modes, the message "SYST CTRL or PASS CTRL in LOCAL menu" is displayed. Refer to [LOCAL] Key in Chapter 7 for information on HP-IB controller modes and setting addresses.

Print/Plot Buffer

The analyzer can continue operation while a plot or printout is run. To abort a plot or print in progress, press [LOCAL]. If a print or plot is in progress and a second print or plot is attempted, the message "PRINT/PLOT IN PROGRESS, ABORT WITH LOCAL" is displayed and the second attempt is ignored. An aborted plot or printout cannot be continued: the process must be initiated again if a copy is still required.

[COPY] KEY

The HP-IB programming command is shown in parenthesis following the key or softkey.

The [COPY] key provides access to the menus used for controlling external plotters and printers and defining the plot parameters.

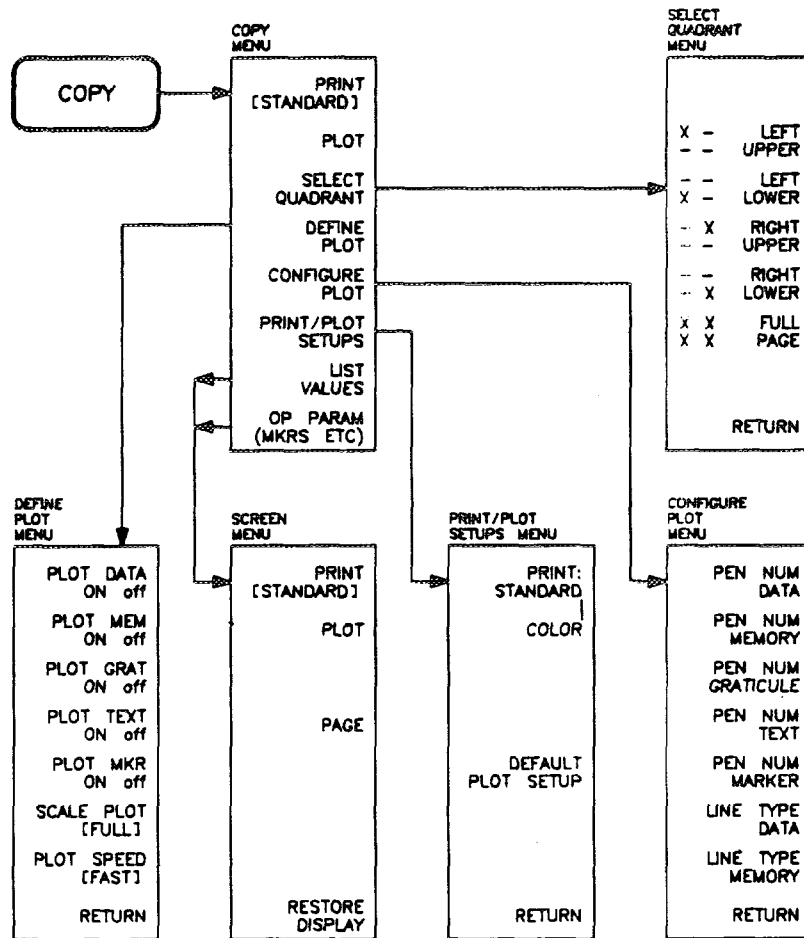

Figure 9-1. Softkey Menus Accessed from the [COPY] Key

Copy Menu

The copy menu can be used to copy to a printer or to plot using default plot parameters, without the need to access other menus. For user-defined plot parameters, a series of additional menus is available.

This menu also provides tables of operating parameters and measured data values, which can be copied from the screen to a printer or plotter.

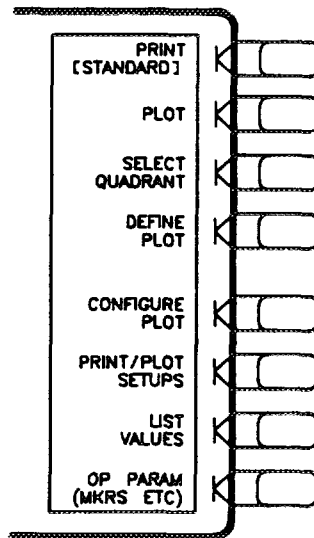

Figure 9-2. Copy Menu

When the print or plot function is engaged, the analyzer freezes the data on the CRT and sends it to the printer or plotter through a buffer. Once the data is transferred to the buffer, the analyzer is free to continue measurements while the data is printing or plotting.

[PRINT [STANDARD]] (PRINALL) identifies the printer selected in the print/plot setups menu: either **[STANDARD]** for a black and white printer or **[COLOR]** for a color printer. The default setting at power on is standard. When pressed, this softkey engages the print function and data is sent to the printer for printing.

[PLOT] (PLOT) plots the CRT display to a compatible HP graphics plotter, using the currently defined plot parameters (or default parameters). Any or all displayed information can be plotted, except the softkey labels and CRT listings such as the frequency list table or limit table. (List values and operating parameters can be plotted using the screen menu explained later in this chapter. However, this is considerably slower than printing.)

To achieve the fastest actual plotting time, place the analyzer in Hold mode, limit pen changes, and limit complex functions such as averaging and calibration interpolation. The simplest configuration yields the fastest plot times.

[SELECT QUADRANT] leads to the the select quadrant menu, which provides the capability of drawing quarter-page plots. This is not used for printing.

[DEFINE PLOT] leads to the define plot menu, which is used to specify which elements of the display are to be plotted. This is not used for printing.

[CONFIGURE PLOT] leads to the configure plot menu, which defines the pen number and line type for each of the plot elements. This is not used for printing.

[PRINT/PLOT SETUPS] presents the print/plot setups menu. This menu allows you to copy the CRT display to a printer capable of a graphics plot or tabular listings. The analyzer is designed to be compatible with the HP 2225A ThinkJet, the HP 3630A PaintJet, and the HP 2227 QuietJet Plus. Other Hewlett-Packard printers may also be compatible with the analyzer.

The printer speed may be slower when error correction, time domain functions, or other data processing functions are enabled. Press **[LOCAL]** to abort a printout.

[LIST VALUES] (LISV) provides a tabular listing of all the measured data points and their current values, together with limit information if it is turned on. At the same time, the screen menu is presented, to enable hard copy listings and access new pages of the table. 30 lines of data are listed on each page, and the number of pages is determined by the number of measurement points specified in the stimulus menu.

Up to five columns of data are provided. The specific information listed for each measured data point varies depending on the display format, the limit testing status, and whether or not dual channel display or stimulus coupling is selected. If limit testing is on, an asterisk * is listed next to any measured value that is out of limits. If limit lines are on, and other listed data allows sufficient space, the limits are listed together with the margin by which the device data passes or fails the nearest limit.

[OP PARAM (MKRS ETC)] (OPEP) provides a tabular listing on the CRT of the key parameters for both channels. The screen menu is presented to allow hard copy listings and access new pages of the table. Four pages of information are supplied. These pages list operating parameters, marker parameters, lists and system parameters that relate to control of peripheral devices rather than selection of measurement parameters.

Print/Plot Setups Menu

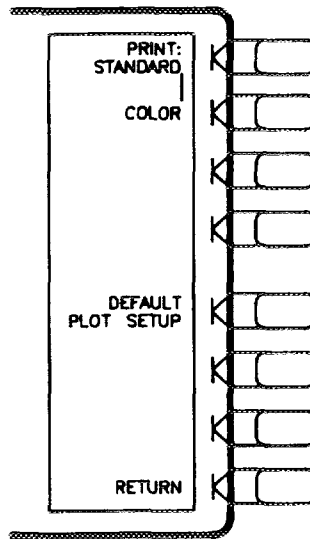

Figure 9-3. Print/Plot Setups Menu

[PRINT: STANDARD] (PRIS) sets the print command to default to a standard printer that prints in black only or a PaintJet to yield a black-only print.

[COLOR] (PRIC) sets the print command to default to a color printer. The printer output is always in the analyzer default color values. The **[PRINT [COLOR]]** command does NOT work with a black and white printer.

[DEFAULT PLOT SETUP] (DFLT) resets the plotting parameters to their default values. These defaults are as follows:

- | | | | | |
|--------------------|-----------------------|---------------|-----------|-----------|
| ● Select quadrant: | Full page. | ● Pen numbers | Channel 1 | Channel 2 |
| ● Define plot: | All plot elements on. | Data | 1 | 2 |
| ● Plot scale: | Full. | Memory | 1 | 2 |
| ● Plot speed: | Fast. | Graticule | 3 | 4 |
| ● Line type: | 7 (solid line). | Text | 1 | 2 |
| | | Marker | 5 | 6 |

Default setups do not apply to printing.

[RETURN] goes back to the copy menu.

Select Quadrant Menu

This menu offers the selection of a full-page plot, or a quarter-page plot in any quadrant of the page.

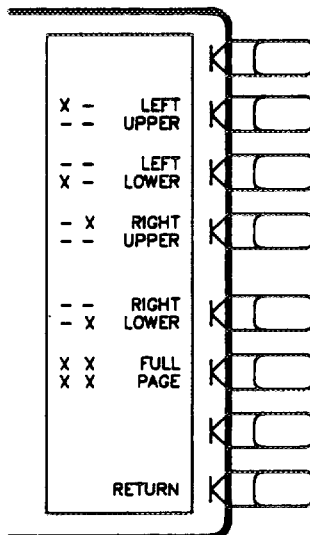

Figure 9-4. Select Quadrant Menu

[LEFT UPPER] (LEFU) draws a quarter-page plot in the upper left quadrant of the page.

[LEFT LOWER] (LEFL) draws a quarter-page plot in the lower left quadrant of the page.

[RIGHT UPPER] (RIGU) draws a quarter-page plot in the upper right quadrant of the page.

[RIGHT LOWER] (RIGL) draws a quarter-page plot in the lower right quadrant of the page.

[FULL PAGE] (FULP) draws a full-size plot according to the scale defined with **[SCALE PLOT]** in the define plot menu (described next).

[RETURN] goes back to the copy menu.

Define Plot Menu

This menu allows selective plotting of portions of the measurement display. Different plot elements can be turned on or off as required. In addition, different selections are available for plot speed and plot scale, to allow plotting on transparencies and preprinted forms.

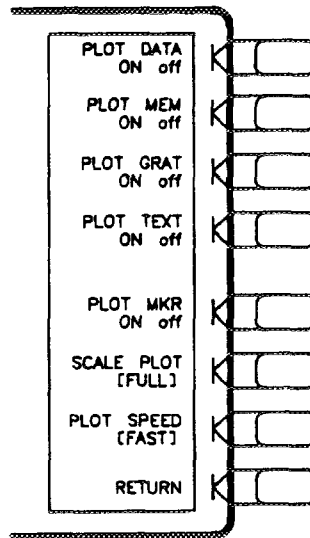

Figure 9-5. Define Plot Menu

[PLOT DATA ON off] (PDATAON, PDATAOFF) specifies whether the data trace is to be drawn (on) or not drawn (off) on the plot.

[PLOT MEM ON off] (PMEON, PMEMOFF) specifies whether the memory trace is to be drawn (on) or not drawn (off) on the plot. Memory can only be plotted if it is displayed (refer to *Display Menu* in Chapter 4).

[PLOT GRAT ON off] (PGRATON, PGRATOFF) specifies whether the graticule and the reference line are to be drawn (on) or not drawn (off) on the plot. Turning **[PLOT GRAT ON]** and all other elements off is a convenient way to make preplotted grid forms. However, when data is to be plotted on a preplotted form, **[PLOT GRAT OFF]** should be selected.

[PLOT TEXT ON off] (PTEXTON, PTEXTOFF) selects plotting of all displayed text except the marker values, softkey labels, and CRT listings such as the frequency list table or limit table. (Softkey labels can be plotted under the control of an external controller. Refer to the *Introductory Programming Guide*.)

[PLOT MKR ON off] (PMKRON, PMKROFF) specifies whether the markers and marker values are to be drawn (on) or not drawn (off) on the plot.

[SCALE PLOT] (SCAPFULL, SCAPGRAT) provides two selections for plot scale, **[FULL]** and **[GRAT]**. **[FULL]** is the normal scale selection for plotting on blank paper, and includes space for all display annotations such as marker values, stimulus values, etc. The entire CRT display fits within the user-defined boundaries of P1 and P2 on the plotter, while maintaining the exact same aspect ratio as the CRT display.

With the selection of **[GRAT]**, the horizontal and vertical scale are expanded or reduced so that the graticule lower left and upper right corners exactly correspond to the user-defined P1 and P2 scaling points on the plotter. This is convenient for plotting on preprinted rectangular or polar forms (for example, on a Smith chart).

To plot on a rectangular preprinted graticule, set P1 of the plotter at the lower left corner of the preprinted graticule, and set P2 at the upper right corner.

To plot on a polar format, set P1 to either the left (or bottom) end point of a diameter and P2 to the right (or top) end point. The analyzer will then compute and set new P1 and P2 values to obtain the current circularity. If P1 and P2 are set to within 10% of already being a perfect square, the analyzer will not change the boundaries but will distort the circles to fit the user-defined boundaries.

The procedure for plotting on a Smith chart format depends on the plotter capabilities. Some HP plotters have a 90° rotate feature that enables plotting on a portrait (vertical) format rather than a landscape (horizontal) format. Since most Smith charts are printed in portrait format, this rotate feature should be used prior to setting the P1 and P2 points as described above for a polar format.

[PLOT SPEED] (PLOSFAST, PLOSSLOW) provides two plot speeds, **[FAST]** and **[SLOW]**. Fast is the proper plot speed for normal plotting. Slow plot speed is used for plotting directly on transparencies: the slower speed provides a more consistent line width. A color plot can be prepared directly on a transparency so that the color is not lost in converting a paper plot to a transparency.

[RETURN] goes back to the copy menu.

Configure Plot Menu

This menu is used to select the pens to be used for plotting different elements of a plot, and the line types for the data and memory traces.

Pen numbers 0 through 10 can be selected (0 indicates no pen). It is possible to select a pen number higher than the number of pens in the plotter used. The convention in most Hewlett-Packard plotters is that when the pen number count reaches its maximum number it starts again at 1. Thus in a 4-pen plotter, pen number 5 actually calls pen number 1.

The default pen numbers for the different plot elements vary between channels 1 and 2, so that when a color plotter is used the plots for the two channels can be identified quickly by their colors.

Line types 0 through 10 can be selected. The line types depend on the model of plotter used. In general, however, line type 0 specifies dots only at the points that are plotted; line types 1 through 6 specify broken lines with different spacing; and lines 7 through 10 are solid lines. Refer to the plotter manual for specific line type information.

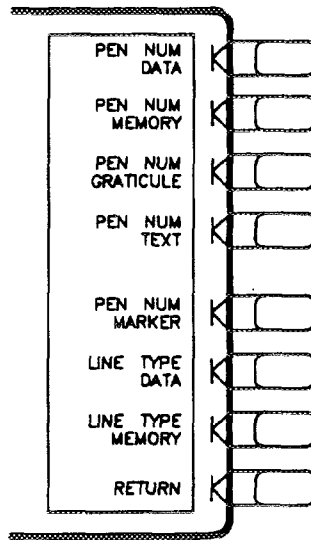

Figure 9-6. Configure Plot Menu

[PEN NUM DATA] (PENNDATA) selects the number of the pen to plot the data trace. The default pen for channel 1 is pen number 1, and for channel 2 is pen number 2.

[PEN NUM MEMORY] (PENMEMO) selects the number of the pen to plot the memory trace. The default pen for channel 1 is pen number 1, and for channel 2 is pen number 2.

[PEN NUM GRATICULE] (PENNGRAT) selects the pen number for plotting the graticule. The default pen for channel 1 is pen number 3, and for channel 2 is pen number 4.

[PEN NUM TEXT] (PENNTXT) selects the pen number for plotting the text. The default pen for channel 1 is pen number 1, and for channel 2 is pen number 2.

[PEN NUM MARKER] (PENMARK) selects the pen number for plotting both the markers and the marker values. The default pen for channel 1 is pen number 5, and for channel 2 is pen number 6.

[LINE TYPE DATA] (LINTDATA) selects the line type for the data trace plot. The default line type is 7, which is a solid unbroken line.

[LINE TYPE MEMORY] (LINTMEMO) selects the line type for the memory trace plot. The default line type is 7.

[RETURN] goes back to the copy menu.

Screen Menu

This menu is used in conjunction with the **[LIST VALUES]** and **[OP PARAM (MKRS ETC)]** features, to make hard copy listings of the tables displayed on the screen. To make copies from the front panel, make sure that the analyzer is in system controller or pass control mode (see Chapter 7).

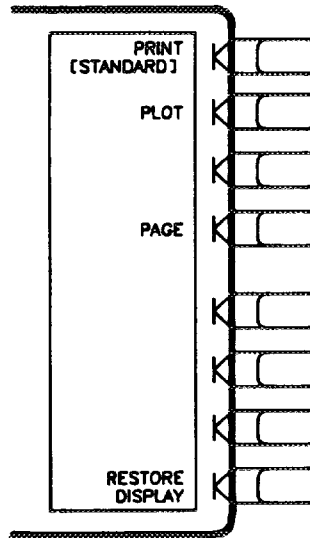

Figure 9-7. Screen Menu

[PRINT [STANDARD]] (PRINALL) copies one page of the tabular listings to a compatible HP graphics printer connected to the analyzer over HP-IB. Either **[STANDARD]**, for a black and white printer, or **[COLOR]**, for a color printer, is shown in brackets. This identifies which printer was selected as the default in the print/plot setups menu. The default setting at power on is standard. Default text for a color printer is black.

[PLOT] (PLOT) makes a hard copy plot of one page of the tabular listing on the CRT, using a compatible HP plotter connected to the analyzer through HP-IB. This method is appropriate when speed of output is not a critical factor.

[PAGE] (NEXP) displays the next page of information in a tabular listing onto the CRT.

[RESTORE DISPLAY] (RESD) turns off the tabular listing and returns the measurement display to the screen.



Chapter 10. Saving Instrument States

CHAPTER CONTENTS

10-1	Introduction	10-9	Title Register Menu
10-1	Types Of Memory	10-10	Title Menu
10-2	Instrument States	10-11	Store File Menu
10-2	Memory Requirements	10-12	Define Store Menu
10-4	Internal Save	10-13	Purge File Menu
10-5	External Store	10-14	Disk Menu
10-5	[SAVE] And [RECALL] Keys	10-15	Initialize Menu
10-7	Save Menu	10-16	Title File Menu
10-8	Clear Register Menu	10-17	Recall Menu
		10-18	Load File Menu

INTRODUCTION

The analyzer has the capability of saving complete instrument states for later retrieval. It has five internal registers for this purpose, and can use direct disk access as an extension to internal memory. This chapter discusses instrument state definition, memory allocation, and internal and external memory storage. Refer to the *HP-IB Programming Guide* for information on external disk storage using a computer controller. Refer to Chapter 13 for information on saving and recalling keystroke sequences.

TYPES OF MEMORY

The analyzer can utilize three types of memory to store instrument states:

- **Volatile Memory.** This is dynamic read/write memory, containing the current instrument state, calibration sets, and the variables listed in Table 10-2. It is cleared upon power cycle to the instrument and, except as noted, upon instrument preset.
- **Non-Volatile Memory.** This is CMOS read/write memory, providing short term (minimum 72 hour) storage of data when line power to the instrument is turned off.
- **External Memory.** This utilizes disk media for unlimited storage of instrument states, as well as calibration and measurement data.

Table 10-1 lists the information that is or can be stored in each type of memory.

Table 10-1. Memory Usage

Volatile Memory (see Table 10-2)	Non-Volatile Memory	External Memory
User graphics (16 Kbytes)	Five learn string registers	Instrument states
Calibration data	CRT focus and intensity defaults	Calibration sets
Current instrument state	HP-IB configuration	Measurement data
Data processing and display	User calibration kit definition	
5 keystroke sequences	Power sensor cal factor and loss tables	

INSTRUMENT STATES

An instrument state consists of all the stimulus and response parameters that set up the analyzer to make a specific measurement. This part of the instrument state is called the learn string and, when saved, is saved to non-volatile memory. (Power sensor cal factor and loss tables are independent of the instrument state, although they are also stored in non-volatile memory.)

The learn string is an encoded array containing only the data needed to re-create the state. For example, to re-create a frequency list the analyzer only needs to save the start frequency, frequency span, and number of points in each segment. Each point is not recorded. Thus the size of the learn string is not proportional to the number of points in the sweep.

An instrument state also includes calibration data and memory traces, which do vary in size with the number of points.

NOTE: Calibration data and memory traces are stored in *volatile* memory. While this data will survive an instrument preset if it has been saved, it is *lost* when line power to the instrument is turned off.

MEMORY REQUIREMENTS

Because instrument states can be of varying complexities, it is possible to fill the available internal memory with less than five states. Also, it is possible to fill memory with instrument states and prevent such memory-intensive functions as two-port error correction, interpolated error correction, 1601 measurement points, or time domain (option 010).

Calibration sets compete with other instrument processes for volatile memory space. Table 10-2 contains the memory requirements of calibration arrays and other functions such as list frequency mode and limit testing. As you turn on more functions, it is very likely that more memory space is being used. Use Table 10-2 to approximate available space. Following Table 10-2, examples are given of different instrument states and their memory requirements.

Table 10-2. User Allocatable Memory (\cong 960 Kbytes Total) (1 of 2)

Variable	Data Length (Bytes)	Approximate Total (Bytes)			
		401 pts	801 pts	1601 pts	
		1 chan		1 chan	2 chans
Calibration Arrays					
Response	$N \times 6 + 52$	2.5k	5k	10k	19k
Response and Isolation	$N \times 6 \times 2 + 52$	5k	10k	19k	38k
1-Port	$N \times 6 \times 3 + 52$	7k	14k	29k	58k
2-Port	$N \times 6 \times 12 + 52$	29k	58k	115k	230k
Interpolated Cal	Same as above in addition to regular cal				
Power Meter Cal ¹	$N \times 2 + 208$	1k	1.8k	3.4k	6.6k
Measurement Data					
Raw Data ¹	$N \times 6 + 52$	2.5k	4.9k	9.7k	19k
Plus 2-Port Cal	$N \times 6 \times 3 + 52$	7.3k	14.5k	29k	58k
Data Array ¹	$N \times 6 + 52$	2.5k	4.9k	9.7k	19k
Formatted Array ¹	$N \times 6 + 52$	2.5k	4.9k	9.7k	19k
Memory Array ¹	$N \times 6 + 52$	2.5k	4.9k	9.7k	19k
Scratchpad Array ²	$N \times 6 + 52$	2.5k	4.9k	9.7k	19k

Table 10-2. User Allocatable Memory (≈ 960 Kbytes Total) (2 of 2)

Variable	Data Length (Bytes)	Approximate Total (Bytes)			
		401 pts	801 pts	1601 pts	
		1 chan		1 chan	2 chans
Operating Modes					
Sampler Correction Arrays ¹	N x 2	0.8k	1.6k	3.2k	6.4k
With 2-Port Cal	N x 4	1.6k	3.2k	6.4k	12.8k
In Frequency List Mode	N x 4	1.6k	3.2k	6.4k	12.8k
Freq List + 2-Port	N x 4 x 2	3.2k	6.4k	12.8k	25.6k
Frequency List Mode ¹	N x 12	4.8k	9.6k	19k	38k
Log Frequency Mode ¹	N x 12	4.8k	9.6k	19k	38k
Smoothing on ¹ (20% aperture, 1601 points)	2000	2k	4k	2k	4k
Print/Plot Buffer ³ (in addition to trace, graticule, limit lines, etc.)		32k	32k	32k	32k
Sequencing (5 of 2 Kbytes each)		10k	10k	10k	10k
Time Domain FFT Array					
≤ 51 points	128 x 6 = 0.8k				
101 points	256 x 6 = 1.5k				
201 points	512 x 6 = 3k				
401 points	1024 x 6	6k			
801 points	2048 x 6		12.3k		
1601 points	2048 x 6			12.3k	24.6k
Window & Chirp Array	N x 4 + FFT array	6.4k	13k	18k	37k
Gating Array	$\approx 5/3$ x FFT array	8k	16k	20k	41k
Notes:					
N = number of points					
1. This variable is allocated once per active channel.					
2. Insufficient memory for allocation of this array is not fatal. The array is used to recalculate the data for display any time formatting factors are changed. If sufficient memory is not allocated, trace data will not be redisplayed after a scaling change until a new sweep occurs.					
3. Insufficient memory for allocation of this array is not fatal, but instrument operation cannot be continued while printing or plotting is in progress.					

Memory Allocation Examples

The following examples show the basic memory requirements of various memory-intensive instrument states, and the extra memory needed as features are added. These examples assume that no other instrument states or calibration sets are saved.

	Total (Bytes)
<ul style="list-style-type: none"> ● 401 points, 2 channels, full 2-port cal, no interpolated cal, no time domain, no list mode, no memory arrays 	93k
add memory trace	100k
add interpolated cal	158k
add time domain, with windowing and gating	199k
add frequency list mode	215k
<ul style="list-style-type: none"> ● 401 points, 1 channel, full 2-port interpolated cal with original cal arrays at 1601 points, no time domain, no list mode, no memory arrays 	159k
add memory trace	162k
add frequency list mode	169k
add time domain, with windowing and gating	189k
all of the above on both channels	378k
<ul style="list-style-type: none"> ● 801 points, 1 channel, full 2-port cal, no interpolated cal, no time domain, no list mode, no memory arrays 	93k
add memory trace	100k
add interpolated cal	158k
add time domain, with windowing and gating	199k
add frequency list mode	212k
all of the above on both channels	418k
<ul style="list-style-type: none"> ● 1601 points, 1 channel, full 2-port cal, no interpolated cal, no time domain, no list mode, no memory arrays 	183k
add memory trace	196k
add interpolated cal	311k
add time domain, with windowing and gating	361k
add list mode	387k
all of the above on both channels	773k

INTERNAL SAVE

A maximum of six instrument states can reside in internal memory at any one time: five saved states and the active instrument state. Up to 12 calibrations can exist if they are saved at the end of the calibration procedure (the actual number may be limited by available memory). Remember, however, that calibrations are lost when instrument power is turned off.

Calibration sets are linked to the instrument state and measurement parameter for which the calibration was done. Therefore a saved calibration can be used for multiple instrument states as long as the measurement parameter, frequency range, and number of points are the same. A full 2-port calibration is valid for any S-parameter measurement with the same frequency range and number of points. When an instrument state is deleted from memory (see [CLEAR REGISTER]), the associated calibration set is also deleted.

If a measurement is saved with calibration and interpolated calibration on, it will be restored with interpolated calibration on.

EXTERNAL STORE

When the analyzer is in system controller mode or pass control mode, it can access an external CS80 disk drive such as the HP 9122. Storing to disk records not only the instrument state, but also calibration sets and measurement data (see [DEFINE STORE]).

The analyzer uses one file name per stored instrument state when communicating with the user via the front panel display. In reality, several files are actually stored to the disk when an instrument state is stored. Thus, when the disk catalog is accessed from a remote system controller, the directory will show several files associated with a particular saved state. The maximum number of files that can be stored on a disk depends on the directory size: the default is 256. Refer to the *HP-IB Programming Guide* for further information.

A disk file created by the analyzer appends a suffix to the file name. (This is used by an external controller for cataloguing files, and is not visible to a local user.) The suffix consists of one or two characters: the first character is the file type and the second is a data index. The *HP-IB Quick Reference* includes a list of the characters used in file name suffixes, and their meanings.

If correction is on at the time of an external store, the calibration set is stored to disk. (Note that inactive calibrations are not stored to disk.) When an instrument state is loaded into the analyzer from disk, the learn string is restored first. If correction is on for the loaded state, the analyzer will load a calibration set from disk that carries the same title as the one stored for the instrument state.

If an instrument state is stored with interpolated calibration on, the restored instrument state will be interpolated.

NOTE: A calibration stored from one instrument and recalled by a different one will be invalid. To ensure maximum accuracy, always recalibrate in these circumstances.

NOTE: No record is kept in memory of the temperature when a calibration set was stored. Instrument characteristics change as a function of temperature, and a calibration stored at one temperature may be inaccurate if recalled and used at a different temperature. Refer to the *Specifications* tables in the *General Information* section for allowable temperature ranges for individual specifications.

NOTE: The HP 8753C can read disk files stored by the HP 8753B. A disk file translator is available to make HP 8753A disk files compatible with HP 8753B files. These files can then be read by the HP 8753C. Contact your local Hewlett-Packard sales/service office for a copy of this disk file translator.

[SAVE] AND [RECALL] KEYS

The HP-IB programming command is shown in parenthesis following the key or softkey.

The [SAVE] key provides access to all the menus used for saving instrument states in internal memory and for storing to external disk. This includes the menus used to define titles for internal registers and external disk files, to define the content of disk files, to initialize disks for storage, and to clear data from the registers or purge files from disk.

The [RECALL] key leads to the menus that recall the contents of internal registers, or load files from external disk back into the analyzer.

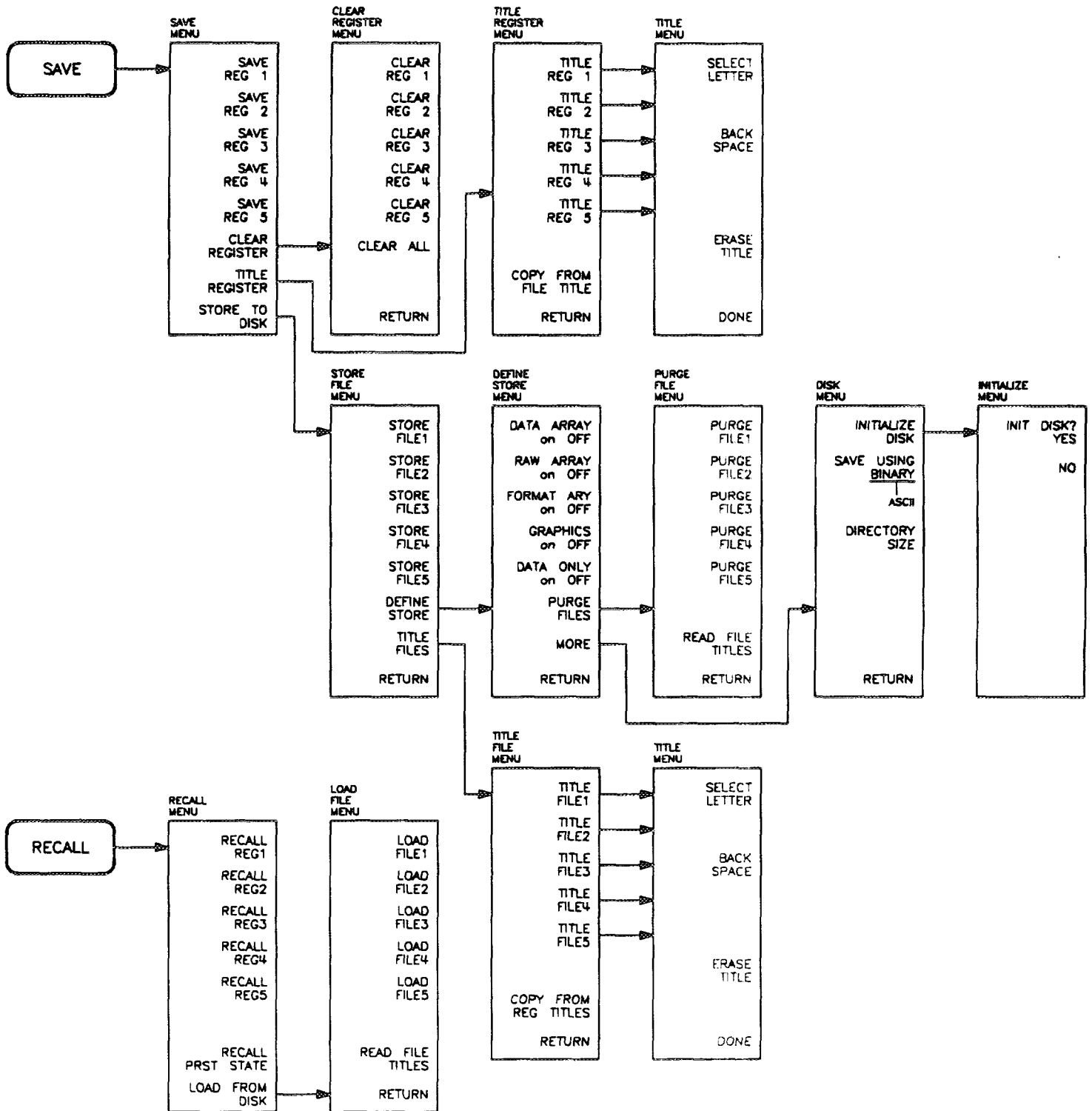

Figure 10-1. Softkey Menus Accessed from the [SAVE] and [RECALL] Keys

Save Menu

This menu (Figure 10-2) selects an internal memory register to save the current instrument state. If a register contains a previously saved instrument state, the softkey label changes to **[RESAVE]**. This is intended to prevent inadvertent destruction of saved states. Pressing **[RESAVE]** removes the contents of the register and saves the new instrument state.

NOTE: Modified colors are *not* part of the instrument state.

This also leads to the series of menus for external disk storage.

The default titles for the save registers are REG1 through REG5, but these titles can be modified using the title register menu and the title menu.

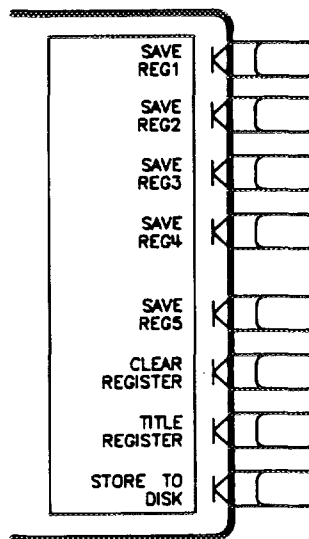

Figure 10-2. Save Menu

[SAVE REG1] (SAVE1) saves the present instrument state in an internal register titled REG1.

[SAVE REG2] (SAVE2) saves the present instrument state in internal register REG2.

[SAVE REG3] (SAVE3) saves the present instrument state in internal register REG3.

[SAVE REG4] (SAVE4) saves the present instrument state in internal register REG4.

[SAVE REG5] (SAVE5) saves the present instrument state in internal register REG5.

[CLEAR REGISTER] leads to the clear register menu, described later.

[TITLE REGISTER] leads to the title register menu, where the default register titles can be modified.

[STORE TO DISC] leads to the store file menu, which introduces a series of menus for disk storage.

Clear Register Menu

This menu (Figure 10-3) allows unused instrument states to be cleared from save registers, making the assigned memory available for other uses. When an instrument state is deleted from memory, the associated calibration set is also deleted. You can choose to selectively clear individual registers, or clear all registers with one keystroke.

Clearing of registers is performed internally with 100 alternating 0 and 1 rewrite operations over the entire non-volatile portion of the specified register memory.

Only registers that have instrument states previously stored in them are listed in this menu.

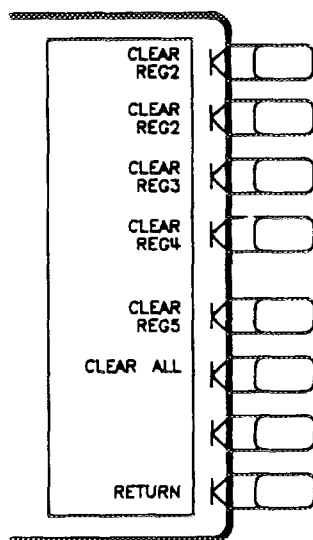

Figure 10-3. Clear Register Menu

[CLEAR REG1] (CLEA1) clears a previously saved instrument state from register 1.

[CLEAR REG2] (CLEA2) clears a saved instrument state from register 2.

[CLEAR REG3] (CLEA3) clears a saved instrument state from register 3.

[CLEAR REG4] (CLEA4) clears a saved instrument state from register 4.

[CLEAR REG5] (CLEA5) clears a saved instrument state from register 5.

[CLEAR ALL] (CLEARALL) clears all instrument states.

[RETURN] goes back to the save menu.

Title Register Menu

This menu can be used to select a register to be retitled. All registers are listed, regardless of whether or not they contain saved instrument states. When any of the title register softkeys is pressed, the title menu is presented and the character set is displayed in the active entry area.

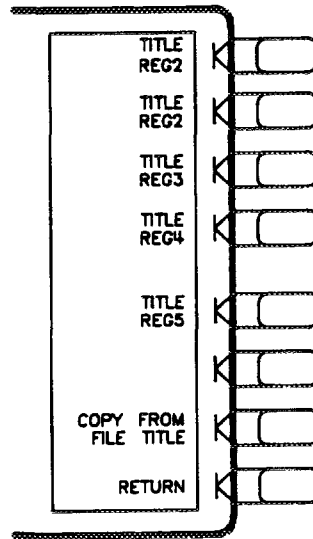

Figure 10-4. Title Register Menu

[TITLE REG1] (TITR1) selects register 1 to be retitled and presents the title menu and the character set.

[TITLE REG2] (TITR2) selects register 2 to be retitled.

[TITLE REG3] (TITR3) selects register 3 to be retitled.

[TITLE REG4] (TITR4) selects register 4 to be retitled.

[TITLE REG5] (TITR5) selects register 5 to be retitled.

[COPY FROM FILE TITLE] (COPYFRFT) renames the internal registers to match the current names of the store files. For example, the default names of the internal registers are REG1 through REG5. The default names of the store files are FILE1 through FILE5. Pressing this key would rename the internal registers FILE1 through FILE5. If you have modified the names of the store files, the modified names would be copied as the internal save register names.

[RETURN] goes back to the save menu.

Title Menu

Use this menu (Figure 10-5) to define a title for the register selected in the title register menu. The title replaces the default register title in the softkey label, and is recalled with the saved instrument state.

The register title is limited to eight characters. If more than eight characters are selected, the last character is repeatedly written over. The title must be all alpha-numeric, and must start with an alpha character. If the first character selected is not an alpha character, the message "CAUTION: FIRST CHARACTER MUST BE A LETTER" is displayed when the **[DONE]** key is pressed. No special characters or spaces are allowed. If a disallowed character is selected, the message "CAUTION: ONLY LETTERS & NUMBERS ARE ALLOWED" is displayed. (The special characters are used only for the display title, described in Chapter 4.)

The save register title is independent of the display title, which is also saved and recalled as part of the display.

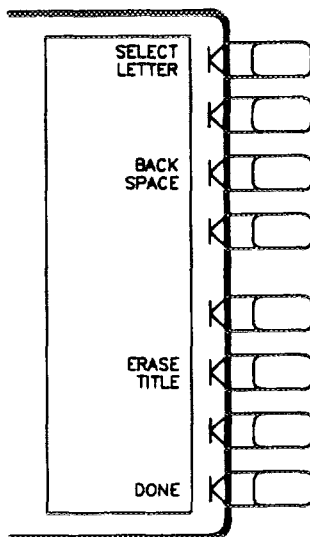

Figure 10-5. Title Menu

[SELECT LETTER]. The active entry area displays the letters of the alphabet, digits 0 through 9, and mathematical symbols. The mathematical symbols are not used in register titles. To define a title, rotate the knob until the arrow \uparrow points at the first letter, then press **[SELECT LETTER]**. Repeat this until the complete title is defined, for a maximum of eight characters. As each character is selected, it is appended to the title at the top left corner of the graticule.

[BACK SPACE] deletes the last character entered.

[ERASE TITLE] deletes the entire register title.

[DONE] terminates the title entry, and returns to the title register menu. The new title appears in the softkey label in all applicable menus.

Store File Menu

This menu (Figure 10-6) is used to store instrument states to an external disk rather than to internal memory registers. The analyzer can use HP-IB to store directly to a compatible disk drive, without the use of an external controller. Refer to the *General Information* section of this manual for information about compatible disk drives. Refer to the first part of this chapter for information about disk storage.

To store information on an external disk from the front panel when there is no other controller on the bus, the analyzer must be in system controller HP-IB mode. To take control from the computer and initiate a store operation, the analyzer must be in pass control mode. If it is not in one of these modes, the message "SYST CTRL OR PASS CTRL IN LOCAL MENU" is displayed. Refer to [LOCAL] Key in Chapter 7 for information on HP-IB controller modes and setting addresses.

If you attempt to store a file and the message "CAUTION: DISK: not on, not connected, wrong addr" is displayed, check the disk drive line power and HP-IB cable connection. Also make sure that the HP-IB address of the disk drive matches the address set in the address menu (see Chapter 7).

The analyzer uses one file name per instrument state for communicating with the user via the front panel display. In reality, several files might actually be stored to the disk when an instrument state is stored, depending on the functions being stored. This does not affect operation from the front panel. The default names for the stored files are FILE1 through FILE5. These file names can be modified using the title file menu.

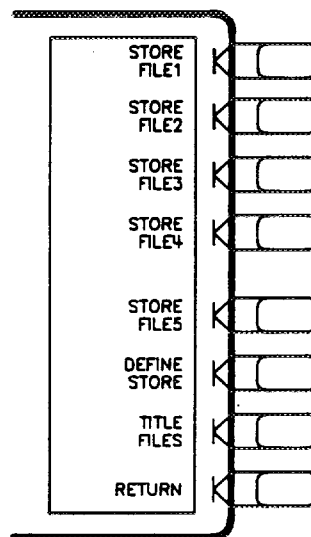

Figure 10-6. Store File Menu

[STORE FILE1] (STOR1) stores the current instrument state in disk file 1, together with any data specified in the define store menu (see next page).

[STORE FILE2] (STOR2) stores the current instrument state and specified data in file 2.

[STORE FILE3] (STOR3) stores the current instrument state and specified data in file 3.

[STORE FILE4] (STOR4) stores the current instrument state and specified data in file 4.

[STORE FILE5] (STOR5) stores the current instrument state and specified data in file 5.

[DEFINE STORE] leads to the define store menu. Use this menu to specify the data to be stored on disk in addition to the instrument state.

[TITLE FILES] leads to the title file menu, where the default file titles can be modified.

[RETURN] goes back to the save menu.

Define Store Menu

Data and user graphics can be stored on disk along with the basic instrument state. The data can be stored from different points in the data processing flow. It is possible to store raw, error-corrected, or formatted data, or any combination of the three. This menu allows the option of specifying what data is to be stored. Refer to *Data Processing Flow* in Chapter 1 for more information about data arrays and the sequence of data processing events.

If a memory trace exists and is displayed, either alone or in a memory math function, it is automatically stored with the data.

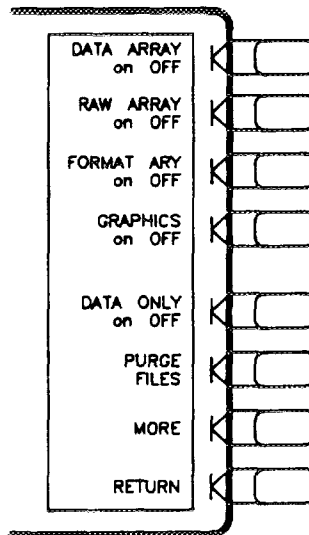

Figure 10-7. Define Store Menu

[DATA ARRAY on OFF] (EXTMDATAON, EXTMDATAOFF) specifies whether or not to store the error-corrected data on disk with the instrument state.

[RAW ARRAY on OFF] (EXTMRAWON, EXTMRAWOFF) specifies whether or not to store the raw data (ratioed and averaged) on disk with the instrument state.

[FORMAT ARY on OFF] (EXTMFORMON, EXTMFORMOFF) specifies whether or not to store the formatted data on disk with the instrument state.

[GRAPHICS on OFF] (EXTMGRAPON, EXTMGRAPOFF) specifies whether or not to store display graphics on disk with the instrument state.

[DATA ONLY on OFF] stores only the measurement data of the device under test. The instrument state and calibration are not stored. This is faster than storing with the instrument state, and uses less disk space. It is intended for use in archiving data that will later be used with an external controller, and cannot be read back by the analyzer.

[PURGE FILES] leads to the purge files menu, which is used to remove the information stored on an external disk.

[MORE] leads to the disk menu, where additional parameters are defined for storing to disk. This in turn leads to the initialize menu.

[RETURN] goes back to the store file menu.

Purge File Menu

This menu is used to remove (purge) stored information from a disk. When the purge file menu is entered, the file titles currently in analyzer memory are displayed. (File titles are stored in non-volatile memory.) These titles may or may not reside on the disk currently being used. The file titles can be updated to match the files on disk by reading the disk's directory with the **[READ FILE TITLES]** key.

The purge file menu is the external storage equivalent of the clear register menu.

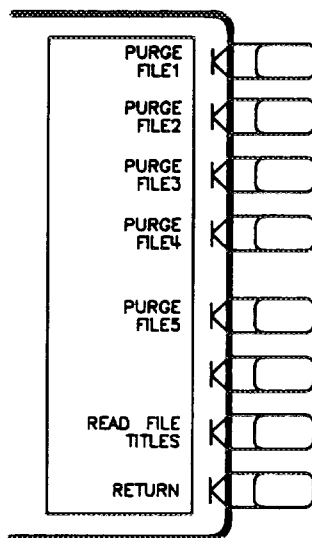

Figure 10-8. Purge File Menu

[PURGE FILE1] (PURG1) purges FILE1 from the disk. If no file of that name exists on the disk, the message "CAUTION: NO FILE(S) FOUND ON DISK" will appear.

[PURGE FILE2] (PURG2) purges FILE2 from the disk.

[PURGE FILE3] (PURG3) purges FILE3 from the disk.

[PURGE FILE4] (PURG4) purges FILE4 from the disk.

[PURGE FILE5] (PURG5) purges FILE5 from the disk.

[READ FILE TITLES] (REFT) searches the directory of the disk for file names recognized as belonging to an instrument state, and displays them in the softkey labels. No more than five titles are displayed at one time. If there are more than five, repeatedly pressing this key causes the next five to be displayed. If there are fewer than five, the remaining softkey labels are blanked.

[RETURN] goes back to the define store menu.

Disk Menu

This menu provides additional parameters for defining data storage. Use this menu to select either binary or ASCII format for data storage. The binary file format is the fastest and most compact disk storage format. The ASCII format is used when data will be exchanged with an external computer or other instrument. You can select binary or ASCII file format for the following data types:

- Display Memories.
- Raw Data.
- Corrected Data.
- Formatted Data.
- Calibration Data.

The following files are *always* stored in binary format:

- Instrument State.
- Calibration Kit.
- User Graphics Display.

ASCII files are stored as the "ASCII" file type of the logical interchange format (LIF). The data stored in an ASCII file is stored in "Common Instrumentation Transfer and Interchange File" (CITIFILE) format.

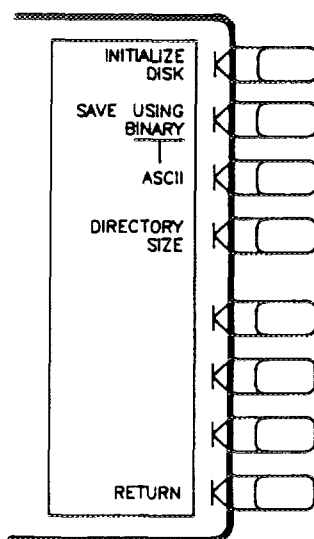

Figure 10-9. Disk Menu

[INITIALIZE DISK] leads to the initialize menu. Before data can be stored on a disk, the disk must be initialized. If you attempt to store without initializing the disk, the message "CAUTION: DISK MEDIUM NOT INITIALIZED" is displayed. The disk format is logical interchange format (LIF).

[SAVE USING BINARY] (SAVUBINA) selects binary format for data storage.

If a disk was formatted with another operating system such as UNIX or MS-DOS, the analyzer will not read from it nor write to it, nor alter it in any way. If a store operation is attempted with such a disk, the message "WRONG DISK FORMAT, INITIALIZE DISK" is displayed.

[ASCII] (SAVUASCI) selects ASCII format for data storage.

[DIRECTORY SIZE] lets you specify the number of directory files to be initialized on a disk. This is particularly useful with a hard disk, where you may want a directory larger than the default 256 files, or with a floppy disk you may want to reduce the directory to allow extra space for data files. The number of directory files must be a multiple of 8. The minimum number is 8, and there is no practical maximum limit. Set the directory size before initializing a disk.

[RETURN] goes back to the define store menu.

Initialize Menu

Initializing a disk prepares it to store data. A disk must be initialized for format compatibility before it can be used for storage. (This is *disk* format: the *data* format is binary or ASCII, as explained previously.) This menu initializes disks using LIF (logical interchange format) to provide compatibility with HP 9000 series 200/300 computers. A disk initialized on one of these computers will work with the analyzer. The recommended interleave factor is 7. Either the Hewlett-Packard black or gray double-sided disks can be used with the HP 9122 disk drive: if high transfer speed is a consideration, gray is recommended. Refer to the *General Information and Specifications* section for information about disks.

Initializing a disk removes all existing data. When this menu is presented, the message "INIT DISK" removes all data from disk" is displayed. If other error messages are encountered, refer to Chapter 12, *Error Messages*, for help.

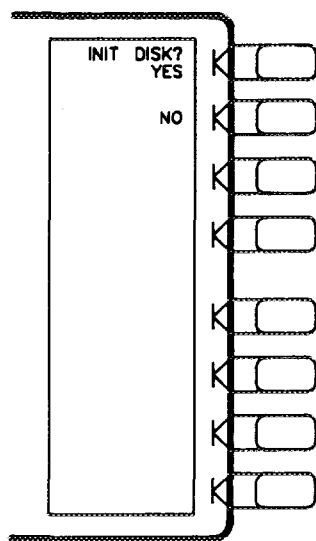

Figure 10-10. Initialize Menu

[INIT DISK? YES] initializes the disk unit number and volume number selected in the HP-IB menu (see Chapter 7), then returns to the disk menu. If more than one hard disk volume is to be initialized, each volume must be selected and initialized individually.

During the initialization process, the message "WAITING FOR DISK" is displayed: this is normal. If the disk is damaged, the message "INITIALIZATION FAILED" is displayed.

[NO] leaves this menu without initializing the disk, and returns to the disk menu.

Title File Menu

This menu (Figure 10-11) is used to select a disk file to be retitled. When the softkey for the selected file is pressed, the title menu is presented and the character set is displayed in the active entry area. The title menu is described earlier in this chapter. The same restrictions apply to file titles as to internal register titles: a file title is limited to eight characters, must be all alpha-numeric, and must begin with an alpha character.

A file title defined with the title menu replaces the default file title in the softkey label, and is stored to disk with the corresponding file.

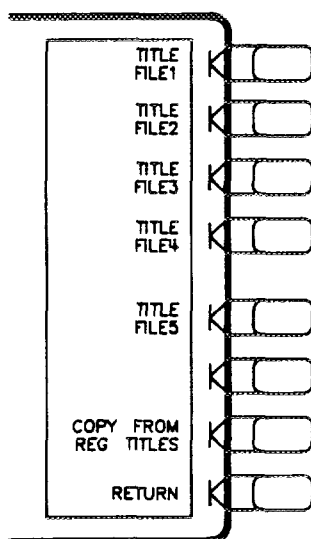

Figure 10-11. Title File Menu

[TITLE FILE1] (TITF1) selects file 1 to be retitled, and leads to the title menu.

[TITLE FILE2] (TITF2) selects file 2 to be retitled.

[TITLE FILE3] (TITF3) selects file 3 to be retitled.

[TITLE FILE4] (TITF4) selects file 4 to be retitled.

[TITLE FILE5] (TITF5) selects file 5 to be retitled.

[COPY FROM REG TITLES] renames the store files to match the current names of the internal registers. (It does not alter the names of any files already stored to disk). For example, the default names of the internal registers are REG1 through REG5. The default file names of the store files are FILE1 through FILE5. Pressing this key would rename the store files REG1 through REG5. If you have modified the names of the internal save registers, the modified names are copied as the store file names.

[RETURN] goes back to the store file menu.

Recall Menu

This menu is used to recall instrument states from internal memory. It is also used to access the load file menu, which loads files from external disk.

When the recall menu is displayed, only the names of registers containing instrument states are displayed in the top five softkey labels. Any register that does not currently contain a saved instrument state has its softkey label blanked.

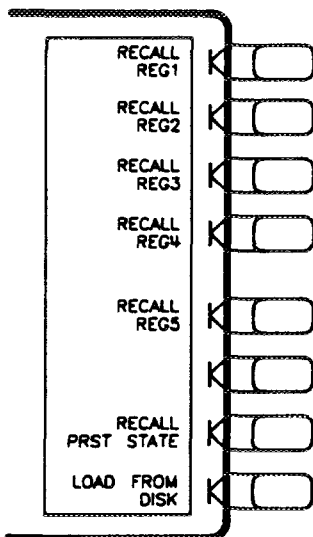

Figure 10-12. Recall Menu

[RECALL REG1] (RECA1) recalls the instrument state saved in register 1. The current instrument state is overwritten.

[RECALL REG2] (RECA2) recalls the instrument state saved in register 2.

[RECALL REG3] (RECA3) recalls the instrument state saved in register 3.

[RECALL REG4] (RECA4) recalls the instrument state saved in register 4.

[RECALL REG5] (RECA5) recalls the instrument state saved in register 5.

[RECALL PRST STATE] is used in conjunction with sequencing, to return the instrument to the known preset state without turning off the sequencing function. This is not the same as pressing the **[PRESET]** key: no preset tests are run, and the HP-IB and sequencing activities are not changed.

[LOAD FROM DISK] accesses the load file menu. Use this menu to load instrument states previously stored to disk.

Load File Menu

This menu (Figure 10-13) is used to search the directory of a disk and load previously stored instrument state files.

There are three ways to locate a file on disk.

1. The analyzer remembers the names of the last five files it previously found on any disk. (File titles are stored in non-volatile memory.) Therefore, when you enter this menu, the file titles in memory will appear in the top five softkeys, whether or not they reside on the disk currently in the drive.
2. The **[READ FILE TITLES]** key in this menu causes the analyzer to search the directory of the current disk and display any file titles recognized as compatible.
3. From the store file menu, use the **[TITLE FILES]** key to title a store file softkey with the name of the file you want to load. Return to the load file menu. The title you just created will appear in one of the load file softkey labels. Press that softkey. If the file does not exist, the message "CAUTION: NO FILE(S) FOUND ON DISK" will be displayed. This method is useful only if you know the exact name of the instrument state to be loaded. Using **[READ FILE TITLES]** is a more efficient method of finding file names, unless a large number of instrument states has been stored to the disk.

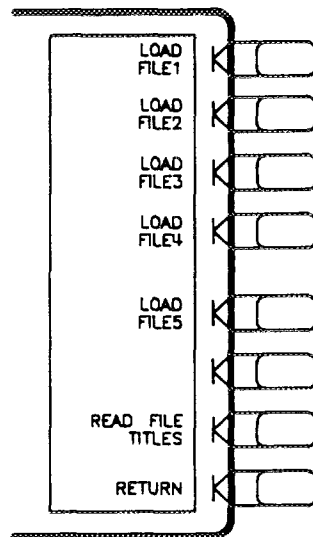

Figure 10-13. Load File Menu

[LOAD FILE1] (LOAD1) loads the instrument state contained in FILE1. The current instrument state is overwritten.

[LOAD FILE2] (LOAD2) loads the instrument state contained in FILE2.

[LOAD FILE3] (LOAD3) loads the instrument state contained in FILE3.

[LOAD FILE4] (LOAD4) loads the instrument state contained in FILE4.

[LOAD FILE5] (LOAD5) loads the instrument state contained in FILE5.

[READ FILE TITLES] (REFT) searches the directory of the disk for file names recognized as belonging to an instrument state. No more than five titles are displayed at one time. If there are more than five, repeatedly pressing this key causes the next five to be displayed. If there are fewer than five, the remaining softkey labels are blanked.

[RETURN] goes back to the recall menu.

Chapter 11. HP-IB Remote Programming

CHAPTER CONTENTS

- 11-1 Introduction
- 11-2 How HP-IB Works
- 11-3 HP-IB Bus Structure
- 11-5 HP-IB Requirements
- 11-5 Analyzer HP-IB Capabilities
- 11-6 Bus Mode
- 11-7 Setting Addresses
- 11-7 Valid Characters
- 11-7 Code Naming Convention
- 11-8 Units and Terminators
- 11-8 HP-IB Debug Mode
- 11-8 CRT Graphics

INTRODUCTION

The analyzer is factory-equipped with a remote programming digital interface using the Hewlett-Packard Interface Bus (HP-IB). (HP-IB is Hewlett-Packard's hardware, software, documentation, and support for IEEE 488.1 and IEC-625, worldwide standards for interfacing instruments.) This allows the analyzer to be controlled by an external computer that sends commands or instructions to and receives data from the analyzer using the HP-IB. In this way, a remote operator has the same control of the instrument available to a local operator from the front panel, except for control of the line power switch.

In addition, the analyzer itself can use HP-IB to directly control compatible peripherals, without the use of an external controller. It can output measurement results directly to a compatible printer or plotter, or store instrument states to a compatible disk drive.

This chapter provides an overview of HP-IB operation. Chapter 7 provides information on different controller modes, and on setting up the analyzer as a controller of peripherals. Chapters 9 and 10 explain how to use the analyzer as a controller to print, plot, and store to an external disk. In addition, HP-IB equivalent mnemonics for front panel functions are provided in parentheses throughout this *Reference*.

More complete information on programming the analyzer remotely over HP-IB is provided in the following documents:

- *HP-IB Programming Guide for the HP 8752A and HP 8753C Using the HP 9000 Series 200/300 Desktop Computer (BASIC)*. This is a tutorial introduction to remote operation of the analyzer using an HP 9000 series 200 or 300 computer. It includes examples of remote measurements using BASIC programming. These examples are also stored on the example programs disk provided with the analyzer. The *HP-IB Programming Guide* assumes familiarity with front panel operation of the instrument.

- *HP-IB Quick Reference for the HP 8700-Series Analyzers*. This is a complete reference summary for remote operation of the analyzer with a controller. It includes both functional and alphabetical lists of all analyzer HP-IB commands. This guide is intended for use by those familiar with HP-IB programming and the basic functions of the analyzer.

A complete general description of the HP-IB is available in *Tutorial Description of the Hewlett-Packard Interface Bus*, HP publication 5952-0156. For more information on the IEEE-488.1 standard refer to *IEEE Standard Digital Interface for Programmable Instrumentation*, published by the Institute of Electrical and Electronics Engineers, Inc., 345 East 47th Street, New York, New York 10017.

HOW HP-IB WORKS

The HP-IB uses a party-line bus structure in which up to 15 devices can be connected on one contiguous bus. The interface consists of 16 signal lines and 8 ground lines in a shielded cable. With this cabling system, many different types of devices including instruments, computers, plotters, printers, and disk drives can be connected in parallel.

Every HP-IB device must be capable of performing one or more of the following interface functions:

Talker

A talker is a device capable of sending device-dependent data when addressed to talk. There can be only one talker at any given time. Examples of this type of device are voltmeters, counters, and tape readers. The analyzer is a talker when it sends trace data or marker information over the bus.

Listener

A listener is a device capable of receiving device-dependent data when addressed to listen. There can be any number of listeners at any given time. Examples of this type of device are printers, power supplies, and signal generators. The analyzer is a listener when it is controlled over the bus by a computer.

Controller

A controller is a device capable of managing the operation of the bus and addressing talkers and listeners. There can be only one active controller at any time. Examples of controllers include desktop computers and minicomputers. In a multiple-controller system, active control can be passed between controllers, but there can only be one *system controller*, which acts as the master, and can regain active control at any time. The analyzer is an active controller when it plots, prints, or stores to an external disk drive in the pass control mode. The analyzer is a system controller when it is in the system controller mode. These modes are discussed in more detail in Chapter 7 under *HP-IB Menu*.

HP-IB BUS STRUCTURE

Data Bus

The data bus consists of eight bidirectional lines that are used to transfer data from one device to another. Programming commands and data are typically encoded on these lines in ASCII, although binary encoding is often used to speed up the transfer of large arrays. Both ASCII and binary data formats are available to the analyzer. In addition, every byte transferred over HP-IB undergoes a *handshake* to ensure valid data.

Handshake Lines

A three-line handshake scheme coordinates the transfer of data between talkers and listeners. This technique forces data transfers to occur at the speed of the slowest device, and ensures data integrity in multiple listener transfers. With most computing controllers and instruments, the handshake is performed automatically, which makes it transparent to the programmer.

Control Lines

The data bus also has five control lines that the controller uses both to send bus commands and to address devices.

IFC. Interface Clear. Only the system controller uses this line. When this line is true (low), all devices (addressed or not) unaddress and go to an idle state.

ATN. Attention. The active controller uses this line to define whether the information on the data bus is a *command* or is *data*. When this line is true (low), the bus is in the command mode and the data lines carry bus commands. When this line is false (high), the bus is in the data mode and the data lines carry device-dependent instructions or data.

SRQ. Service Request. This line is set true (low) when a device requests service: the active controller services the requesting device. The analyzer can be enabled to pull the SRQ line for a variety of reasons.

REN. Remote Enable. Only the system controller uses this line. When this line is set true (low), the bus is in the remote mode, and devices are addressed either to listen or to talk. When the bus is in remote and a device is addressed, it receives instructions from HP-IB rather than from its front panel (the **[LOCAL]** key returns the device to front panel operation). When this line is set false (high), the bus and all devices return to local operation.

EOI. End or Identify. This line is used by a talker to indicate the last data byte in a multiple byte transmission, or by an active controller to initiate a parallel poll sequence. The analyzer recognizes the EOI line as a terminator, and it pulls the EOI line with the last byte of a message output (data, markers, plots, prints, error messages). The analyzer does not respond to parallel poll.

Figure 11-1 illustrates the structure of the HP-IB bus lines.

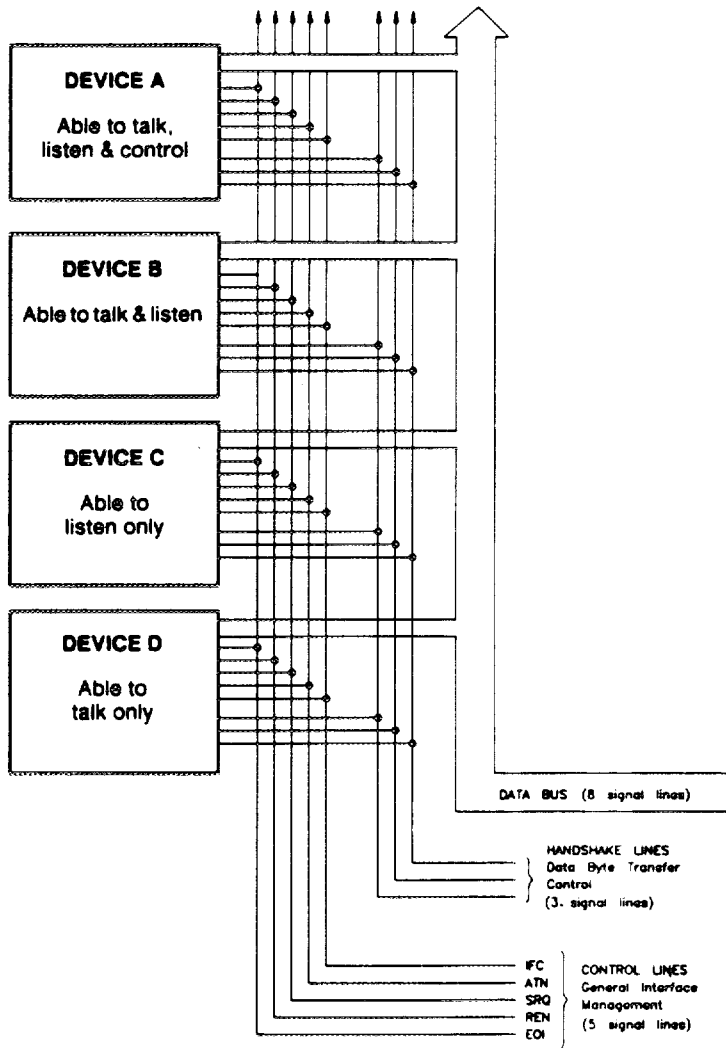

Figure 11-1. HP-IB Structure

HP-IB REQUIREMENTS

Number of Interconnected Devices:	15 maximum.
Interconnection Path/ Maximum Cable Length:	20 metres maximum or 2 metres per device, whichever is less.
Message Transfer Scheme:	Byte serial/ bit parallel asynchronous data transfer using a 3-line handshake system.
Data Rate:	Maximum of 1 megabyte per second over limited distances with tri-state drivers. Actual data rate depends on the transfer rate of the slowest device involved.
Address Capability:	Primary addresses: 31 talk, 31 listen. A maximum of 1 talker and 14 listeners at one time.
Multiple Controller Capability:	In systems with more than one controller (like the analyzer system), only one can be active at a time. The active controller can pass control to another controller, but only the system controller can assume unconditional control. Only one system controller is allowed. The system controller is hard-wired to assume bus control after a power failure.

ANALYZER HP-IB CAPABILITIES

As defined by the IEEE 488.1 standard, the analyzer has the following capabilities:

SH1	Full source handshake.
AH1	Full acceptor handshake.
T6	Basic talker, answers serial poll, unaddresses if MLA is issued. No talk-only mode.
L4	Basic listener, unaddresses if MTA is issued. No listen-only mode.
SR1	Complete service request (SRQ) capabilities.
RL1	Complete remote/local capability including local lockout.
PP0	Does not respond to parallel poll.
DC1	Complete device clear.
DT1	Responds to a group execute trigger in the hold trigger mode.
C1,C2,C3	System controller capabilities in system controller mode.
C10	Pass control capabilities in pass control mode.
E2	Tri-state drivers.

BUS MODE

The analyzer uses a single-bus architecture. The single bus allows both the analyzer and the host controller to have complete access to the peripherals in the system.

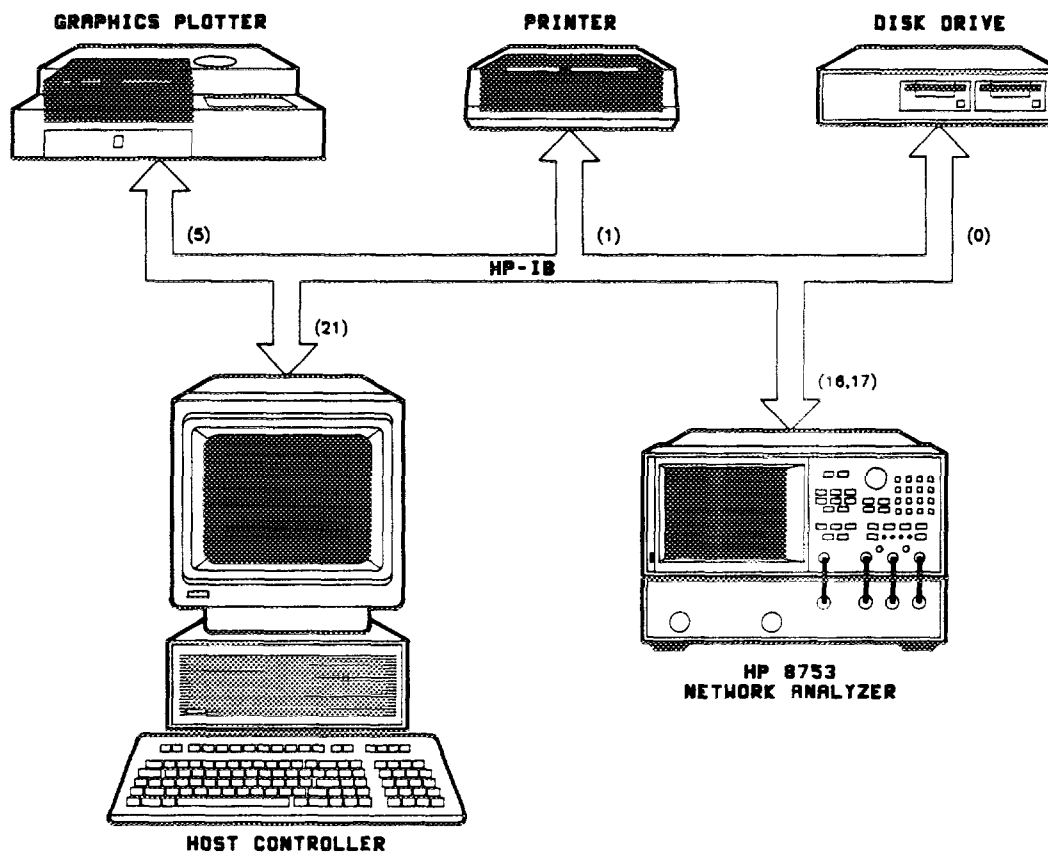

Figure 11-2. Analyzer Single Bus Concept

Three different controller modes are possible, system controller, talker/listener, and pass control.

System Controller. This mode allows the analyzer to control peripherals directly in a stand-alone environment (without an external controller). This mode can only be selected manually from the analyzer front panel. Use this mode for operation when no computer is connected to the analyzer. Do not use this mode for programming.

Talker/Listener. This is the traditional programming mode, in which the computer is involved in all peripheral access operations. Peripheral access (plotting and printing only) is also possible by addressing the analyzer to talk, addressing the peripheral to listen, and placing the HP-IB in the data mode.

Pass Control. This mode allows you to control the analyzer over HP-IB as with the talker/listener mode, and also allows the analyzer to take or pass control in order to plot, print, and access a disk. During the peripheral operation, the host computer is free to perform other internal tasks such as data or display manipulation (the bus is tied up by the analyzer during this time). After a task is completed, the host controller accepts control again when the analyzer returns it.

In general, use the talker/listener mode for programming the analyzer unless you desire direct peripheral access. Preset does not affect the selected bus mode, but the bus mode returns talker/listener if power is cycled.

Chapter 7 explains the three different bus modes in detail, and provides information on setting the correct bus mode. Programming information for talker/listener mode and pass control mode is provided in the *HP-IB Programming Guide*.

SETTING ADDRESSES

In communications through HP-IB, each instrument on the bus is identified by an HP-IB address. This address code must be different for each instrument on the bus. Refer to *Address Menu* in Chapter 7 for information on default addresses, and on setting and changing addresses. These addresses are stored in short-term non-volatile memory and are not affected when you press [PRESET] or cycle the power (although the [PRESET] key must be pressed to implement a change to the analyzer address).

VALID CHARACTERS

The analyzer accepts ASCII letters, numbers, decimal points, +/–, semicolons, quotation marks ("), carriage returns (CR), and linefeeds (LF). Both upper and lower case are acceptable. Leading zeros, spaces, carriage returns, and unnecessary terminators are ignored, except those within a command or appendage. Carriage returns are ignored. An invalid character causes a syntax error. Syntax errors are described in more detail under in the *HP-IB Programming Guide*.

CODE NAMING CONVENTION

The analyzer HP-IB commands are derived from their front panel key titles (where possible), according to the naming convention below.

Convention	Key Title	For HP-IB Code Use	Example
One Word	Power Start	First Four Letters	POWE STAR
Two Words	Electrical Delay Search Right	First Three Letters of First Word First Letter of Second Word	ELED SEAR
Two Words in a Group	Marker →Center Gate →Span	First Four Letters of Both	MARKCENT GATESPAN
Three Words	Cal Kit N 50Ω Pen Num Data	First Three Letters of First Word First Letter of Second Word First Four Letters of Third Word	CALKN50 PENNDATA

Some codes require appendages (on, off, 1, 2, etc.). Codes that have no front panel equivalent are HP-IB only commands, and use a similar convention based on the common name of the function. Where possible, analyzer codes are compatible with HP 8510A/B codes.

Front panel equivalent codes and HP-IB only codes are summarized in the *HP-IB Quick Reference*.

UNITS AND TERMINATORS

The analyzer outputs data in basic units and assumes these basic units when it receives an input, unless the input is otherwise qualified. The basic units and allowable expressions follow; either upper or lower case is acceptable.

Basic Units	Allowable Expressions
Seconds	S
Milliseconds	MS
Microseconds	US
Nanoseconds	NS
Picoseconds	PS
Femtoseconds	FS
Hertz	HZ
Kilohertz	KHZ
Megahertz	MHZ
Gigahertz	GHZ
dB or dBm	DB
Volts	V

Terminators are used to indicate the end of a command to allow the analyzer to recover to the next command in the event of a syntax error. The semicolon is the recommended command terminator. The line feed (LF) character and the HP-IB EOI line can also be used as terminators. The analyzer ignores the carriage return (CR) character.

HP-IB DEBUG MODE

An HP-IB diagnostic feature (debug mode) is available in the HP-IB menu. Activating the debug mode causes the analyzer to scroll incoming HP-IB commands across the display. Nonprintable characters are represented with a π . Any time the analyzer receives a syntax error, the commands halt, and a pointer \wedge indicates the misunderstood character. The *HP-IB Programming Guide* explains how to clear a syntax error.

CRT GRAPHICS

The analyzer CRT can be used as a graphics display for displaying connection diagrams or custom instructions to an operator. The CRT accepts a subset of Hewlett-Packard Graphics Language (HP-GL) commands.

NOTE: The analyzer display occupies an additional address on the HP-IB. Determine the CRT bus address by adding 1 to the analyzer address if the analyzer address is an even number, or subtracting 1 if it is an odd number. Thus the factory default CRT address for graphics is 17.

Chapter 12. Error Messages

CHAPTER CONTENTS

- 12-1 Introduction
- 12-1 Error Messages In Alphabetical Order
- 12-9 Error Messages In Numerical Order

INTRODUCTION

This chapter lists the error messages that may be displayed on the analyzer CRT or transmitted by the instrument over HP-IB. Each error message is accompanied by an explanation, and suggestions are provided to help in solving the problem. Where applicable, references are given to related sections of the operating and service manuals.

When displayed, error messages are usually preceded with the word CAUTION:. That part of the error message has been omitted here for the sake of brevity. Some messages are for information only, and do not indicate an error condition. Two listings are provided: the first is in alphabetical order, and the second in numerical order.

In addition to error messages, instrument status is indicated by status notations in the left margin of the CRT. Examples are “*,” “tsH,” and “P↓.” Sometimes these appear in conjunction with error messages. A complete listing of status notations and their meanings is provided in Chapter 2, *Front Panel and Softkey Operation*.

ERROR MESSAGES IN ALPHABETICAL ORDER

ADDITIONAL STANDARDS NEEDED (error #68). Error correction for the selected calibration class cannot be computed until all the necessary standards have been measured.

ADDRESSED TO TALK WITH NOTHING TO SAY (error #31). An enter command was sent to the analyzer without first requesting data with an appropriate output command (such as OUTPDATA). The analyzer has no data in the output queue to satisfy the request.

AVERAGING INVALID ON NON-RATIO MEASURE (error #13). This error occurs only in single-input measurements. Sweep-to-sweep averaging is valid only for ratioed measurements (A/R, B/R, A/B, and S-parameters). Other noise reduction techniques are available for single input measurements. Refer to *[AVG] Key* in Chapter 4 for a discussion of trace smoothing and variable IF bandwidths.

BLOCK INPUT ERROR (error #34). The analyzer did not receive a complete data transmission. This is usually caused by an interruption of the bus transaction. Clear by pressing the **[LOCAL]** key or aborting the IO process at the controller.

BLOCK INPUT LENGTH ERROR (error #35). The length of the header received by the analyzer did not agree with the size of the internal array block. Refer to the *HP-IB Programming Guide* for instructions on using analyzer input commands.

CALIBRATION ABORTED (error #74). The calibration in progress was terminated due to change of the active channel.

CALIBRATION REQUIRED (error #63). A calibration set could not be found that matched the current stimulus state or measurement parameter. Refer to Chapter 5, *Measurement Calibration*. Calibration sets can be saved in internal or external memory. Refer to *[SAVE] Key* in Chapter 10.

CAN'T CHANGE-ANOTHER CONTROLLER ON BUS (error #37). The analyzer cannot assume the mode of system controller until the active controller is removed from the bus or relinquishes the bus.

CAN'T STORE/LOAD SEQUENCE, INSUFFICIENT MEMORY (error #127). A sequence transfer to or from an external disk could not be completed because of insufficient memory.

CH1 (CH2) TARGET VALUE NOT FOUND (error #159). The target value for the marker search function does not exist on the current data trace.

CONTINUOUS SWITCHING NOT ALLOWED (error #10). The current measurement requires the S-parameter test set to switch automatically between forward and reverse measurements (driving test port 1, then test port 2). To protect the transfer switch against undue mechanical wear, it will not switch continuously. The "tsH" (test set hold) indicator in the left margin of the display indicates that the inactive channel has been put in the sweep hold mode.

CORRECTION CONSTANTS NOT STORED (error #3). A store operation to the EEPROM was not successful. The position of the jumper on the A9 CPU assembly must be changed. Refer to *A9 CC Jumper Position Procedure* in the *Adjustments and Correction Constants* section of the service manual.

CORRECTION TURNED OFF (error #66). Critical parameters in the current instrument state do not match the parameters for the calibration set, therefore correction has been turned off. The critical instrument state parameters are sweep type, start frequency, frequency span, and number of points.

CURRENT PARAMETER NOT IN CAL SET (error #64). Correction is not valid for the selected measurement parameter. Refer to Chapter 5, *Measurement Calibration*.

D2/D1 INVALID WITH SINGLE CHANNEL (error #130). A D2/D1 measurement can only be made if both channels are on.

D2/D1 INVALID. CH1 CH2 NUM PTS DIFFERENT (error #152). A D2/D1 measurement can only be made if both channels have the same number of points.

DEADLOCK (error #111). A fatal firmware error occurred before instrument preset completed. Refer to *Troubleshooting* in the service manual.

DEMODULATION NOT VALID (error #17). Demodulation is only valid for the CW time mode. Refer to Chapter 8, *Time and Frequency Domain Transforms*.

DEVICE: not on, not connect, wrong addr (error #119). The device at the power meter address cannot be accessed by the analyzer. Verify power to the device, and check the HP-IB connection between the analyzer and the device. Ensure that the device address recognized by the analyzer matches the HP-IB address set on the device itself. Refer to *[LOCAL] Key* in Chapter 7 for instructions on setting peripheral addresses.

DISK HARDWARE PROBLEM (error #39). The disk drive is not responding correctly. Refer to the disk drive operating manual.

DISK IS WRITE PROTECTED (error #48). The store operation cannot write to a write-protected disk. Slide the write-protect tab over the write-protect opening in order to write data on the disk.

DISK MEDIUM NOT INITIALIZED (error #40). The disk must be initialized before it can be used. Refer to *Initialize Menu* in Chapter 10.

DISK: not on, not connected, wrong addr (error #38). The disk cannot be accessed by the analyzer. Verify power to the disk drive, and check the HP-IB connection between the analyzer and the disk drive. Ensure that the disk drive address recognized by the analyzer matches the HP-IB address set on the disk drive itself. Refer to *[LOCAL] Key* in Chapter 7 for instructions on setting peripheral addresses.

DISK WEAR – REPLACE DISK SOON (error #49). Cumulative use of the disk is approaching the maximum. Copy files as necessary using an external controller. If no controller is available, load instrument states from the old disk and store them to a newly initialized disk using the save/recall features of the analyzer. Refer to Chapter 10, *Saving Instrument States*, for information. Discard the old disk.

DUPLICATING TO THIS SEQUENCE NOT ALLOWED (error #125). A sequence cannot be duplicated to itself.

EXCEEDED 7 STANDARDS PER CLASS (error #72). A maximum of seven standards can be defined for any class. Refer to *Modifying Calibration Kits* in Chapter 5.

EXTERNAL SOURCE MODE REQUIRES CW TIME (error #148). An external source can only be phase locked and measured in the CW time sweep mode. Refer to Chapter 14 for information on the external source mode. Refer to *Sweep Type Menu* in Chapter 3 for information on CW time sweep.

FIRST CHARACTER MUST BE A LETTER (error #42). The first character of a disk file title or an internal save register title must be an alpha character.

FREQ OFFSET ONLY VALID IN NETWORK ANALYZER MODE (error #140). Frequency offset measurements can only be made in the network analyzer mode because this is the only mode that controls the source.

FUNCTION NOT VALID (error #14). The requested function is incompatible with the current instrument state.

FUNCTION NOT VALID DURING MOD SEQUENCE (error #131). Sequencing operations cannot be performed while a sequence is being modified.

ILLEGAL UNIT OR VOLUME NUMBER (error #46). The disk unit or volume number set in the analyzer is not valid. Refer to *HP-IB Menu* in Chapter 7 and to the disk drive operating manual.

INIT DISK removes all data from disk (information message, not an error). Continuing with the initialize operation will DESTROY any data currently on the disk.

INITIALIZATION FAILED (error #47). Disk initialization failed, probably because the disk is damaged.

INPUT OVERLOAD, ATTENUATOR SET TO MAX (error #160). This message occurs only with an HP 85047A test set when the instrument is in 6 GHz mode. The power level at the A or B input has exceeded the maximum allowed, and the attenuator has been set automatically to 70 dB to reduce the power. The annotation P↓ appears in the left margin of the display to indicate that power trip has been activated. Refer to *Power Menu* in Chapter 3. Toggle the **[POWER TRIP]** softkey off, and insert attenuation either with the internal attenuator or an external pad.

INSTRUMENT STATE MEMORY CLEARED (error #56). The five instrument state registers have been cleared from memory along with any saved calibration data or calibration kit definitions.

INSUFFICIENT MEMORY (error #51). The last front panel or HP-IB request could not be implemented due to insufficient memory space. In some cases, this is a fatal error which can only be escaped by presetting the instrument. See Chapter 10 for information on memory allocation.

INSUFFICIENT MEMORY, PWR MTR CAL OFF (error #154). A power meter calibration array requires more memory space than is currently available. Increase the available memory by clearing one or more save/recall registers, or by reducing the number of points.

INVALID KEY (error #2). An undefined softkey was pressed.

LIST TABLE EMPTY (error #9). The frequency list is empty. To implement list frequency mode, add segments to the list table. Refer to *Edit List Menu* in Chapter 3.

LOG SWEEP REQUIRES 2 OCTAVE MINIMUM SPAN (error #150). A logarithmic sweep is only valid if the stop frequency is greater than 4 times the start frequency. For frequency spans of less than two octaves, the sweep type automatically reverts to linear sweep.

LOW PASS: FREQ LIMITS CHANGED (information message, not an error). The frequency domain data points must be harmonically related from DC to the stop frequency. That is, $stop = n \times start$, where $n =$ number of points. If this condition is not true when a low pass mode (step or impulse) is selected and transform is turned on, the analyzer resets the start and stop frequencies. The stop frequency is set close to the entered stop frequency, and the start frequency is set equal to $stop/n$. Refer to *Time Domain Low Pass* in Chapter 8.

LOW PASS MODE NOT ALLOWED (error #18). Low pass time domain mode is allowed only with 801 points or less.

MEMORY FOR CURRENT SEQUENCE IS FULL (error #132). All the memory in the sequence being modified is filled with instrument commands.

MORE SLIDES NEEDED (error #71). When a sliding load is used (in a user-defined calibration kit), at least three slide positions are required to complete the calibration.

NO 6 GHZ TEST SET PRESENT (error #120). Sampler correction cannot be performed on an option 006 (6 GHz) instrument unless an HP 85047A 6 GHz test set is connected. Refer to *Sampler Magnitude and Phase Correction Constants* in the *Adjustments* section of the service manual.

NO CALIBRATION CURRENTLY IN PROGRESS (error #69). The **[RESUME CAL SEQUENCE]** softkey is not valid unless a calibration was already in progress. Start a new calibration. Refer to *Correction Menu* in Chapter 5.

NO DISK MEDIUM IN DRIVE (error #41). No disk was found in the current disk unit. Insert a disk, or check the disk unit number stored in the analyzer. Refer to *HP-IB Menu* in Chapter 7.

NO FAIL FOUND (service error #114). The self-diagnose function of the instrument operates on an internal test failure. At this time, no failure has been detected. Refer to *Internal Tests* in the *Service Key Menus* section of the *On-Site System Service Manual*.

NO FILE(S) FOUND ON DISK (error #45). No files of the type created by an analyzer store operation were found on the disk. Or if a specific file title was requested, that file was not found on the disk.

NO IF FOUND: CHECK R INPUT LEVEL (error #5). The first IF signal was not detected during pretune. Make sure the RF output is connected externally to the R input, with at least -35 dBm input power to R.

NO LIMIT LINES DISPLAYED (error #144). Limit lines are turned on but cannot be displayed on polar or Smith chart display formats.

NO MARKER DELTA — SPAN NOT SET (error #15). The *[MARKER → SPAN]* softkey function requires that delta marker mode be turned on, with at least two markers displayed. Refer to Chapter 6, *Using Markers*.

NO MEMORY AVAILABLE FOR INTERPOLATION (error #123). Interpolated error correction cannot be performed due to insufficient memory. Increase the available memory by clearing one or more save/recall registers.

NO MEMORY AVAILABLE FOR SEQUENCING (error #126). The sequence cannot be modified due to insufficient memory. Increase the available memory by clearing one or more save/recall registers.

NO PHASE LOCK: CHECK R INPUT LEVEL (error #7). The first IF signal was detected at pretune, but phase lock could not be acquired. Refer to *Troubleshooting* in the *On-Site System Service Manual*.

NO SPACE FOR NEW CAL. CLEAR REGISTERS (error #70). Insufficient memory is available to store a calibration set. Memory can be freed by clearing a saved instrument state, which will result in the deletion of a saved calibration set. The saved instrument state and calibration set can be stored to an external disk before being cleared from the internal register. Refer to Chapter 10 for information on the allocation of memory.

NO VALID MEMORY TRACE (error #54). If a memory trace is to be displayed or otherwise used, a data trace must first be stored to memory. Refer to *Display Menu* in Chapter 4.

NO VALID STATE IN REGISTER (error #55). A request to load an instrument state from an internal register was received over HP-IB, and that register is empty.

NOT ENOUGH SPACE ON DISK FOR STORE (error #44). The store operation will overflow the available disk space. Insert a new disk or purge the files appearing last in the directory, to create free disk space.

NOT VALID FOR PRESENT TEST SET (error #62). The calibration requested is inconsistent with the test set present. This message occurs in the following situations:

- A full 2-port calibration is requested with a test set other than an HP 85046A/B or 85047A S-parameter Test Set.
- A one-path 2-port calibration is requested with an S-parameter test set (this procedure is typically used with a transmission/reflection test set).

ONLY LETTERS AND NUMBERS ARE ALLOWED (error #43). Only alpha-numeric characters are allowed in disk file titles or internal save register titles. Other symbols are not allowed.

OPTIONAL FUNCTION; NOT INSTALLED (error #1). The function you requested requires a capability provided by an option to the standard analyzer. That option is not currently installed. (Options are 002 harmonic measurement capability, 006 6 GHz receiver operation, and 010 time domain transform.)

OVERLOAD ON INPUT A, POWER REDUCED (error #58)

OVERLOAD ON INPUT B, POWER REDUCED (error #59)

OVERLOAD ON INPUT R, POWER REDUCED (error #57). When the power level at one of the three receiver inputs exceeds approximately +4 dBm, the RF output power level is automatically reduced to -5 dBm. The annotation P↓ appears in the left margin of the display to indicate that the power trip function has been activated. When this occurs, toggle the *[POWER TRIP]* softkey off and reset the power at a lower level. Refer to *Power Menu* in Chapter 3. (In certain circumstances, power trip is indicated by error #160, INPUT OVERLOAD, ATTENUATOR SET TO MAX.)

PHASE LOCK CAL FAILED (error #4). An internal phase lock calibration routine is automatically executed at power-on and preset any time a loss of phase lock is detected. This message indicates that phase lock calibration was initiated and the first IF detected, but a problem prevented the calibration from completing successfully. Refer to the *Troubleshooting* section of the *On-Site System Service Manual*, and execute pretune correction test 48.

If a mixer is connected between the RF output and R input before frequency offset mode is turned on, this message may appear. Ignore it: it will go away when frequency offset is turned on. Or it may appear if frequency offset mode is entered before the offset is defined. Refer to Chapter 14 for information.

PHASE LOCK LOST (error #8). Phase lock was acquired but then lost. Refer to the *Troubleshooting* section of the service manual, and to *Service Modes Menu* in the *Service Key Menus* section.

PLOT ABORTED (error #27). Pressing the [LOCAL] key causes the analyzer to abort the plot in progress.

PLOTTER: not on, not connect, wrong addrs (error #26). The plotter does not respond to control. Verify power to the plotter, and check the HP-IB connection between the analyzer and the plotter. Ensure that the plotter address recognized by the analyzer matches the HP-IB address set on the plotter itself. Refer to [LOCAL] Key in Chapter 7 for instructions on setting peripheral addresses.

PLOTTER NOT READY-PINCH WHEELS UP (error #28). The plotter pinch wheels clamp the paper in place. When the pinch wheels are raised, the plotter indicates a "not ready" status on the bus.

POSSIBLE FALSE LOCK (error #6). Phase lock has been achieved, but the source may be phase locked to the wrong harmonic of the synthesizer. Perform the source pretune correction routine in the *Adjustments* section of the service manual.

POW MET INVALID (error #116). The power meter indicates an out-of-range condition. Check the test setup.

POW MET NOT SETTLED (error #118). Sequential power meter readings are not consistent. Verify that the equipment is set up correctly. If so, preset the instrument and restart the routine.

POW MET: not on, not connected, wrong addrs (error #117). The power meter cannot be accessed by the analyzer. Verify that the power meter address and model number set in the analyzer match the address and model number of the actual power meter. Refer to [LOCAL] Key in Chapter 7 for more information.

POWER SUPPLY HOT! (error #21). The temperature sensors on the A8 post-regulator assembly have detected an overtemperature condition. The power supplies regulated on the post-regulator have been shut down.

POWER SUPPLY SHUT DOWN! (error #22). One or more supplies on the A8 post-regulator assembly have been shut down due to an overcurrent, overvoltage, or undervoltage condition.

PRESENT LIST FREQ INVALID IN 3 GHZ RANGE (error #139). Frequency list segments above 3 GHz were set while the instrument was in 6 GHz mode using the HP 85047A test set. These frequencies can only be used in the 6 GHz mode. Either change the frequency list or press [FREQ RANGE 3GHz6GHz] to turn on the 6 GHz mode.

PRINT ABORTED (error #25). Pressing the [LOCAL] key causes the analyzer to abort output to the printer.

PRINTER: not on, not connected, wrong addr (error #24). The printer does not respond to control. Verify power to the printer, and check the HP-IB connection between the analyzer and the printer. Ensure that the printer address recognized by the analyzer matches the HP-IB address set on the printer itself. Refer to *[LOCAL] Key* in Chapter 7 for instructions on setting peripheral addresses.

PRINT/PLOT IN PROGRESS, ABORT WITH LOCAL (information message, not an error). If a print or plot is in progress and a second print or plot is attempted, this message is displayed and the second attempt is ignored. To abort a print or plot in progress, press **[LOCAL]**.

PROBE POWER SHUT DOWN! (error #23). The analyzer biasing supplies to the HP 85024A external probe are shut down due to excessive current. Troubleshoot the probe, and refer to the *Power Supply* troubleshooting section of the service manual.

REQUESTED DATA NOT CURRENTLY AVAILABLE (error #30). The analyzer does not currently contain the data being requested. For example, this condition occurs when error term arrays are requested and no calibration is active.

SAVE FAILED. INSUFFICIENT MEMORY (error #151). The instrument state could not be saved in an internal register because of insufficient memory. Increase the available memory by clearing one or more save/recall registers, or by storing files to an external disk. Refer to Chapter 10 for information.

SELECTED SEQUENCE IS EMPTY (error #124). The sequence you tried to run does not contain instrument commands.

SELF TEST #n FAILED (service error #112). Internal test #n has failed. Several internal test routines are executed at instrument preset. The analyzer reports the first failure detected. Refer to the *Troubleshooting* section of the *On-Site System Service Manual* for more information on internal tests and the self-diagnose feature.

SEQUENCE ABORTED (error #157). The running sequence was stopped prematurely when the operator pressed the **[LOCAL]** key.

SEQUENCE MAY HAVE CHANGED, CAN'T CONTINUE (error #153). The sequence that was paused cannot be continued because it has been modified. The sequence must be started again.

SLIDES ABORTED (MEMORY REALLOCATION) (error #73). Insufficient memory is available for sliding load measurements. Reduce memory usage by clearing save/recall registers (see Chapter 10, *Saving Instrument States*), then repeat the sliding load measurements.

SOURCE PARAMETERS CHANGED (error #61). Some of the stimulus parameters of the instrument state have been changed, due to a request to turn correction on. A calibration set for the current measurement parameter was found and activated. The instrument state was updated to match the stimulus parameters of the calibration state.

This message also appears when harmonic mode or frequency offset is turned on and the present frequency range cannot be used with one of these modes.

SOURCE POWER TRIPPED, RESET UNDER POWER MENU (information message, not an error). The power level at one of the inputs has exceeded the maximum allowed, and power has been automatically reduced. The annotation P↓ indicates that power trip has been activated. Press **[MENU] [POWER] [POWER TRIP ON]** to turn off the power trip, then reset the power at a lower level. This message follows error #57-59, OVERLOAD ON INPUT A (B, R), POWER REDUCED and error #160, INPUT OVERLOAD, ATTENUATOR SET TO MAX, and repeats every sweep until the power trip is cleared.

SWEEP TIME INCREASED (error #11). Sweep time is automatically increased to compensate for other instrument state changes. Some parameter changes that cause an increase in sweep time are narrower IF bandwidth, an increase in the number of points, and a change in sweep type.

SWEEP TIME TOO FAST (error #12). The fractional-N and digital IF circuits have lost synchronization. Refer to the *Troubleshooting* section in the *On-Site System Service Manual*.

SWEEP TRIGGER SET TO HOLD (information message, not an error). The instrument is in a hold state and is no longer sweeping.

SWEEP TYPE CHANGED TO LINEAR SWEEP (error #145). If the frequency list mode is active when the **[FREQ RANGE 3GHz6GHz]** softkey is pressed, or when the instrument mode is changed to harmonic measurements, and the list frequencies do not fall in the allowable frequency range of these modes, the list mode is turned off.

SYNTAX ERROR (error #33). An improperly formatted command was received over HP-IB. Refer to the *HP-IB Quick Reference Guide* for proper command syntax.

SYST CTRL OR PASS CTRL IN LOCAL MENU (error #36). The analyzer cannot control a peripheral device on the bus while it is in talker/listener mode. Use the local menu to change to system controller or pass control mode. Refer to **[LOCAL]** Key in Chapter 7 for information on HP-IB controller modes.

SYSTEM IS NOT IN REMOTE (error #52). The analyzer is in local mode. In this mode, the analyzer will not respond to HP-IB commands with front panel key equivalents. It will, however, respond to commands that have no such equivalents, such as status requests.

TEST ABORTED (error #113). A service test has been prematurely stopped at the operator's request.

THIS LIST FREQ INVALID IN HARM/3 GHZ RNG (error #133). The frequencies in the list do not fall in the allowable frequency range for harmonic measurements, or for 6 GHz operation with an HP 85047A test set. Reduce the frequency range of the list.

TOO MANY SEGMENTS OR POINTS (error #50). Frequency list mode is limited to 30 segments or 1632 points. Refer to *Edit List Menu* in Chapter 3 for more information.

In power meter calibration, the power sensor cal factor and power loss functions are limited to 12 segments. Refer to *Power Meter Calibration* in Chapter 5.

TRANSFORM, GATE NOT ALLOWED (error #16). Transformation to the time domain is only possible in linear and CW sweep types.

TROUBLE! CHECK SETUP AND START OVER (service error #115). The equipment setup for the adjustment procedure in progress is not correct. Check the setup diagram and instructions in the *Adjustments and Correction Constants* section of the *On-Site System Service Manual*. Start the procedure again.

WAITING FOR CLEAN SWEEP (information message, not an error). In single sweep mode, the instrument ensures that all changes to the instrument state, if any, have been implemented before taking the sweep. The command that the instrument is currently processing will not complete until the new sweep completes. An asterisk * is displayed in the left margin of the CRT until a complete fresh sweep has been taken.

WAITING FOR DISK (information message, not an error). This message is displayed between the start and finish of a read or write operation to a disk.

WAITING FOR HP-IB CONTROL (information message, not an error). The analyzer has been instructed to use pass control (USEPASC). When the instrument next receives an instruction requiring active controller mode, it requests control of the bus and simultaneously displays this message. If the message remains, the system controller is not relinquishing the bus.

WRITE ATTEMPTED WITHOUT SELECTING INPUT TYPE (error #32). The data header "#A" for the analyzer was received with no preceding input command (such as INPUDATA). The instrument recognized the header but did not know what type of data to receive. Refer to the *HP-IB Quick Reference Guide* for command syntax information.

WRONG DISK FORMAT, INITIALIZE DISK (error #77). A command to store, load, or read file titles has been received, but the disk format does not conform to the Logical Interchange Format (LIF). The instrument must initialize the disk before reading or writing to it. Refer to *Initialize Menu* in Chapter 10.

3GHZ MAX FREQ. USE FREQ RANGE KEY (UNDER SYSTEM) (information message, not an error). Frequencies above 3 GHz can only be set when the instrument has been set to 6 GHz mode. Press [SYSTEM] [FREQ RANGE 3GHZ] so that it changes to [FREQ RANGE 6GHZ]. This message occurs only with an option 006 instrument used with an HP 85047A test set.

ERROR MESSAGES IN NUMERICAL ORDER

Refer to the alphabetical listing for explanations and suggestions for solving the problems.

1. OPTIONAL FUNCTION; NOT INSTALLED
2. INVALID KEY
3. CORRECTION CONSTANTS NOT STORED
4. PHASE LOCK CAL FAILED
5. NO IF FOUND: CHECK R INPUT LEVEL
6. POSSIBLE FALSE LOCK
7. NO PHASE LOCK: CHECK R INPUT LEVEL
8. PHASE LOCK LOST
9. LIST TABLE EMPTY
10. CONTINUOUS SWITCHING NOT ALLOWED
11. SWEEP TIME INCREASED
12. SWEEP TIME TOO FAST
13. AVERAGING INVALID ON NON-RATIO MEASURE
14. FUNCTION NOT VALID
15. NO MARKER DELTA – SPAN NOT SET
16. TRANSFORM, GATE NOT ALLOWED
17. DEMODULATION NOT VALID
18. LOW PASS MODE NOT ALLOWED
21. POWER SUPPLY HOT!
22. POWER SUPPLY SHUT DOWN!
23. PROBE POWER SHUT DOWN!
24. PRINTER: not on, not connect, wrong addr
25. PRINT ABORTED
26. PLOTTER: not on, not connect, wrong addr
27. PLOT ABORTED
28. PLOTTER NOT READY-PINCH WHEELS UP
30. REQUESTED DATA NOT CURRENTLY AVAILABLE
31. ADDRESSED TO TALK WITH NOTHING TO SAY
32. WRITE ATTEMPTED WITHOUT SELECTING INPUT TYPE
33. SYNTAX ERROR
34. BLOCK INPUT ERROR
35. BLOCK INPUT LENGTH ERROR
36. SYST CTRL OR PASS CTRL IN LOCAL MENU
37. CAN'T CHANGE-ANOTHER CONTROLLER ON BUS
38. DISK: not on, not connected, wrong addr
39. DISK HARDWARE PROBLEM
40. DISK MEDIUM NOT INITIALIZED
41. NO DISK MEDIUM IN DRIVE
42. FIRST CHARACTER MUST BE A LETTER
43. ONLY LETTERS AND NUMBERS ARE ALLOWED
44. NOT ENOUGH SPACE ON DISK FOR STORE
45. NO FILE(S) FOUND ON DISK
46. ILLEGAL UNIT OR VOLUME NUMBER
47. INITIALIZATION FAILED
48. DISK IS WRITE PROTECTED
49. DISK WEAR-REPLACE DISK SOON
50. TOO MANY SEGMENTS OR POINTS
51. INSUFFICIENT MEMORY
52. SYSTEM IS NOT IN REMOTE
54. NO VALID MEMORY TRACE

- | | |
|---|--|
| 55. NO VALID STATE IN REGISTER | 120. NO 6 GHZ TEST SET PRESENT |
| 56. INSTRUMENT STATE MEMORY CLEARED | 123. NO MEMORY AVAILABLE FOR INTERPOLATION |
| 57. OVERLOAD ON INPUT R, POWER REDUCED | 124. SELECTED SEQUENCE IS EMPTY |
| 58. OVERLOAD ON INPUT A, POWER REDUCED | 125. DUPLICATING TO THIS SEQUENCE NOT ALLOWED |
| 59. OVERLOAD ON INPUT B, POWER REDUCED | 126. NO MEMORY AVAILABLE FOR SEQUENCING |
| 61. SOURCE PARAMETERS CHANGED | 127. CAN'T STORE/LOAD SEQUENCE, INSUFFICIENT MEMORY |
| 62. NOT VALID FOR PRESENT TEST SET | 130. D2/D1 INVALID WITH SINGLE CHANNEL |
| 63. CALIBRATION REQUIRED | 131. FUNCTION NOT VALID DURING MOD SEQUENCE |
| 64. CURRENT PARAMETER NOT IN CAL SET | 132. MEMORY FOR CURRENT SEQUENCE IS FULL |
| 66. CORRECTION TURNED OFF | 133. THIS LIST FREQ INVALID IN HARM/3 GHZ RNG |
| 68. ADDITIONAL STANDARDS NEEDED | 139. PRESENT LIST FREQ INVALID IN 3 GHZ RANGE |
| 69. NO CALIBRATION CURRENTLY IN PROGRESS | 140. FREQ OFFSET ONLY VALID IN NETWORK ANALYZER MODE |
| 70. NO SPACE FOR NEW CAL. CLEAR REGISTERS | 144. NO LIMIT LINES DISPLAYED |
| 71. MORE SLIDES NEEDED | 145. SWEEP TYPE CHANGED TO LINEAR SWEEP |
| 72. EXCEEDED 7 STANDARDS PER CLASS | 148. EXTERNAL SOURCE MODE REQUIRES CW TIME |
| 73. SLIDES ABORTED (MEMORY REALLOCATION) | 150. LOG SWEEP REQUIRES 2 OCTAVE MINIMUM SPAN |
| 74. CALIBRATION ABORTED | 151. SAVE FAILED. INSUFFICIENT MEMORY |
| 77. WRONG DISK FORMAT, INITIALIZE DISK | 152. D2/D1 INVALID. CH1 CH2 NUM PTS DIFFERENT |
| 111. DEADLOCK. | 153. SEQUENCE MAY HAVE CHANGED, CAN'T CONTINUE |
| 112. SELF TEST #n FAILED | 154. INSUFFICIENT MEMORY, PWR MTR CAL OFF |
| 113. TEST ABORTED | 157. SEQUENCE ABORTED |
| 114. NO FAIL FOUND | 159. CH1 (CH2) TARGET VALUE NOT FOUND |
| 115. TROUBLE! CHECK SETUP AND START OVER | 160. INPUT OVERLOAD, ATTENUATOR SET TO MAX |
| 116. POW MET INVALID | |
| 117. POW MET: not on, not connected, wrong addr | |
| 118. POW MET NOT SETTLED | |
| 119. DEVICE: not on, not connect, wrong addr | |

Chapter 13. Test Sequence Function

CHAPTER CONTENTS

13-1	What is Test Sequencing?	13-11	Store Sequence to Disk Menu
13-2	Creating a Sequence	13-12	Load Sequence from Disk Menu
13-2	Running a Sequence	13-13	Purge Sequence from Disk Menu
13-2	Stopping a Sequence	13-14	Sequence More Menu
13-3	Changing the Sequence Title	13-15	Sequencing Special Functions
13-3	Editing a Sequence	13-15	Important Concepts
13-4	Clearing a Sequence from Memory	13-16	Autostarting Sequences
13-4	Storing a Sequence to Disk	13-16	Sequencing Special Function Menu
13-5	Loading a Sequence from Disk	13-17	Sequencing Decision Making Menu
13-6	Purging a Sequence from Disk	13-19	Sequencing Special Function More Menu
13-6	Printing a Sequence	13-20	HP-GL Considerations
13-6	In-Depth Sequencing Information	13-21	Entering Sequences Using HP-IB
13-8	Basic Sequencing Menus	13-21	Reading Sequences Using HP-IB
13-9	Do Sequence Menu	13-21	Decision-Making Example Sequences
13-10	New Sequence/Modify Sequence Menu		

WHAT IS TEST SEQUENCING?

Test sequencing automates repetitive tasks. In sequencing mode you make the measurement once and the analyzer memorizes the keystrokes. Later the entire sequence can be repeated by pressing a single key. Because the sequence is defined with normal measurement keystrokes, no additional programming expertise is required. Limited decision-making increases the flexibility of test sequences.

The test sequence function allows the user to create, title, save, and execute up to six independent sequences internally. Test sequences can dramatically reduce the time required to make a multiple step measurement, and can greatly reduce operator errors.

Sequences may be saved to external disk and can be transferred between the analyzer and an external computer controller.

The following procedures are based on an actual measurement example, and show you how to create, title, edit, clear, and (optionally) store, load, or purge a sequence. Performing these sample procedures will teach you how to use basic test sequencing in a very short amount of time.

Product note 8753-3 *RF Component Measurements - Applications of the Test Sequence Function* also provides practical applications examples for test sequencing. This note was written for the HP 8753B but also applies to the HP 8753C.

CREATING A SEQUENCE

1. Press **[SYSTEM] [SEQUENCING MENU] [NEW SEQ/MODIFY SEQ]**.
2. The analyzer will display the six available sequences. Press **[SEQUENCE 1 SEQ1]** to select sequence number one. ("SEQ1" is the default title of that sequence.)
3. The following list will appear on the screen with an arrow cursor.

```
-> Start of Sequence
    1996 empty bytes available
```

4. Press the appropriate keys for the desired measurement. Note that the **[RECALL PRST STATE]** (recall preset state) softkey is available under the **[RECALL]** key. This command is the only way to preset the instrument in a sequence. It is recommended that sequences begin with this command.

Example Sequence:

Connect a test cable between the RF output and R input. Enter the following commands on the analyzer:

```
[RECALL] [RECALL PRST STATE]
[MEAS] [R]
[SCALE REF] [SCALE/DIV] [1] [x1]
[START] [1] [G/n]
[AVG] [SMOOTHING APERTURE] [5] [x1]
[SMOOTHING ON]
[DISPLAY] [DUAL CHAN ON]
[CH 2] [FORMAT] [SMITH CHART]
```

As you enter front panel commands, the list on the screen will show each entry. The available number of bytes for that sequence is displayed at the bottom of the list. If you make a mistake, refer to *Editing a Sequence*.

5. Press **[SYSTEM] [SEQUENCING MENU] [DONE MODIFY]**. The sequence is now ready to run.

NOTE: A sequence created in sequence position 6 is stored in nonvolatile memory and will survive if line power is turned off.

RUNNING A SEQUENCE

To run the sequence right after creating it, press the **[DO SEQUENCE]** softkey. While a sequence is running the analyzer's remote light is on, indicating that the analyzer can not be operated manually.

If **[PRESET]** is pressed, all sequences currently in memory are immediately presented in the softkey menu. To run a sequence, press the appropriate softkey.

1. Press **[PRESET]** now, followed by **[SEQUENCE 1 SEQ1]**. Notice the display changes (split display and Smith chart) caused by the sequence.

STOPPING A SEQUENCE

To stop a sequence before it has finished, press **[LOCAL]**.

CHANGING THE SEQUENCE TITLE

If sequences are to be stored to disk, it is recommended that they be given titles other than the default (SEQ1, SEQ2...). Titles entered from the front panel can be no longer than eight characters, must begin with a letter, and can contain only letters and numbers.

1. Press **[SYSTEM] [SEQUENCING MENU] [MORE] [TITLE SEQUENCE] [TITLE SEQ1]**. The screen now provides the available title characters. The current title is displayed in the upper left-hand corner of the screen.
2. Press the **[ERASE TITLE]** softkey. Move the knob until the arrow cursor is under the "A," and press **[SELECT LETTER]**. Continue until the title "ALPHA" has been entered, then press **[DONE] [PRESET]**. **[SEQUENCE ALPHA]** is now displayed as a softkey label.

EDITING A SEQUENCE

The sample measurement entered earlier will be used to demonstrate sequence editing.

1. Press **[PRESET] [SYSTEM] [SEQUENCING MENU] [NEW SEQ/MODIFY SEQ]**.
2. Press **[SEQUENCE 1 ALPHA]** to edit the sequence created earlier. The following is the list of commands entered in *Creating a Sequence*. Note that only part of the list can be shown on the screen at one time.

```
➔ Start of Sequence
  RECALL PRST STATE
  R
  SCALE/DIV
  SCALE/DIV
  1 x1
  START
  1 G/n
  SMOOTHING APERTURE
  5 x1
  SMOOTHING
  ON
  DUAL CHAN
```

The following lines are off screen:

```
  ON
  CH 2
  SMITH CHART
  1944 empty bytes available
```

The Active Line

The active line is always the line next to the => cursor.

Scrolling the Sequence Command List

The position of the cursor is fixed, and the command list moves up or down when the operator uses the rotary knob or the **[▲]** and **[▼]** keys. If you press the **[▲]** key, the list moves up, and the cursor points to the next command line.

3. Press the [**▲**] key until you reach the bottom of the list. Notice that the commands in the list are actually performed when the cursor points to them. This feature allows the sequence to be tested one command at a time. If you scroll past the end of the list, it will wrap-around back to the beginning. If the list is scrolled by pressing [**▼**] key the commands will not execute.

Editing Features

Three editing features are available in sequencing:

- Insert a command.
- Delete a command.
- Backspace (before the entry is terminated).

Inserting lines. Inserting requires no special keystrokes. Just type in the command to be inserted, and it will appear below the active line.

Deleting lines. Pressing the [**BACK SP**] (backspace) key deletes the entry next to the cursor.

To replace a command, delete the original and insert a new command in its place.

Backspacing Before the Entry is Terminated. When entering a command such as start frequency, you can backspace over an incorrect number before the units terminator key is pressed. For example, if [**START**][**1**][**2**] is pressed, followed by the backspace key, the 2 is deleted. However, if a terminator key is pressed (such as G/n), backspacing deletes the whole command.

4. Press the [**▼**] key until the cursor points to the line shown:

```
SCALE/DIV
=> 1 x1
START
1 G/n
```

5. Press [**BACK SP**]. The line will disappear.
6. Press [**2**] [**x1**]. The sequence, when run, will now choose a scale factor of 2 dB/div.
7. Press [**SYSTEM**] [**SEQUENCING MENU**] [**DONE MODIFY**] to exit the modify (edit) mode.

CLEARING A SEQUENCE FROM MEMORY

This procedure is given for reference only. Do not clear the sequence "ALPHA" created in previous steps, as it is used in later examples.

1. Press [**SYSTEM**] [**SEQUENCING MENU**] [**MORE**] [**CLEAR SEQUENCE**]. Press the softkey of the sequence to be cleared.

STORING A SEQUENCE TO DISK

Set Up the Disk Drive and Set the Analyzer to System Controller Mode

1. Connect an HP 9122 (or other CS-80 compatible disk drive) to the analyzer. The disk drive must be HP-IB compatible. Make sure the analyzer is programmed with the disk drive's HP-IB address using the [**LOCAL**] [**SET ADDRESSES**] [**ADDRESS: DISK**] keys.
2. Disconnect the analyzer from any computer controller. Set the instrument to system controller mode by pressing [**LOCAL**] [**SYSTEM CONTROLLER**].

Format a Blank Disk

3. If necessary, format a blank disk by inserting it into drive 0 and pressing **[SAVE] [STORE TO DISK] [DEFINE STORE] [MORE] [INITIALIZE DISK] [INIT DISK? YES]**.

Save Sequence to Disk

4. Press **[SYSTEM] [SEQUENCING MENU] [STORE SEQ TO DISK]**. The sequences currently in memory will be displayed in the softkey labels.
5. Select the desired sequence to store. To store the sequence created in the above example, press **[STORE SEQ ALPHA]**. If "CAUTION: SYST CTRL OR PASS CTRL in LOCAL menu" appears on the screen, the analyzer is not in system controller mode. Perform step 2 before saving a sequence to disk.



The save sequence to disk function will overwrite a file on the disk that has the same title. There is no warning to the user when a file is to be overwritten.

6. The disk drive access light should turn on briefly. When it goes out, the sequence has been saved.

LOADING A SEQUENCE FROM DISK

This procedure assumes the disk drive and analyzer have been set up as described in *Storing a Sequence to Disk*, and that a sequence titled "ALPHA" has been saved. Sequences are saved to disk independently of instrument state information.

There are two methods of loading a sequence:

- **If the sequence title is known.** Use the title menu to rename one of the six sequence softkeys with the name of the desired sequence. The procedure is described below.
- **If the sequence title is not known,** the contents of the disk can be viewed (six titles at a time). When the desired title appears on the display it can be loaded. Files are stored on disk in chronological order. The procedure is described below.

Loading a Sequence When the Title Is Known

1. Press **[SYSTEM] [SEQUENCING MENU] [LOAD SEQ FROM DISK]**. If the desired sequence name is not on the load sequence from disk menu, perform step 2.
2. Change one of the six sequence titles to match that of the desired sequence by pressing **[SYSTEM] [SEQUENCING MENU] [MORE] [TITLE SEQUENCE]** followed by one of the six sequence softkeys. Press **[ERASE TITLE]** if necessary and change the title as explained in *Creating a Sequence*. Press **[DONE] [RETURN] [LOAD SEQ FROM DISK]**.
3. Press the softkey next to the title of the desired sequence. The disk access light should come on briefly. When it goes out the sequence is loaded.

Loading a Sequence When the Title Is Not Known

This procedure assumes the desired file exists on the disk in drive 0.

1. Press **[SYSTEM] [SEQUENCING MENU] [LOAD SEQ FROM DISK] [READ SEQ FILE TTLS]**. The titles of the first six sequences on the disk will appear. If the desired sequence is not among the first six files, keep pressing **[READ SEQ FILE TTLS]** until the desired file name appears. Files are stored in chronological order.
2. Press the softkey next to the title of the desired sequence. The disk access light should come on briefly. When it goes out the sequence is loaded.

PURGING A SEQUENCE FROM DISK

1. Press **[SYSTEM] [SEQUENCING MENU] [STORE SEQ TO DISK] [PURGE SEQUENCES]**. The name of the desired sequence must show on the menu before it can be purged. As with loading a file, the title in one of the sequence softkey labels can be changed to the desired filename, or the disk can be searched. Refer to *Loading a Sequence From Disk* for details.
2. Once the proper sequence name is in one of the purge sequence softkey labels, press the softkey. The disk access light will turn on briefly. When it goes out the file is purged. Once purged, a file cannot be retrieved.

PRINTING A SEQUENCE

Set Up the Printer and Set the Analyzer to System Controller Mode

1. Connect a compatible printer to the analyzer (refer to *Plotters and Printers* in the *Other Accessories Available* portion of *General Information and Specifications*). Make sure the analyzer is programmed with the printer's HP-IB address using the **[LOCAL] [SET ADDRESSES] [ADDRESS: PRINTER]** keys.
2. Disconnect the analyzer from any external computer controller. Set the instrument to system controller mode by pressing **[LOCAL] [SYSTEM CONTROLLER]**.
3. The sequence to be printed must be in analyzer memory. When the printer is ready to print, press **[SYSTEM] [SEQUENCING MENU] [MORE] [PRINT SEQUENCE]**. Press the softkey for the desired sequence.

IN-DEPTH SEQUENCING INFORMATION

The following information explains details of the basic sequencing operation.

Features That Operate Differently When Executed in a Sequence

The knob, step keys, **[PRESET]** key, and **[BACK SP]** softkey cannot be used in a sequence.

Commands That Sequencing Completes Before the Next Sequence Command Begins. Sequencing completes all operations related to the following commands before continuing.

- Single sweep.
- Number of groups.
- Auto scale.
- Marker search.
- Marker function.
- Data → memory.
- Recall or save (internal or external).
- Copy list values and operating parameters.
- CH1, CH2, Wait 0*.

*Wait 0 is the special sequencing function *[WAIT x]* with a zero entered for the delay value.

Commands That Require a Clean Sweep. Many front panel commands disrupt the sweep in progress. Changing the channel or measurement type are examples. When a disruptive command is executed in a sequence, it inhibits some instrument functions until a complete sweep is taken. This applies to the following functions:

- Autoscale.
- Data → memory.

Forward Stepping in Edit Mode

Forward stepping through the sequence list executes each step. Decision making calls to other sequences do not occur, however. Instead, the cursor jumps to the end of the sequence.

Titles

A title may contain non-printable or special ASCII characters if it is downloaded from an external controller. A non-printable character is represented on the display as π .

Sequence Size

A sequence may contain up to 2 kbytes of instructions. Typically, this is around 200 sequence command lines. To estimate a sequence's size (in kBytes), use the following guidelines.

Type of Command	Size in Bytes
Typical command	2
Title string character	1
Active entry command	1 per digit

Embedding the Value of the Loop Counter in a Title

The title of stored data can have a sequentially increasing or decreasing numeric value appended to it by placing a *[DISPLAY] [MORE] [TITLE] [MORE] [LOOP COUNTER]* command after the title string. (The title itself must be limited to three characters if it is to be used as a disk file name. The three-character title and five-digit loop counter number reach the eight-character limit for disk file names.) This feature is useful in data logging applications. The loop counter example given later in this chapter shows how to perform this operation.

BASIC SEQUENCING MENUS

Figure 13-1 shows all basic sequencing menus. Special functions and their menus are described later in this chapter.

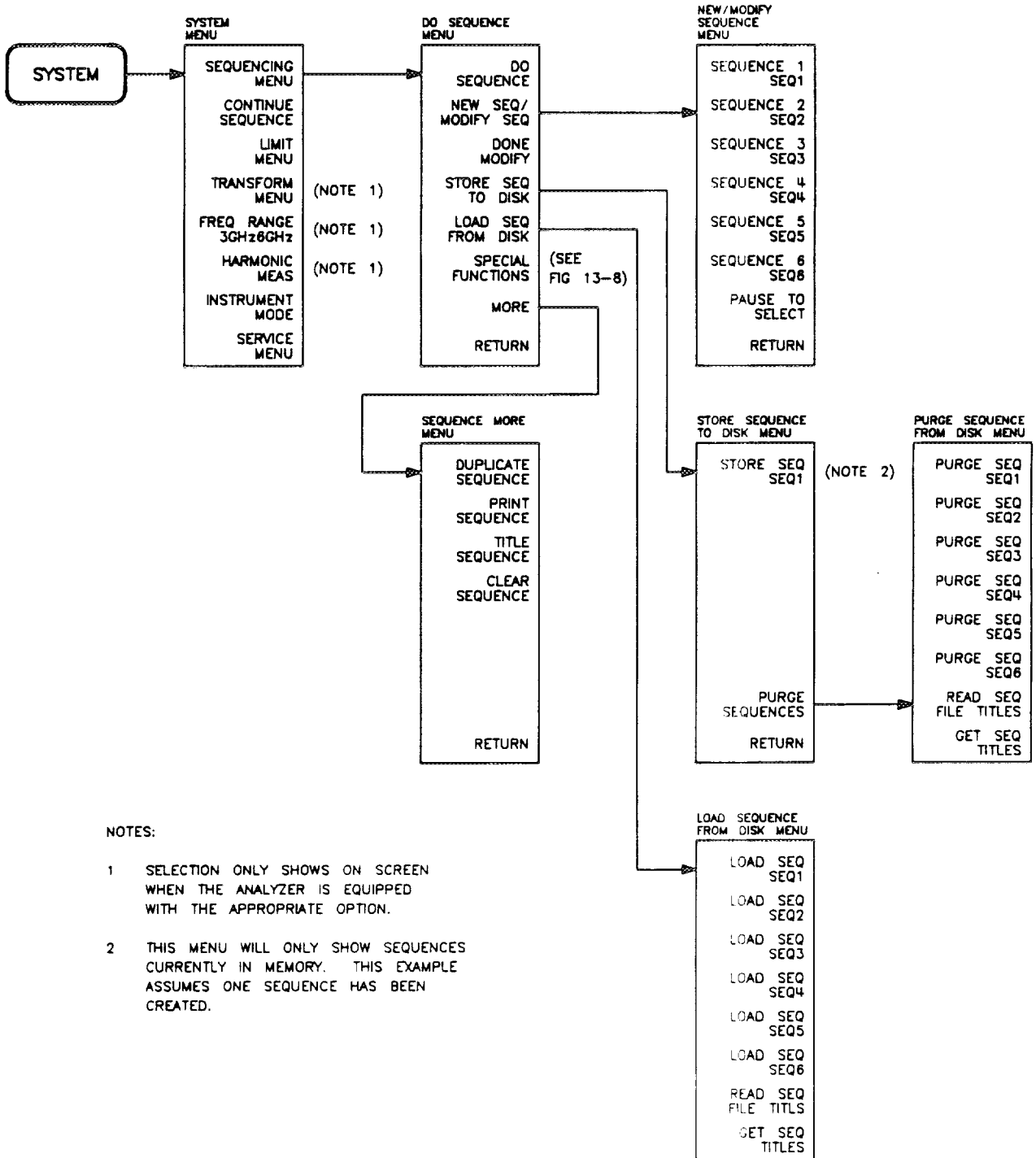

NOTES:

- 1 SELECTION ONLY SHOWS ON SCREEN WHEN THE ANALYZER IS EQUIPPED WITH THE APPROPRIATE OPTION.
- 2 THIS MENU WILL ONLY SHOW SEQUENCES CURRENTLY IN MEMORY. THIS EXAMPLE ASSUMES ONE SEQUENCE HAS BEEN CREATED.

Figure 13-1. Basic Sequencing Menus

Do Sequence Menu

Figure 13-2 shows the commands available in the do sequence menu.

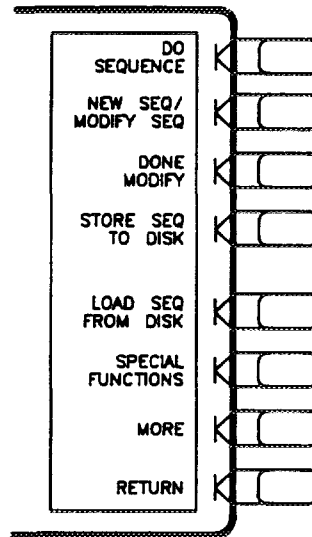

Figure 13-2. Do Sequence Menu

[DO SEQUENCE] (DOSEQn) has two functions:

- It shows the current sequences in memory. To run a sequence, press the softkey next to the desired sequence title.
- When entered into a sequence, this command performs a one-way jump to the sequence residing in the specified sequence position (SEQUENCE 1 through 6). **[DO SEQUENCE]** jumps to a softkey position, not to a specific sequence title. Whatever sequence is in the selected softkey position will run when the **[DO SEQUENCE]** command is executed. This command prompts the operator to select a destination sequence position.

[NEW SEQ/MODIFY SEQ] (NEWSEQn) activates the edit mode and presents the new/modify sequence menu with a list of sequences that can be created or modified.

[DONE MODIFY] (DONM) terminates the edit mode.

[STORE SEQ TO DISK] (STORSEQn) presents the store sequence to disk menu with a list of sequences that can be stored.

[LOAD SEQ FROM DISK] (LOADSEQn) presents the load sequence from disk menu. Select the desired sequence and the analyzer will load it from disk.

[SPECIAL FUNCTIONS] presents the special function menu. Available selections include:

- Jump to a sequence (**[DO SEQUENCE]**).
- Limit test decision (**[IF LIMIT TEST PASS]** **[IF LIMIT TEST FAIL]**).
- Loop counter value manipulation (increment/decrement, set value).
- Loop counter decision (**[IF COUNTER = 0]**, **[IF COUNTER <> 0]**).

- Send command to printer ([TITLE TO PRINTER]).
- Send command to HP-IB device ([TITLE TO P MTR/HPIB]).
- Wait.
- Pause.
- Set CW stimulus frequency to frequency of active marker ([MARKER → CW]).
- Emit beep.
- Assert SRQ.
- Output TTL high or TTL low.
- Show menu to operator/show menu in sequence listing ([SHOW MENUS]).
- Read data from HP-IB device ([P MTR/HPIB TO TITLE] followed by [TITLE TO MEMORY]).
- Move data to data array memory ([TITLE TO MEMORY]).

[MORE] presents the sequence more menu.

[RETURN] returns to the system menu.

New/Modify Sequence Menu

Procedures for creating and editing sequences are provided at the beginning of this chapter. Figure 13-3 shows the commands available in this menu: Use this to select the sequence to be created or modified. Sequences in positions 1 through 5 are stored in volatile memory and are erased if line power is turned off. Sequence position 6 is stored in non-volatile memory and will survive if line power is turned off.

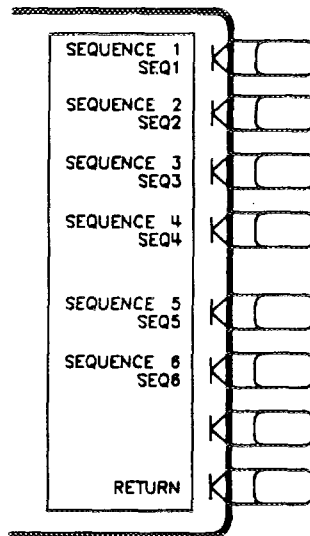

Figure 13-3. New/Modify Sequence Menu

[SEQUENCE 1 SEQ1] (NEWSEQ1) activates editing mode for the segment titled "SEQ1" (default title).

[SEQUENCE 2 SEQ2] (NEWSEQ2) activates editing mode for the segment titled "SEQ2" (default title).

[SEQUENCE 3 SEQ3] (NEWSEQ3) activates editing mode for the segment titled "SEQ3" (default title).

[SEQUENCE 4 SEQ4] (NEWSEQ4) activates editing mode for the segment titled "SEQ4" (default title).

[SEQUENCE 5 SEQ5] (NEWSEQ5) activates editing mode for the segment titled "SEQ5" (default title).

[SEQUENCE 6 SEQ6] (NEWSEQ6) activates editing mode for the segment titled "SEQ6" (default title).

[PAUSE TO SELECT] (PTOS) when put in a sequence, presents the menu of up to 6 available sequences (softkeys containing non-empty sequences). The message "CHOOSE ONE OF THESE SEQUENCES" is displayed and the present sequence stopped. If the operator selects one of the sequences, that sequence is executed. Any other key can be used to exit this mode. This function is not executed if used during modify mode and does nothing when operated manually.

[RETURN] returns to the do sequence menu

Store Sequence to Disk Menu

A procedure for storing a sequence to disk is provided at the beginning of this chapter. Figure 13-4 shows the commands available in this menu. Select the desired sequence and the analyzer will store it to a compatible disk drive.

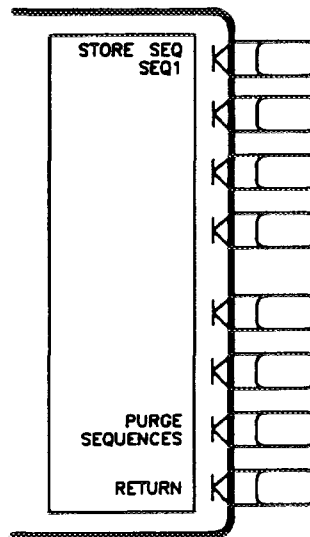

Figure 13-4. Store Sequence to Disk menu

The store sequence to disk menu shows only the titles of sequences currently in memory. Figure 13-4 is an example menu showing a single sequence in memory. Storing to disk requires a CS-80 compatible HP-IB disk drive such as the HP 9122. The analyzer must have the address of the disk drive and be in system controller mode.

[STORE SEQ SEQ1] (STORSEQ1) the sequence "SEQ1" is in memory. Pressing this softkey will store "SEQ1" to the disk.

[PURGE SEQUENCES] presents the purge sequence from disk menu.

[RETURN] returns to the do sequence menu.

Load Sequence from Disk Menu

Loading a sequence from disk is explained at the beginning of this chapter. Use this menu to select the desired sequence and the analyzer will load it from disk.

This menu shows default sequence names unless:

1. The operator has changed one or more of the titles, or...
2. A sequence with a different title has been loaded.

In these cases, the softkey labels will show any 8-character title the operator has entered.

Figure 13-5 shows the load sequence from disk menu.

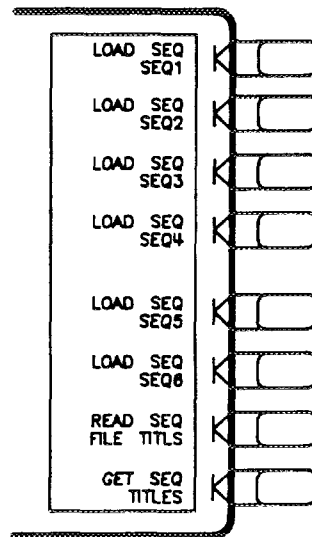

Figure 13-5. Load Sequence from Disk Menu

[LOAD SEQ SEQ1] (LOADSEQ1) loads SEQ1 from disk to internal memory.

[LOAD SEQ SEQ2] (LOADSEQ2) loads SEQ2 from disk to internal memory.

[LOAD SEQ SEQ3] (LOADSEQ3) loads SEQ3 from disk to internal memory.

[LOAD SEQ SEQ4] (LOADSEQ4) loads SEQ4 from disk to internal memory.

[LOAD SEQ SEQ5] (LOADSEQ5) loads SEQ5 from disk to internal memory.

[LOAD SEQ SEQ6] (LOADSEQ6) loads SEQ6 from disk to internal memory.

[READ SEQ FILE TITLS] is a disk file directory command. Pressing this softkey will read the first six sequence titles and display them in the softkey labels as described in *Loading a Sequence When the Title Is Not Known*. These sequences can then be loaded into internal memory.

If **[READ SEQ FILE TITLS]** is pressed again, the next six sequence titles on the disk will be displayed. To read the contents of the disk starting again with the first sequence: remove the disk, reinsert it into the drive, and press **[READ SEQ FILE TITLS]**.

[GET SEQ TITLES] copies the sequence titles currently in memory into the six softkey positions.

Purge Sequence from Disk Menu

A procedure for purging a sequence from disk is provided at the beginning of this chapter. Use this menu to select the sequence to be purged from disk. This menu shows default sequence names unless:

1. The operator has changed one or more of the titles, or...
2. A sequence with a different title has been loaded.

In these cases, the softkey labels will show any 8-character title the operator has entered.

Figure 13-6 shows the purge sequence from disk menu.

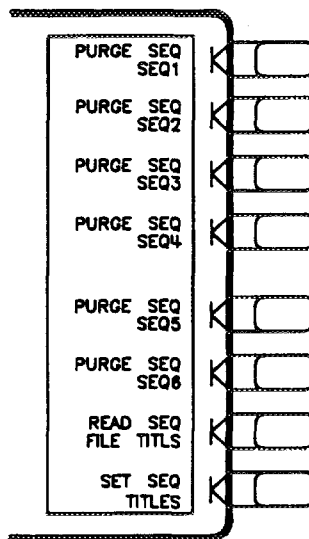

Figure 13-6. Purge Sequence from Disk Menu

[PURGE SEQ SEQ1] purges SEQ1 from disk.

[PURGE SEQ SEQ2] purges SEQ2 from disk.

[PURGE SEQ SEQ3] purges SEQ3 from disk.

[PURGE SEQ SEQ4] purges SEQ4 from disk.

[PURGE SEQ SEQ5] purges SEQ5 from disk.

[PURGE SEQ SEQ6] purges SEQ6 from disk.

[READ SEQ FILE TITLS] is a disk file directory command. Pressing this softkey will read the first six sequence titles and display them in the softkey labels as described in *Loading a Sequence When the Title Is Not Known*. These sequences can then be loaded into internal memory.

If **[READ SEQ FILE TITLS]** is pressed again, the next six sequence titles on the disk will be displayed. To read the contents of the disk starting again with the first sequence: remove the disk, reinsert it into the drive, and press **[READ SEQ FILE TITLS]**.

[GET SEQ TITLES] copies the sequence titles currently in memory into the six softkey positions.

Sequence More Menu

Figure 13-7 shows the commands available in the sequence more menu.

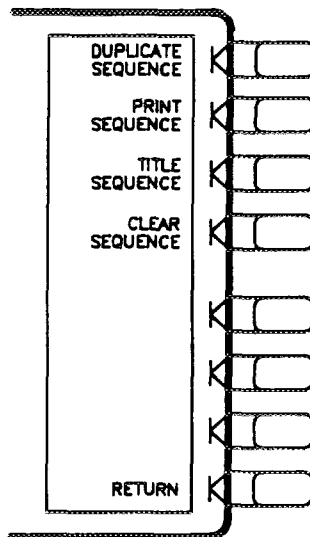

Figure 13-7. Sequence More Menu

[DUPLICATE SEQUENCE] (DUPLSEQxSEQy) duplicates a sequence currently in memory into a different softkey position. Duplicating a sequence is straightforward. Follow the prompts on the analyzer screen. This command does not affect the original sequence.

[PRINT SEQUENCE] (PRINSEQn) prints any sequence currently in memory to a compatible printer. Refer to *Accessories Available* in the *General Information and Specifications* section for a list of compatible printers. A procedure for printing a sequence is provided at the beginning of this chapter.

[TITLE SEQUENCE] (TITSEQn) allows the operator to rename any sequence with an eight character title. All titles entered from the front panel must begin with a letter, and may only contain letters and numbers. A procedure for changing the title of a sequence is provided at the beginning of this chapter.

[CLEAR SEQUENCE] (CLEASEn) clears a sequence from memory. The titles of cleared sequences will remain in load, store, and purge menus. This is done as a convenience for those who often reuse the same titles. A procedure for clearing a sequence is provided at the beginning of this chapter.

[RETURN] returns to the do sequence menu.

SEQUENCING SPECIAL FUNCTIONS

The purposes of some special functions are not obvious from the softkey label. Figure 13-8 shows all special function menus.

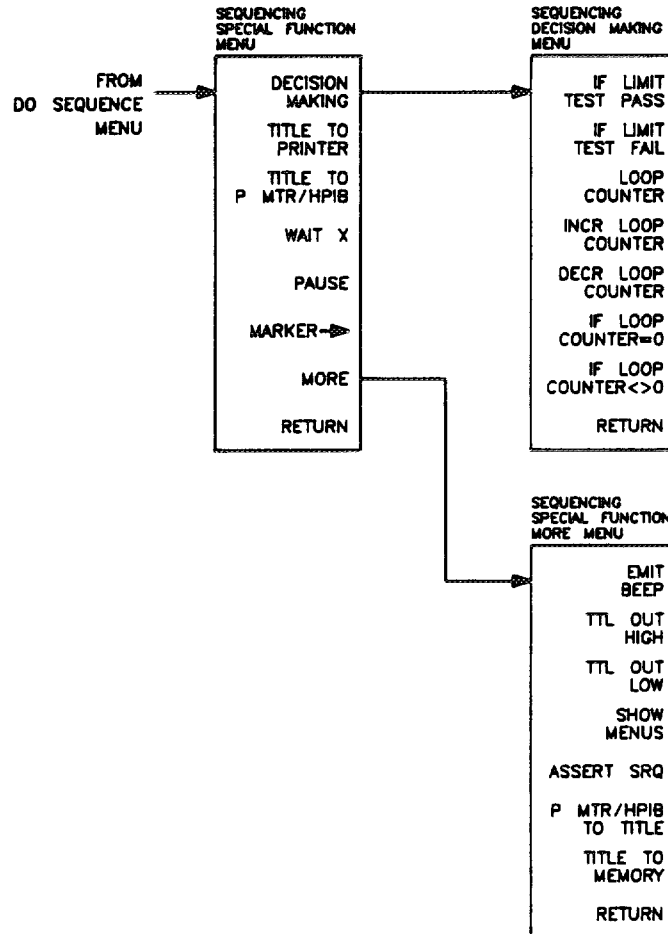

Figure 13-8. Sequencing Special Function Menus

Important Concepts

Some concepts presented in this chapter require explanation. Key concepts are explained below:

Sequence Title and Sequence Position. There are two attributes to any sequence. Each sequence has a title, and exists in one of the six sequence softkey positions. Softkey positions are referred to as SEQUENCE 1 through SEQUENCE 6, with position 1 at the top.

Decision Making Functions. Decision making functions are explained in more detail below. These functions check a condition and jump to a specified sequence if the condition is true. The sequence called must be in memory. A sequence call is a one-way jump, there is no equivalent to computer subroutines in sequencing. A sequence can jump to itself, or to any of the other five sequences currently in memory. Use of these features is explained under the specific softkey descriptions.

Decision making functions jump to a softkey location, not to a specific sequence title. Limit test, loop counter, and do sequence commands jump to any sequence residing in the specified sequence position (SEQUENCE 1 through 6). These commands do not jump to a specific sequence title. Whatever sequence is in the selected softkey position will run when these commands are executed.

Having a Sequence Jump to Itself. A decision making command can jump to the sequence it is in. When this occurs, the sequence starts over and all commands in the sequence are repeated. This is used a great deal in conjunction with loop counter commands. See the loop counter description below.

Limit Test Decision Making. A sequence can jump to another sequence or start over depending on the result of a limit test. When entered into a sequence, the **[IF LIMIT TEST PASS]** and **[IF LIMIT TEST FAIL]** commands require the operator to enter the destination sequence.

Loop Counter/Loop Counter Decision Making. The analyzer has a numeric register called a loop counter. The value of this register can be set by a sequence, and it can be incremented or decremented each time a sequence repeats itself. The decision making commands **[IF LOOP COUNTER = 0]** and **[IF LOOP COUNTER <> 0]** jump to another sequence if the stated condition is true. When entered into the sequence, these commands require the operator to enter the destination sequence. Either command can jump to another sequence, or restart the current sequence.

As explained later, the loop counter value can be appended to a title. This allows customized titles for data printouts or for data files saved to disk.

Autostarting Sequences

A sequence can be defined that will run automatically when power is applied to the analyzer. To make an autostarting sequence, create a sequence in position six and title it "AUTO". To stop an autostarting sequence, press **[LOCAL]**. To stop an autostarting sequence from engaging at power on, you must clear it from memory or rename it. Instructions for performing either task are provided near the beginning of this chapter.

Sequencing Special Function Menu

Figure 13-9 shows the commands available in this menu.

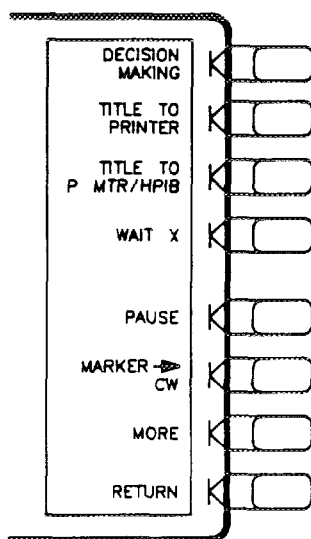

Figure 13-9. Sequencing Special Function Menu

[DECISION MAKING] presents the sequencing decision making menu.

[TITLE TO PRINTER] (TITTPRIN) outputs a title string to any device with an HP-IB address that matches the address set with the analyzer **[LOCAL]** **[SET ADDRESSES]** **[ADDRESS: PRINTER]** commands. This softkey is generally used for two purposes:

- Sending a title to a printer for data logging or documentation purposes.
- Sending commands to a printer or other HP-IB device.

When entering a sequence, create a display title and press **[TITLE TO PRINTER]**. When the sequence is run, the title will be sent to the printer. This command appends a carriage-return line feed (CR-LF) to the end of the string. The analyzer must be in system controller or pass control mode. To send a command to a printer or other HP-IB device, use the same procedure but enter the desired command as the title string.

[TITLE TO P MTR/HPIB] (TITTPMTR) outputs a title string to any device with an HP-IB address that matches the address set with the analyzer **[LOCAL]** **[SET ADDRESSES]** **[ADDRESS: P MTR/HPIB]** commands. This softkey is generally used for two purposes:

- Sending a title to a printer when a CR-LF is not desired.
- Sending commands to an HP-IB device.

When entering a sequence, create a display title containing a command or text string and press **[TITLE TO P MTR/HPIB]**. When the sequence is run, the string will be sent to the HP-IB device. The analyzer must be in system controller or pass control mode.

[WAIT X] (SEQWAIT) pauses the execution of subsequent sequence commands for x number of seconds. Terminate this command with **[x1]**.

Entering a 0 in wait x causes the instrument to wait for prior sequence command activities to finish before allowing the next command to begin. The wait 0 command only affects the command immediately following it, and does not affect commands later in the sequence.

[PAUSE] (PAUS) pauses the sequence so the operator can perform a needed task, such as changing the DUT, changing the calibration standard, or other similar task. Press **[CONTINUE SEQUENCE]** when ready.

[MARKER → CW] (MARKCW) sets the CW frequency of the analyzer to the frequency of the active marker.

[MORE] presents the sequencing special function more menu.

[RETURN] returns to the do sequence menu.

Sequencing Decision Making Menu

Figure 13-10 shows the commands available in this menu.

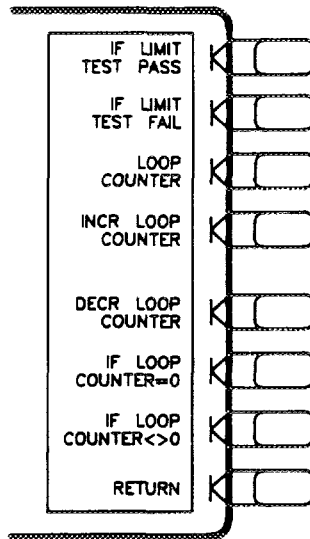

Figure 13-10. Sequencing Decision Making Menu

Limit Test Commands. Limit lines must be set up in the sequence before limit test pass/fail commands are performed. The limit test decision-making commands jump to a specified sequence if the conditions of the command are met.

Decision-Making Sequence Examples. Examples of limit test and loop counter sequences are provided at the end of this chapter.

[IF LIMIT TEST PASS] (IFLTPASS) jumps to one of the six sequence positions (SEQUENCE 1 through 6) if the limit test passes. This command executes any sequence residing in the selected position. Sequences may jump to themselves as well as to any of the other sequences in memory. When this softkey is pressed, the analyzer presents a softkey menu showing the six sequence positions, and the titles of the sequences located in them. Choose the sequence to be called if the limit test passes (destination sequence).

[IF LIMIT TEST FAIL] (IFLTFAIL) jumps to one of the six sequence positions (SEQUENCE 1 through 6) if the limit test fails. This command executes any sequence residing in the selected position. Sequences may jump to themselves as well as to any of the other sequences in memory. When this softkey is pressed, the analyzer presents a softkey menu showing the six sequence positions and the titles of the sequences located in them. Choose the destination sequence to be called if the limit test fails.

[LOOP COUNTER] (LOOC) sets the value of the loop counter. Enter any number from 0 to 32767 and terminate with the [x1] key. The default value of the counter is zero. This command should be placed in a sequence that is separate from the measurement sequence. For this reason: the measurement sequence containing a loop decision command must call itself in order to function. The **[LOOP COUNTER]** command must be in a separate sequence or the counter value would always be reset to the initial value.

[INCR LOOP COUNTER] (INCRLOOC) increments the value of the loop counter by 1.

[DECR LOOP COUNTER] (DECRLOOC) decrements the value of the loop counter by 1.

[IF LOOP COUNTER = 0] (IFLCEQZE) prompts the user to select a destination sequence position (SEQUENCE 1 through 6). When the value of the loop counter reaches zero, the sequence in the specified position will run.

[IF LOOP COUNTER <> 0] (IFLCNEZE) prompts the user to select a destination sequence position (SEQUENCE 1 through 6). When the value of the loop counter is no longer zero, the sequence in the specified position will run.

Sequencing Special Function More Menu

Figure 13-11 shows the commands available in this menu.

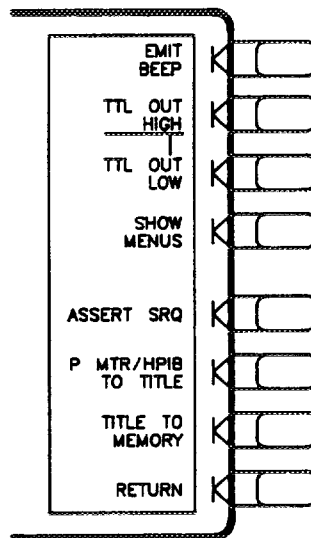

Figure 13-11. Sequencing Special Function More Menu

[EMIT BEEP] (EMIB) causes the instrument to beep once.

[TTL OUT HIGH] (TTLOH) sets the TTL output BNC on the back of the HP 85047A high.

[TTL OUT LOW] (TTLOL) sets the TTL output BNC on the back of the HP 85047A low.

[SHOW MENUS] (SHOM) used to display a specific menu prior to a pause statement.

Normally, the sequence list does not show menu softkeys. When **[SHOW MENUS]** is entered into a sequence, subsequent menu names will appear in the sequence list until a key is pressed that actually performs a function.

[ASSERT SRQ] (ASSS) sends an SRQ (service request) to the system controller.

[P MTR/HPIB TO TITLE] (PMTRTTIT) gets data from an HP-IB device set to the address at which the analyzer expects to find a power meter. The data is stored in a title string. The analyzer must be in system controller or pass control mode.

The external device should be given an interrogation command with the **[TITLE TO P MTR/HPIB]** or **[TITLE TO PRINTER]** command. When **[P MTR/HPIB TO TITLE]** is sent, the analyzer will wait indefinitely (or until **[LOCAL]** is pressed) for a string of up to 80 characters. The analyzer expects an EOI or line feed as a string terminator. This command can be used in conjunction with **[TITLE TO MEMORY]**, below.

[TITLE TO MEMORY] (TITMEM) moves the title string data obtained with the **[P MTR/HPIB TO TITLE]** command into a data array. **[TITLE TO MEMORY]** strips off leading characters that are not numeric, reads the numeric value, and then discards everything else. The number is converted into analyzer internal format, and is placed into the real portion of the memory trace at:

Display point = total points - 1 - loop counter

If the value of the loop counter is zero, then the title number goes in the last point of memory. If the loop counter is greater than or equal to the current number of measurement points, the number is placed in the first point of memory. A data to memory command must be executed before using the title to memory command.

[RETURN] returns to the sequencing special functions menu.

HP-GL CONSIDERATIONS

Entering HP-GL Commands

HP-GL commands can be entered locally or be included in a sequence.

HP-GL (Hewlett-Packard Graphics Language) can create customized messages or illustrations on the screen of the analyzer. To use HP-GL, the instrument must be in system controller mode.

HP-GL commands should be entered into a title string using the **[DISPLAY]** **[MORE]** **[TITLE]** and character selection menu.

The **[TITLE TO P MTR/HPIB]** or **[TITLE TO PRINTER]** sequencing commands send the HP-GL command string to the instrument's HP-GL address. The analyzer needs no HP-IB cables connected to it to perform HP-GL commands. The address of the analyzer HP-GL graphics interface is always offset from the instrument's HP-IB address by 1:

- If the current instrument address is an even number:
HP-GL address = instrument address + 1.
- If the current instrument address is an odd number:
HP-GL address = instrument address - 1.

Special Commands

Two HP-GL commands require special consideration when used in local operation or in sequencing. These are explained below:

Plot Absolute (HP-GL command: PA). The syntax for this command is PAx,y where x and y are screen location coordinates separated by a comma. The title function on the analyzer does not have a comma, so the analyzer allows x and y coordinates to be separated with a forward slash "/".

Label (HP-GL command: LB). The syntax for this command is LB[text][etx]. The label command will print ASCII characters until the etx command is seen. The etx is the ASCII value 3 (not the ASCII character 3).

The analyzer title function does not have the ASCII value 3, so the instrument allows the LB command to be terminated with the **[END OF LABEL]** command (accessed by pressing **[DISPLAY]** **[MORE]** **[TITLE]** **[MORE]** **[END OF LABEL]**).

HP-GL is described in Appendix D of the *HP-IB Quick Reference* and in *Example 3, User Interface*, in the *HP-IB Programming Guide*.

ENTERING SEQUENCES USING HP-IB

A sequence can be created in a computer controller using HP-IB codes and entered into the analyzer over HP-IB. The process is the same as entering a sequence locally – the same keystrokes are used. This method replaces the keystrokes with HP-IB commands. The following is a procedure for entering a sequence over HP-IB:

1. Send the HP-IB command NEWSEQx where x is a number from 1 to 6.
2. Send the HP-IB commands for the measurement.
3. Terminate with the HP-IB command DONM (done modify).

READING SEQUENCES USING HP-IB

An external controller can read the commands in any sequence (in HP-IB command format). Send the following command to the analyzer:

OUTPSEQx where x is a number from 1 to 6.

Allocate an adequate amount of string variable space in the external controller and execute an ENTER statement.

DECISION-MAKING SEQUENCE EXAMPLES

Limit Test Example Sequence:

This example assumes limit line setup commands have been entered earlier in the sequence:

Keys Pressed	Sequence List On Screen	Explanation
[SYSTEM] [LIMIT MENU] [LIMIT LINE ON]	LIMIT LINE ON	Turn on previously set up limit lines.
[LIMIT TEST ON]	LIMIT TEST ON	Turn limit testing on.
[MEAS] [B/R] [SCALE REF] [2] [x1]	B/R SCALE/DIV 2 x 1	Measurement commands.
[MENU] [TRIGGER MENU] [SINGLE]	SINGLE	Update the data and limit test.
[SYSTEM] [SEQUENCING MENU] [SPECIAL FUNCTIONS] [DECISION MAKING] [IF LIMIT TEST PASS] [SEQUENCE 4 SEQ4]	IF LIMIT TEST PASS THEN DO SEQUENCE 4	Jump to the sequence in sequence position 4 if the limit test passes.
[RETURN] [MORE] [EMIT BEEP]	EMIT BEEP	Test failed, beep to inform operator.
[RETURN] [PAUSE]	PAUSE	Pause to let the operator change DUT.
[RETURN] [DO SEQUENCE] [SEQUENCE 1 SEQ1] [DONE MODIFY]	DO SEQUENCE SEQUENCE 1	Jump back to the start of this sequence. Exit the modify (edit) mode.

Loop Counter Example Sequence:

Initial Sequence Position and Title: SEQUENCE 1 SEQ1

Key Pressed	Sequence List On Screen	Explanation
[SYSTEM] [SEQUENCING MENU] [NEW SEQ/MODIFY SEQ] [SEQUENCE 1 SEQ1]	Start of Sequence	Enter modify (edit) mode.
[RECALL] [RECALL PRST STATE]	RECALL PRST STATE	Preset the instrument
[MEAS] [Trans: FWD S21 (B/R)]	Trans: FWD S21 (B/R)	Set up an S21 measurement
[LOCAL] [SYSTEM CONTROLLER]	SYSTEM CONTROLLER	Set the analyzer to system controller mode
[SET ADDRESSES] [ADDRESS: PRINTER] [1] [x1]	ADDRESS: PRINTER 1 x1	Set the analyzer's address for the printer
[SYSTEM] [SEQUENCE MENU] [SPECIAL FUNCTIONS] [DECISION MAKING] [LOOP COUNTER] [5] [x1]	LOOP COUNTER 5 x1	Set loop counter value to 5
[RETURN] [RETURN] [DO SEQUENCE] [SEQUENCE 2 SEQ2]	DO SEQUENCE SEQUENCE 2	Jump to the sequence in sequence position 2
[DONE MODIFY]		Leave the modify (edit) mode.

Second Sequence Position and Title: SEQUENCE 2 SEQ2

Key Pressed	Sequence List On Screen	Explanation
[SYSTEM] [SEQUENCING MENU] [NEW SEQ/MODIFY SEQ] [SEQUENCE 1 SEQ1]	Start of Sequence	Enter modify (edit) mode.
[DISPLAY] [MORE] [TITLE] Press [ERASE TITLE]. Enter "DUT" with knob and [SELECT LETTER]. Press [MORE] [LOOP COUNTER] [RETURN] [DONE]	TITLE DUT [LOOP]*	Enter the title "DUT[LOOP]"* Create customized title.
[SYSTEM] [SEQUENCING MENU] [SPECIAL FUNCTIONS] [PAUSE]	SYSTEM PAUSE	The operator should connect or change the DUT

* When the test results are printed, each title will have a different numeric value at the end (DUT00005, DUT00004, DUT00003, DUT00002, and DUT00001). Note that the loop counter value always contains five digits.

Key Pressed	Sequence List On Screen	Explanation
[MENU] [TRIGGER MENU] [SINGLE] [COPY] [PRINT]	SINGLE PRINT	Take a sweep to update the data Results are printed with title DUTx (x=loop #)
[SYSTEM] [SEQUENCING MENU] [SPECIAL FUNCTIONS] [DECISION MAKING] [DECR LOOP COUNTER] [IF LOOP COUNTER <> 0]	DECR LOOP COUNTER IF LOOP COUNTER <> 0 THEN DO SEQUENCE 2	Decrement loop counter If the value of the loop counter is not equal to zero, loop back and test another DUT.
[DISPLAY] [MORE] [TITLE] Press [ERASE TITLE]. Enter "TEST IS FINISHED" with knob and [SELECT LETTER] softkey. Press [DONE]	TITLE TEST IS FINISHED	If loop counter = zero, exit loop and display "TEST IS FINISHED" "TEST IS FINISHED" is displayed on the screen
[SYSTEM] [SEQUENCING MENU] [DONE MODIFY]		Exit modify (edit) mode.



Chapter 14. Instrument Modes, 6 GHz, Frequency Offset, and Harmonic Operation

CHAPTER CONTENTS

- 14-1 Introduction
- 14-2 Instrument Modes
- 14-2 Instrument Mode Overview
- 14-4 Network Analyzer Mode
- 14-4 External Source Mode
- 14-6 Tuned Receiver Mode
- 14-8 Other System Key Features
- 14-8 Feature Overview
- 14-8 Frequency Offset Operation
- 14-12 6 GHz Operation (Option 006 Only)
- 14-14 Harmonic Operation (Option 002 Only)
- 14-17 Spurious Signal Passbands in External Source Mode, Tuned Receiver Mode, and Frequency Offset Operation

INTRODUCTION

This chapter describes the three major instrument modes of the analyzer:

- Network analyzer mode.
- External source mode.
- Tuned receiver mode.

In addition, three features are described:

- Frequency offset operation.
- 6 GHz mode operation (option 006 only).
- Harmonic mode operation (option 002 only).

For each of these topics, the following information is provided:

- The primary measurement application in which each mode or feature is used.
- A complete description of each mode or feature with a typical test setup.
- Formulas for calculating spurious signal passbands for external source mode, tuned receiver mode, and for frequency offset operation.

All of the features described in this chapter are accessible under the [SYSTEM] key. Figure 14-1 shows the relationship of the menus described in this chapter.

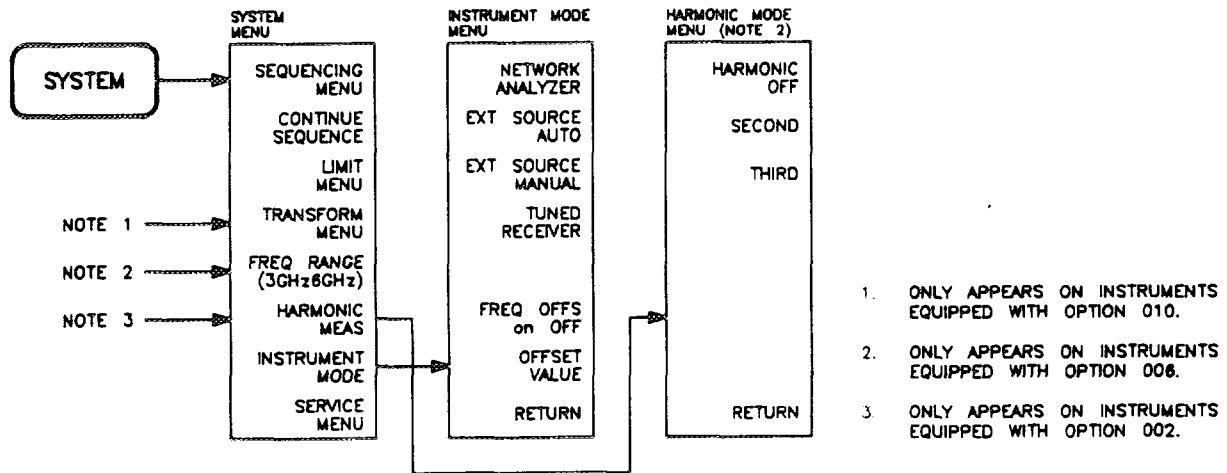

Figure 14-1. Relationship of Applicable [SYSTEM] Key Menus

Instrument Modes

INSTRUMENT MODE OVERVIEW

There are three major modes of operation in the analyzer:

Network Analyzer Mode

This is the standard mode of operation for the analyzer, and is active after preset or power-on. Network analyzer mode in the HP 8753C is similar to the operation of the HP 8753A/B.

External Source Mode

This mode allows the analyzer to phase lock to an external CW signal. External source mode has the following features and limitations:

- It is phase-locked.
- It functions only in CW time sweep.
- It does not require a synthesized source.

The external source's signal should not have large sidebands or spurs.

Tuned Receiver Mode

In tuned receiver mode, the analyzer receiver operates independently of any signal source. The following features and limitations apply to the tuned receiver mode:

- It is not phase-locked
- It functions in all sweep types
- It requires a synthesized CW source
- It is much faster than external source mode

Getting to the Instrument Mode Menu

Pressing **[SYSTEM] [INSTRUMENT MODE]** brings up the instrument mode menu, illustrated in Figure 14-2.

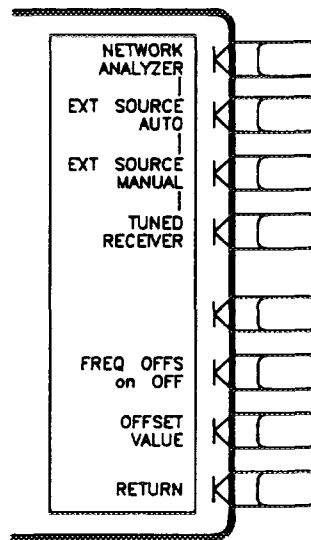

Figure 14-2. Instrument Mode Menu

[NETWORK ANALYZER] returns the analyzer to the “normal” network analyzer operating mode. This mode uses the analyzer’s built-in source.

[EXTERNAL SOURCE AUTO] turns on the external source auto mode: This mode allows the analyzer to phase lock to an external CW signal. This works only in CW time sweep. The incoming signal should not have large spurs or sidebands, as the analyzer may phase lock on a spur instead of the fundamental. The auto mode has a wider capture range than the manual mode. Refer to *External Source Mode* for details.

[EXTERNAL SOURCE MANUAL] Turns on the external source manual mode. This mode has a smaller capture range than the auto mode. However, manual mode is much faster than auto mode. This feature works only in CW time sweep type.

[TUNED RECEIVER] The analyzer receiver operates independently of any signal source. This mode is not phase locked and functions in all sweep types. The analyzer tunes the receiver for a synthesized CW input signal at a precisely specified frequency. All phase lock routines are bypassed, increasing sweep speed significantly. The external source must be synthesized, and must drive the analyzer’s external frequency reference.

[FREQ OFFS on OFF] (frequency offset operation) allows phase-locked operation with a frequency offset between the internal source and receiver. Frequency offset is not an instrument mode, it is a feature accessible in the network analyzer mode. This feature is used in swept RF mixer measurements and has an upper frequency limit of 3 GHz.

[OFFSET VALUE] Press this softkey to enter the offset (LO) frequency for frequency offset operation.

NETWORK ANALYZER MODE

The network analyzer mode is the standard mode of operation for the analyzer, and is active at power-on or preset.

EXTERNAL SOURCE MODE

The receiver (input R) detects and phase locks to an externally generated CW signal. Receiver inputs A and B can measure this same frequency for comparison or tracking measurements. Two types of external source operation are provided, automatic and manual. Refer to the *External Source Mode In-Depth Description* on the next page.

If a synthesized external source is used, the tuned receiver mode is recommended because it is faster. External source mode is best used for unknown signals, or for signals that drift.

Primary Applications

External source mode is useful in several applications:

- When the DUT is a mixer or other frequency translation device.
- In automated test applications where a source is already connected to the system, and the operator does not wish to switch between the system source and the analyzer's internal source.
- When an HP 8753 option 006 is used above 3 GHz without an HP 85047A test set. (This requires an external source and signal separation device.)

Typical Test Setup

Figure 14-3 shows a typical test setup using the external source mode. The same test setup is applicable to either manual or automatic external source mode operation.

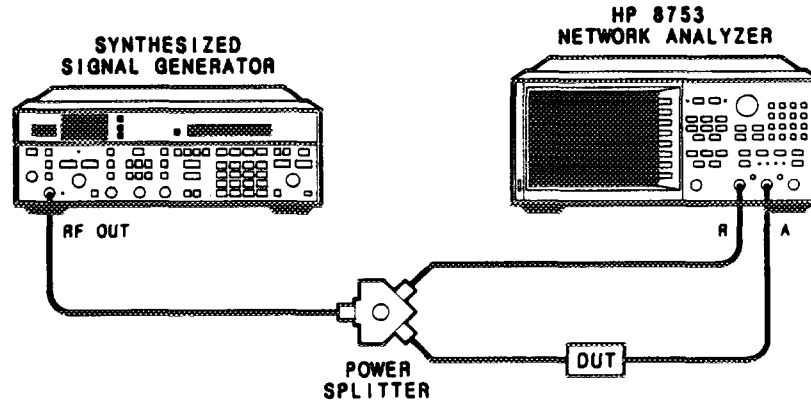

Figure 14-3. Typical Test Setup for External Source Mode

External Source Mode In-Depth Description

External source may be used in automatic or manual mode. External source mode phase locks the analyzer to an external CW signal. This feature only works in CW time sweep.

External Source Auto. The external source auto mode searches for the incoming CW signal. The capture range is typically 10% of the selected CW frequency. The manual mode is faster than the auto mode. The frequency the instrument has locked onto is displayed on the CRT, and is also available via HP-IB.

The external source should not exhibit noise or significant sidebands, as this may cause the analyzer to phase lock on a spur or not lock at all.

External Source Manual. The incoming signal should not have large spurs or sidebands for the reasons explained above. This mode is faster than the auto mode, but it does not search for the incoming signal. The frequency of the incoming signal should be within -0.5 to $+5.0$ MHz of the selected frequency or the analyzer will not be able to phase lock to it.

Frequency Range. 300 kHz to 3 GHz (6 GHz for option 006)

Compatible Sweep Types. The external source mode will only function in CW time sweep. If the instrument is in any other sweep type when external source is activated, the warning message "CHANGED TO CW TIME MODE" will appear on the display.

External Source Requirements. The external source mode has spectral purity and power input requirements, which are described in the specifications table in the *General Information and Specifications* section of his manual.

Input Channels: R, A, B

Capture Range. In either automatic or manual mode, the operator enters the frequency of the external CW signal using the **[CW FREQ]** softkey (located under the Stimulus **[MENU]** key). The actual signal must be within a certain frequency capture range as shown in table 14-1.

Table 14.1 External Source Capture Ranges

Automatic Mode	
Above 50 MHz: Below 50 MHz:	$\pm 10\%$ of nominal CW frequency ± 5 MHz of nominal CW frequency
Manual Mode	
All frequencies	-0.5 to $+5$ MHz of nominal CW frequency

If the incoming signal is not within the capture range, the analyzer will not phase lock properly. Also, the signal should not be sweeping.

Locking Onto a Signal with a Frequency Modulation Component. Although the analyzer may phase-lock onto a signal with FM on it, it may not accurately show the signal's amplitude. The accuracy of such measurements depends greatly on the chosen IF bandwidth. Use the widest IF bandwidth available (3 kHz) if this problem occurs.

Spurious Signal Passband Frequencies. Because of the characteristics of the sampler, spurious signals present at certain frequencies can cause measurement inaccuracy. These frequencies can be calculated. Refer to *Spurious Signal Passbands In External Source Mode, Tuned Receiver Mode, and Frequency Offset Operation* at the end of this chapter.

TUNED RECEIVER MODE

In tuned receiver mode, the analyzer's receiver operates independently of any signal source. This mode is not phase locked and functions in all sweep types. The analyzer tunes the receiver to a synthesized CW input signal at a precisely specified frequency. All phase lock routines are bypassed, increasing sweep speed significantly. The external source must be synthesized, and must drive the analyzer external frequency reference.

Primary Applications

The tuned receiver mode is useful for these applications:

- Automated test applications where an external synthesized source is available.
- In applications where speed is important. This mode does not phase lock and is much faster than the external source mode.

Typical Test Setup

Figure 14-4 shows a typical test setup using tuned receiver mode in a CW measurement. The incoming signal can be input to either the A, B, or R inputs. Inputs A and B have greater dynamic range.

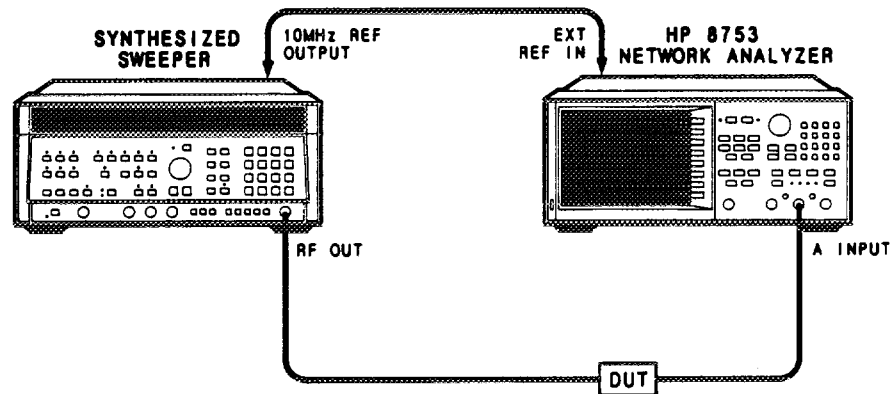

Figure 14-4. Typical Test Setup for Tuned Receiver Mode

The tuned receiver mode is typically used in CW applications. An example of non-CW operation is a third order intermodulation measurement using list mode, manual trigger, and an external synthesized source. Refer to the third order intermodulation measurement description in product note 8753-1, *Amplifier Measurements with the HP 8753*, HP part number 5956-4361.

Tuned Receiver Mode In-Depth Description

Frequency Range. 300 kHz to 3 GHz (6 GHz for option 006)

Compatible Sweep Types. All sweep types may be used.

External Source Requirements. The tuned receiver mode has the following input requirements:

Input: A, B, or R

Input power range specifications are provided in the specifications table, located in the *General Information and Specifications* section of this manual.

Spurious Signal Passband Frequencies. Because of the characteristics of the sampler, spurious signals present at certain frequencies can cause measurement inaccuracy. These frequency passbands in the sampler can be calculated. Refer to *Spurious Signal Passbands In External Source Mode, Tuned Receiver Mode, and Frequency Offset Operation* at the end of this chapter.

Other System Key Features

FEATURE OVERVIEW

Three features are described:

- Frequency offset operation.
- 6 GHz operation (option 006 only).
- Harmonic operation (option 002 only).

The applicable system-related softkeys are shown in Figure 14-1, at the beginning of this chapter.

Frequency Offset Operation

Sets the RF source to a fixed offset frequency above the receiver as required in a mixer test using a swept RF/IF and fixed LO. This allows a device to be stimulated over one frequency range and its response to be viewed over another. Frequency offset can be used in any sweep type, and in external source or tuned receiver instrument modes.

6 GHz Operation (Option 006 Only)

6 GHz operation is activated by the *[FREQ RANGE 3GHz6GHz]* softkey. This feature toggles the receiver between two frequency ranges:

- 300 kHz to 3 GHz.
- 3 MHz to 6 GHz.

The frequency range softkey appears only on an analyzer equipped with option 006, and then only when connected to an HP 85047A 6 GHz test set. The receiver may be used up to 6 GHz without the HP 85047A test set, in external source or tuned receiver modes or in harmonic operation. 6 GHz operation can be used in any sweep type or instrument mode.

Harmonic Measurements (Option 002 Only)

The harmonics feature measures the second or third harmonic as the analyzers source sweeps fundamental frequencies above 16 MHz. Harmonic measurements may be made in any sweep type or instrument mode.

FREQUENCY OFFSET OPERATION

This sets the RF source to a fixed offset frequency above the receiver as required in a mixer test using a swept RF/IF and fixed LO. This allows a device to be stimulated over one frequency range and its response to be viewed over another. The maximum delay between the RF source and the R input is 3 microseconds. The displayed signal is a composite of the desired RF signal, image response, and spurious signals.

Frequency offset can be used in any sweep type in network analyzer mode. The two user-defined variables in this mode are receiver frequency (IF) and offset frequency (LO). Source frequency (RF) is automatically set by the instrument and equals $IF + LO$.

Mixer measurements and frequency offset mode applications are explained in application note 8753-2, *RF Component Measurements – Mixer measurements using the HP 8753B network analyzer*, HP part number 5956-4362. This application note was written for the HP 8753B but also applies to the HP 8753C.

Primary Applications

Frequency offset mode is useful for the following types of measurements on a frequency-translating device:

- Conversion loss
- Conversion compression
- Amplitude and phase tracking

Typical Test Setup

Figure 14-5 shows a typical test setup using frequency offset mode. Instructions are provided in *Using Frequency Offset Mode*. The attenuators shown reduce mismatch uncertainties. The low pass filter keeps unwanted mixing products out of the HP 8753 sampler.

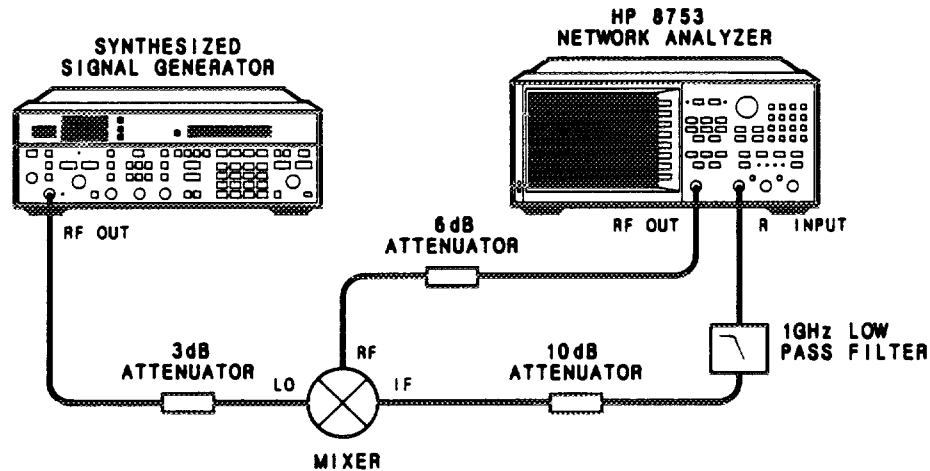

Figure 14-5. Typical Test Setup for a Frequency Offset Measurement

Frequency Offset In-Depth Description

In frequency offset operation, the source and the receiver operate at two different frequencies. The difference between the source and receiver frequencies is the user-specified offset frequency.

The two user-defined variables in frequency offset are the receiver (IF) frequency, and the offset (LO) frequency. The source frequency (RF) is automatically set by the instrument and equals $IF + LO$.

- **The receiver frequency (IF)** is the CW or start and stop frequencies chosen by the operator. These are entered in the normal way using the **[CW FREQ]** softkey or **[START]** and **[STOP]** keys. It is very important to understand that the stimulus values only affect the receiver (IF). The CRT always displays IF frequencies.
- **The offset frequency (LO)** is the difference between the source and receiver frequencies.

NOTE: The analyzer's source locks to the $IF + LO$ frequency, regardless of the selected offset value. Once the source is phase locked and sweeping, the analyzer's source frequency is not known precisely. As the LO frequency changes, the source tracks it to maintain the requested IF frequency (the receiver start/stop or CW frequency).

Frequency Hierarchy. The source frequency must be greater than the LO frequency, and both source and LO frequencies must be greater than the receiver frequency. This means that the frequency offset mode can only measure the lower of the two IF mixing products (lower sideband).

Example:

Right (lower sideband)	Wrong (upper sideband)
Source frequency (RF) = 3 GHz	Source frequency (RF) = 3 GHz
Offset frequency (LO) = 2.5 GHz	Offset frequency (LO) = 0.5 GHz
Receiver frequency (IF) = 0.5 GHz	Receiver frequency (IF) = 2.5 GHz

Frequency Ranges. Receiver (IF) frequency range = 300 KHz to 2.984 GHz.
Minimum recommended offset (LO) frequency = 16 MHz.

The receiver frequency plus the offset frequency cannot exceed 3 GHz. (This is because the source must be able to supply the sum of the receiver frequency plus the offset frequency.) If the operator enters IF and LO frequencies that would require >3 GHz from the source, the analyzer automatically limits the requested IF frequency.

Compatible Instrument Modes and Sweep Types. Frequency offset is compatible with all sweep types in network analyzer mode.

Receiver and Source Requirements. Refer to the specifications table located in the *General Information and Specifications* section of this manual.

IF Input: A, B, or R

CRT Annotations. The annotation "ofs" is displayed when the frequency offset mode is on. The annotation "of?" indicates that the source frequency is approximately ≥ 10 MHz away from the sum of the requested IF and LO frequencies. This is most likely caused by the LO frequency being outside the -1 to $+5$ MHz accuracy requirement.

Error Message. If the operator connects a DUT before turning on the frequency offset function, the error message "PHASE LOCK CAL FAILED" will appear on the screen. This is normal, and will go away when the **[FREQ OFFS on OFF]** softkey is pressed.

Spurious Signal Passband Frequencies. Because of the characteristics of a sampler, unwanted mixing products (or spurious LO signals) at specific frequencies can cause measurement inaccuracy. These specific frequencies can be calculated. Refer to *Spurious Signal Passbands In External Source Mode, Tuned Receiver Mode, and Frequency Offset Operation*, at the end of this chapter. A low pass filter on the DUT's IF output can reduce unwanted mixing products going to the sampler.

Using Frequency Offset Mode

Activate frequency offset mode using the following sequence:

1. Press **[FREQ OFFS on OFF]** to turn on the frequency offset mode.
2. Connect the DUT and set the external LO source to the desired frequency and power level.
3. Set the receiver (IF) frequencies using the **[CW FREQ]** softkey or **[START]** and **[STOP]** keys. Set the output power of the RF source and select the input (R, A, or B).
4. Set the offset (nominally the LO frequency) using the **[OFFSET VALUE]** softkey.

Example Measurement. The following example measures conversion loss in a typical mixer application. The following frequencies are used in this measurement:

- RF = 1400 MHz (automatically set by the analyzer).
- LO = 800 MHz (entered by the operator using the **[OFFSET VALUE]** softkey).
- IF = 600 MHz (entered by the operator using the stimulus keys).

Remember that during frequency offset measurements the analyzer displays IF frequencies on the CRT.

1. Press **[PRESET]** on the front panels of the analyzer and local oscillator (LO) source.
2. Press **[FREQ OFFS on OFF]** to activate the frequency offset mode. Connect the equipment as shown in Figure 14-5.

NOTE: If you connect the DUT before turning on frequency offset, the error message "PHASE LOCK CAL FAILED" may be displayed. This is normal, and will go away when frequency offset mode is turned on.

3. Set the LO signal generator to a CW frequency of 800 MHz at +13 dBm.
4. From the front panel of the analyzer, set the IF frequency and RF source output power. Select the R input.

[MENU]
[CW FREQ] [6] [0] [0] [M/u]
[POWER] [6] [x1]
[MEAS] [R]

5. Enter the LO (offset) frequency.

[SYSTEM] [INSTRUMENT MODE]
[OFFSET VALUE] [8] [0] [0] [M/U]

6. Figure 14-6 shows the attenuated output power of the mixer's IF at the receiver. The conversion loss of the mixer is found by subtracting the attenuation from the total loss between the RF source and IF receiver.

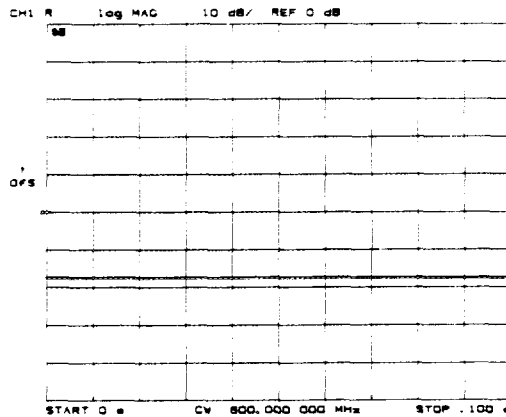

Figure 14-6. Mixer Output

Source power	=	6 dBm
Output power	=	-17.5 dBm
Total loss	=	23.5 dB
Total attenuation	=	16 dB
Conversion loss	=	7.5 dB

6 GHz OPERATION (OPTION 006)

6 GHz operation is activated by the **[FREQ RANGE 3GHz6GHz]** softkey. The frequency range softkey appears only on an analyzer equipped with option 006, and then only when it is connected to an HP 85047A 6 GHz test set. The softkey appears in two instances:

- On the screen after power-on or instrument preset.
- Under the system menu as shown in Figure 14-1.

[FREQ RANGE 3GHz6GHz] (FREQRANG3GHZ, FREQRANGE6GHZ) toggles between two frequency ranges:

- 300 kHz to 3 GHz
- 3 MHz to 6 GHz

The current maximum frequency is highlighted in the softkey title. For example, when 300 kHz to 3 GHz is selected, the **[3GHz]** portion of the softkey title will be highlighted, while the **[6GHz]** portion will appear dim.

Compatible Instrument Modes

6 GHz operation works in all instrument modes: network analyzer, external source, and tuned receiver.

Activating 6 GHz Operation

In network analyzer mode, 6 GHz operation must be turned on directly with the **[FREQ RANGE 3GHz6GHz]** softkey, or by HP-IB command. It can not be activated by simply selecting frequencies above 3 GHz. If this is attempted, the message "3GHz MAX FREQ. USE FREQ RANGE KEY (UNDER SYSTEM)" will be displayed. This stipulation also applies to using frequencies above 3 GHz during frequency offset operation.

When activated, the power output of the internal source will automatically change to +20 dBm. Start and Stop frequencies change to 3 MHz and 6 GHz respectively. The reason the power level changes is explained under *RF Power Requirements*, below. When the operator changes the analyzer back to the 3 GHz mode, power changes to 0 dBm and Start/Stop frequencies change to 300 kHz and 3 GHz respectively. In addition, the sweep type changes to linear sweep.

When using an option 006 in external source mode, tuned receiver mode, or harmonic operation, frequencies above 3 GHz can be measured without turning on 6 GHz operation.

When 6 GHz mode is on, the status annotation "x2" is displayed on the CRT.

Doubler Switch Protection (HP 85047A)

The HP 85047A S-parameter test set uses a frequency doubler to switch between 3 and 6 GHz operation. Because the doubler uses a mechanical switch, operations that would require repetitive switching between the two modes are not permitted. For this reason, 6 GHz mode is either on or off for both channels. There is no override for this protection feature.

RF Power Requirements

The doubler requires high, fixed power (+20 dBm). When the operator selects 6 GHz operation, the analyzer RF power output automatically changes to +20 dBm and the message "SOURCE FREQUENCIES AND POWER CHANGED" is displayed. If the operator then changes the source power, a warning message appears, and the status annotation changes from "x2" to "x2?"

Receiver-Only Use of the HP 8753 Option 006. Three modes allow the option 006 receiver to measure up to 6 GHz without an HP 85047A test set. Each mode can measure signals up to 6 GHz without activating the 6 GHz mode. (In fact, without the HP 85047A test set, the analyzer will not display the **[FREQ RANGE 3GHz6GHz]** softkey.)

Receiver-Only use in External Source and Tuned Receiver modes. The external source or tuned receiver modes allow the analyzer to measure frequencies up to 6 GHz without an HP 85047A test set. However, an external source and signal separation device must be supplied. Refer to *External Source Mode* or *Tuned Receiver Mode* descriptions in this chapter.

Receiver-Only use in Harmonic Mode (option 002). With option 002, harmonic operation, the fundamental frequency can not exceed 3 GHz. However, harmonic frequencies up to 6 GHz can be measured without activating 6 GHz operation. Receiver-only use is limited to simple transmission measurements. The HP 85047A test set is required for reflection measurements because its couplers can operate to 6 GHz. If using the 6 GHz test set, it should be left in the 3 GHz mode. Refer to *Harmonic Operation (Option 002 Only)*.

The second harmonic of fundamental frequencies up to 3 GHz can be measured, as well as the third harmonic of fundamental frequencies up to 2 GHz.

HARMONIC OPERATION (OPTION 002 ONLY)

The harmonic measurement mode measures the second or third harmonic as the analyzer's source sweeps fundamental frequencies above 16 MHz.

Typical Test Setup

Figure 14-7 shows a typical test setup using the HP 85047A 6 GHz test set.

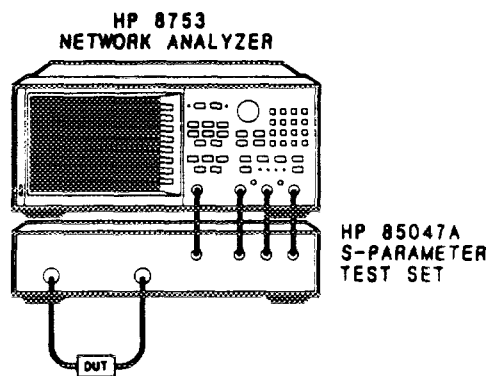

Figure 14-7. Typical Harmonic Mode Test Setup

HP 85047A Test Set Requirement

For measuring harmonic responses above 3 GHz, the HP 85047A 6 GHz test set is required for reflection measurements since its couplers work above 3 GHz. A test set is not required for a simple transmission measurement. This is because the selected frequency is the fundamental, which never exceeds 3 GHz. If using an option 006 with an HP 85047A test set, keep the analyzer in the 300 kHz to 3 GHz range.

Harmonic measurements may be made in any sweep type.

Single-Channel Operation

The second or third harmonic can be displayed alone using channel 1 or 2.

Dual-Channel Operation

To make the following types of measurements, channels 1 and 2 must be uncoupled, and dual channel must be turned on.

- The fundamental can be displayed on one channel while the second or third harmonic is displayed on the other channel.
- The second harmonic can be displayed on one channel while the third harmonic is displayed on the other.

- The **[D2/D1 to D2]** softkey allows the fundamental to be measured on channel 1 while the second or third harmonic is measured in dBc on channel 2.
- The **[COUPLE PWR ON off]** softkey couples power between channels 1 and 2. This is useful when using the D2/D1 to D2 feature; the user can change fundamental power and see the resultant change in the harmonic power.

The display (stimulus annotation and marker stimulus) will display the fundamental frequency. However, a marker in the active entry area will show the harmonic frequency in addition to the fundamental. If the harmonic mode is used, the annotation "H=2" or "H=3" will appear on the left-hand side of the display. The measured harmonic cannot not exceed the frequency limitations of the network analyzer's receiver.

Coupling Power Between Channels 1 and 2

[COUPLE PWR ON off] is intended for use with the **[D2/D1 to D2 on OFF]** softkey. The D2/D1 to D2 function is used in harmonic measurements, where the fundamental is displayed on channel 1 and the harmonic on channel 2. D2/D1 to D2 ratios the two, displaying the fundamental and the relative power of the measured harmonic in dBc. For these measurements, channels 1 and 2 must be uncoupled with the **[COUPLED CHAN ON off]** softkey set to OFF to allow alternating sweeps.

After uncoupling channels 1 and 2, you may wish to change the fundamental power and see the resultant change in relative harmonic power (in dBc). **[COUPLE PWR ON off]** allows the operator to change the power of both channels simultaneously, even though they are uncoupled in all other respects.

Frequency Range

The frequency range is determined by the upper frequency range of the instrument or system (3 or 6 GHz) and by the harmonic being displayed. 6 GHz operation requires an HP 8753 option 006. Table 14-2 shows the highest fundamental frequency for maximum frequency and harmonic mode.

Table 14-2. Fundamental Frequency for Maximum Frequency and Harmonic Mode

	Maximum Frequency	
	3 GHz	6 GHz (Option 006)
2nd Harmonic	1.5 GHz	3 GHz
3rd Harmonic	1.0 GHz	2.0 GHz

Example: A standard analyzer has a maximum frequency range of 3 GHz. If the second harmonic is being measured, the highest fundamental frequency allowed is 1.5 GHz.

Accuracy and Input Power

Refer to the specifications table located in the *General information and specifications* section of this manual. Related specifications are the maximum recommended input power and maximum recommended source power.

Using power levels greater than the recommended values causes undesired harmonics in the source and receiver. The recommended power levels ensure that these harmonics are less than 45 dBc. Use port attenuation in an S-parameter test set to limit the input power to the DUT.

Harmonic Measurement Menu

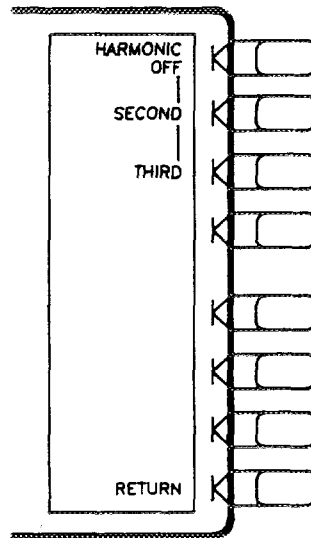

Figure 14-8. Harmonic Measurement Menu

[HARMONIC OFF] (HARMOFF) turns off the harmonic measurement mode.

[SECOND] (HARMSEC) selects measurement of the second harmonic.

[THIRD] (HARMTHIR) selects measurement of the third harmonic.

[RETURN] goes back to the system menu.

Getting to the [D2/D1 toD2] or [COUPLE PWR ON off] Softkeys.

- Press [DISPLAY] [MORE] [MORE] to access the [D2/D1 toD2] softkey.
- Press [MENU] [POWER] to access the [COUPLE PWR ON off] softkey.

SPURIOUS SIGNAL PASSBANDS IN EXTERNAL SOURCE MODE, TUNED RECEIVER MODE, AND FREQUENCY OFFSET OPERATION

The external source mode, tuned receiver mode, and frequency offset feature respond to spurious signals at certain passband frequencies. A signal at any of these frequencies affects the accuracy of the measurement. Filters can be used to reduce the effect of spurious signals at passband frequencies. Refer to the following information to calculate the passband frequencies.

Calculating the Spurious Signal Passband at RF Frequencies Below 16 MHz

Below 16 MHz, spurious signals in a single frequency range will affect the accuracy of measurements. This frequency range is centered around the selected RF frequency, and is the width of the selected IF bandwidth.

$$\text{Spurious signal Passband} = \text{RF} \pm 0.5 \times \text{IF Bandwidth}$$

For example: A 10 MHz signal is measured with an IF bandwidth of 1 kHz. The spurious signal passband = 10 MHz \pm 500 Hz

Calculating Susceptible Spurious Signal Frequencies at RF Frequencies Above 16 MHz

Above 16 GHz, there are a series of frequencies at which spurious signals will affect the accuracy of the measurement. The following information explains how to calculate these frequencies.

The variables in this calculation are:

n = numbers 1 through 300.

FN = fractional-N frequency (calculate as explained later)

The basic formula is:

$$\text{Spurious Signal frequencies} = (n \times \text{FN}) + 1 \text{ MHz}$$

The calculation must be repeated with n values from 1 to 300. This will provide the frequency of all significant spurious passbands.

Calculating FN. FN is dependent upon RF frequency, the Mth harmonic number, and the IF frequency. The formula is:

$$\text{FN} = \frac{\text{RF} - \text{IF}}{\text{Mth Harmonic}}$$

Convenient lookup tables are provided so the operator may easily find IF and Mth harmonic values.

Three lookup tables are provided because the values of IF and Mth harmonic depend on if the harmonics operation (option 002) mode is turned on. The three tables are:

- Table 14-3, Harmonics Mode Off.
- Table 14-4, Harmonics Mode On, Second Harmonic Selected (option 002 only).
- Table 14-5, Harmonics Mode On, Third Harmonic Selected (option 002 only).

Using a table. The following are instructions for using the FN lookup tables.

1. Choose the proper table given non-harmonic, second harmonic, or third harmonic mode.
2. Find the appropriate RF frequency row.
3. Look in the IF and Mth harmonic columns for the applicable values.

Example Passband Calculation for a CW Frequency Above 16 MHz

In this example, harmonics mode is off and the RF frequency is 62 MHz. Table 14-3 indicates an IF value of 1 MHz and an Mth harmonic value of 2.

$$FN = \frac{RF - IF}{\text{Mth Harmonic}}$$

$$\frac{62 \text{ MHz} - 1 \text{ MHz}}{2} = 30.5 \text{ MHz}$$

Now using the formula for determining spurious passbands:

$$\text{Passband Frequencies} = (n \times FN) + 1 \text{ MHz}$$

(where n = 1 to 300)

$$(1 \times 30.5 \text{ MHz}) + 1 \text{ MHz} = 31.5 \text{ MHz}$$

$$(2 \times 30.5 \text{ MHz}) + 1 \text{ MHz} = 62 \text{ MHz}$$

$$(3 \times 30.5 \text{ MHz}) + 1 \text{ MHz} = 92.5 \text{ MHz}$$

and so on...

*Table 14-3. IF and Mth Harmonic Values with Harmonic Mode Off
(Or if Option 002, Harmonic Operation, is Not Installed)*

RF (MHz)	Mth Harmonic	IF (MHz)
≥ 16 to < 61	1	1
≥ 61 to < 121	2	1
≥ 121 to < 178	3	1
≥ 178 to < 296	5	1
≥ 296 to < 536	9	1
≥ 536 to < 893	15	1
≥ 893 to < 1607	27	1
≥ 1607 to < 3060	51	1
≥ 3060 to 6000	101	1

Table 14-4. IF and Mth Harmonic Values with Harmonic Mode On, Second Harmonic Selected

RF (MHz)	Mth Harmonic	IF (MHz)
≥ 15.5 to < 60.5	1	0.5
≥ 60.5 to < 120.5	2	0.5
≥ 120.5 to < 177.5	3	0.5
≥ 177.5 to < 295.5	5	0.5
≥ 295.5 to < 535.5	9	0.5
≥ 535.5 to < 892.5	15	0.5
≥ 892.5 to < 1606.5	27	0.5
≥ 1606.5 to < 3059.5	51	0.5
≥ 3059.5 to 6000	101	0.5

Table 14-5. IF and Mth Harmonic Values with Harmonic Mode On, Third Harmonic Selected

RF (MHz)	Mth Harmonic	IF (MHz)
≥ 15.333 to < 60.333	1	0.333
≥ 60.333 to < 120.333	2	0.333
≥ 120.333 to < 177.333	3	0.333
≥ 177.333 to < 295.333	5	0.333
≥ 295.333 to < 535.333	9	0.333
≥ 535.333 to < 892.333	15	0.333
≥ 892.333 to < 1606.333	27	0.333
≥ 1606.333 to < 3059.333	51	0.333
≥ 3059.333 to 6000	101	0.333



Appendix A

PRESET STATE

When the [PRESET] key is pressed, the analyzer reverts to a known state. This state is defined in Table A-1, below. There are subtle differences between the preset state and the power-up state. These differences are documented in Table A-2. If power to non-volatile memory is lost, the analyzer will have certain parameters set to default settings. Table A-3 shows the affected parameters.

When line power is cycled, or the [PRESET] key pressed, the analyzer performs a self-test routine. Upon successful completion of that routine, the instrument state is set to the following preset conditions. The same conditions are true following a "PRES;" or "RST;" command over HP-IB, although the self-test routines are not executed.

Table A-1. Preset Conditions (1 of 2)

Operating Parameter	Preset Value	Operating Parameter	Preset Value
Analyzer Mode ANALYZER MODE	Network Analyzer Mode	DISPLAY	data
FREQUENCY OFFSET OPERATION	off	COLOR SELECTIONS	same as before
OFFSET VALUE	0		[PRESET]
HARMONIC OPERATION	off	DUAL CHANNEL	off
3 GHz/6 GHz OPERATION	3 GHz	ACTIVE CHANNEL	channel 1
Stimulus Conditions		FREQUENCY BLANK	disabled
SWEEP TYPE	linear frequency	SPLIT DISPLAY	on
DISPLAY MODE	start/stop	INTENSITY	If set to $\geq 15\%$, [PRESET] has no effect.
TRIGGER TYPE	continuous		If set to $< 15\%$, [PRESET] increases
EXTERNAL TRIGGER	off		intensity to 15%.
SWEEP TIME	100 milliseconds, manual mode	BEEPER: DONE	on
START FREQUENCY	.300 MHz	BEEPER: WARNING	off
FREQUENCY SPAN	2999.7 MHz	D2/D1 TO D2	off
START TIME	0	TITLE	channel 1 = [hp]
TIME SPAN	100 milliseconds		channel 2 = empty
CW FREQUENCY	1000 MHz	NUMBER OF POINTS	201
SOURCE POWER	0 dBm	IF BANDWIDTH	3000 Hz
POWER SLOPE	0 dB/GHz; off	IF AVERAGING FACTOR	16; off
START POWER	-5.0 dBm	SMOOTHING APERTURE	1% SPAN; off
POWER SPAN	5 dB	PHASE OFFSET	0 degrees
COUPLED POWER	on	ELECTRICAL DELAY	0 seconds (all parameters)
POWER TRIP	off		
COUPLED CHANNELS	on	Calibration	
Frequency List		CORRECTION	off
FREQUENCY LIST	empty	CALIBRATION TYPE	none
EDIT MODE	start/stop, number of points	CALIBRATION KIT	7 millimeter
Response Conditions		SYSTEM Z0	50 ohms
PARAMETER (with S-parameter test set)	channel 1: S11; channel 2: S21	VELOCITY FACTOR	1
(without S-parameter test set)	channel 1: A/R; channel 2: B/R	EXTENSIONS	off
CONVERSION	off	PORT 1	0
FORMAT	log magnitude (all inputs)	PORT 2	0
		INPUT A	0
		INPUT B	0

Table A-1. Preset Conditions (2 of 2)

Operating Parameter	Preset Value	Operating Parameter	Preset Value		
Calibration (Cont'd)		External Memory Array (Define Store)			
ALTERNATE A and B	on	DATA	off		
POWER METER CALIBRATION ¹	off	RAW DATA	off		
NUMBER OF READINGS	1	FORMATTED DATA	off		
POWER LOSS CORRECTION	off	GRAPHICS	off		
SENSOR A/B	A	DATA ONLY	off		
INTERPOLATED ERROR CORRECTION	off	DIRECTORY SIZE	256 files		
Markers (coupled)		SAVE USING	binary		
MARKERS 1,2,3,4	1 GHz; all markers off	Sequencing²			
LAST ACTIVE MARKER	1	LOOP COUNTER	0		
REFERENCE MARKER	none	TTL OUT	high		
MARKER MODE	continuous	Service Modes			
DISPLAY MARKERS	on	HP-IB DIAGNOSTIC	off		
DELTA MARKER MODE	off	SOURCE PHASE LOCK LOOP	on		
COUPLING	on	SAMPLER CORRECTION	on		
MARKER SEARCH	off	SPUR AVOIDANCE	on		
MARKER TARGET VALUE	-3 dB	AUX INPUT RESOLUTION	high		
MARKER WIDTH VALUE	-3 dB; off	ANALOG BUS NODE	11 (aux input)		
MARKER TRACKING	off	Plot			
MARKER STIMULUS OFFSET	0	PLOT DATA	on		
MARKER VALUE OFFSET	0	PLOT MEMORY	on		
MARKER AUX OFFSET (PHASE)	0 degrees	PLOT GRATICULE	on		
MARKER STATISTICS	off	PLOT TEXT	on		
POLAR MARKER	LIN MKR	PLOT MARKER	on		
SMITH MARKER	R + jX	PLOT QUADRANT	FULL PAGE		
Limit Lines		SCALE PLOT	FULL		
LIMIT LINES	off	PLOT SPEED	FAST		
LIMIT TESTING	off				
LIMIT LIST	empty	Plot (Cont'd)			
EDIT MODE	upper/lower limits	PEN NUMBER:	Channel 1	Channel 2	
STIMULUS OFFSET	0 Hz	Data	1	2	
AMPLITUDE OFFSET	0	Memory	1	2	
LIMIT TYPE	sloping line	Graticule	3	4	
BEEP FAIL	off	Text	1	2	
Time Domain		Marker	5	6	
TRANSFORM	off	LINE TYPE			
TRANSFORM TYPE	bandpass	Data, Memory	7	7	
START TRANSFORM	-20 nanoseconds				
TRANSFORM SPAN	40 nanoseconds	Format Table	Scale	Reference	
GATING	off			Position	Value
GATE SHAPE	normal	LOG MAGNITUDE (dB)	10.0		Marker Offset
GATE START	-10 nanoseconds	PHASE (degree)	90.0	5.0	0.0
GATE SPAN	20 nanoseconds	GROUP DELAY (ns)	10.0	5.0	0.0
DEMODULATION	off	SMITH CHART	1.00	-	1.0
WINDOW	normal	POLAR	1.00	-	1.0
USE MEMORY	off	LINEAR MAGNITUDE	0.1	0.0	0.0
System Parameters		REAL	0.2	5.0	0.0
HP-IB ADDRESSES	last active state	IMAGINARY	0.2	5.0	0.0
HP-IB MODE	last active state	SWR	1.00	0.0	1.0
INTENSITY and FOCUS	last active state				
Test Set Attenuation					
PORT 1	0				
PORT 2	0				

1. The power sensor calibration data and power loss tables are not affected by preset or by cycling line power.
 2. Pressing preset turns off sequencing modify (edit) mode and stops any running sequence.

Table A-2. Power-on Conditions (versus Preset)

<p>HP-IB MODE: Talker/listener.</p> <p>SAVE REGISTERS: Memory, error correction data, and power meter calibration data in save registers are cleared.</p> <p>COLOR DISPLAY: Default color values</p> <p>TEST SET: The analyzer checks for presence of HP 85046A/B or 85047A.</p> <p>INTENSITY: These values are set to factory encoded values. The factory values can be changed by running the appropriate service routine. Refer to the Troubleshooting Reference section of the service manual.</p> <p>SEQUENCES: Sequence 1 through 5 are erased.</p>

Table A-3. Results of Power Loss to Non-Volatile Memory

<p>HP-IB ADDRESSES are set to the following defaults:</p>	
HP 8753B	16
USER DISPLAY	17
PLOTTER	5
PRINTER	1
POWER METER	13
DISK	0
DISK UNIT NUMBER	0
DISK VOLUME NUMBER	0
<p>POWER METER TYPE is set to HP 438A/437</p>	
<p>INTERNAL REGISTER TITLES are set to defaults: REG1 through REG5.</p>	
<p>EXTERNAL REGISTER TITLES (store files) are set to defaults: FILE1 through FILE 5.</p>	

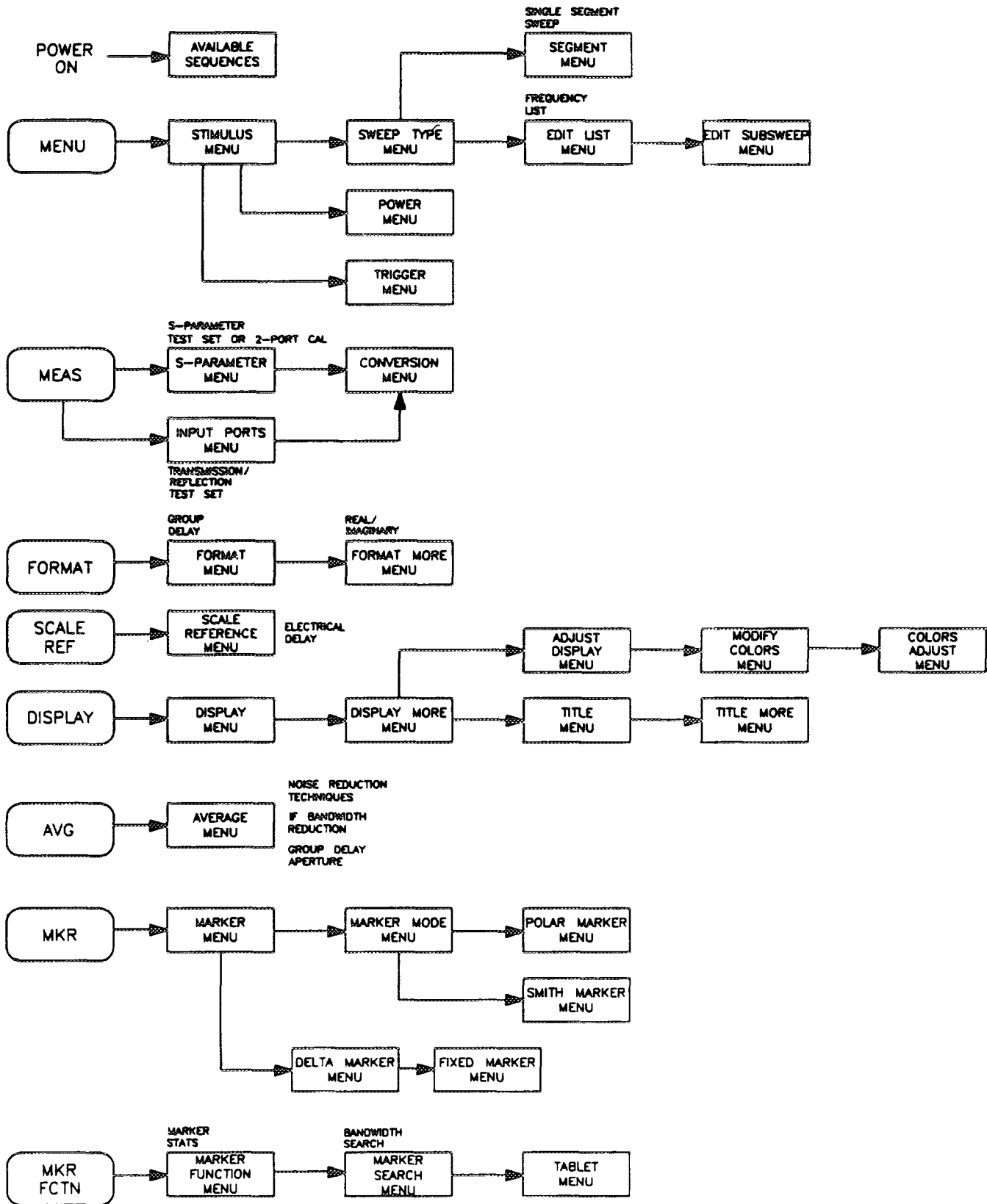

Figure A-1. Operating Softkey Menu Map (1 of 4)

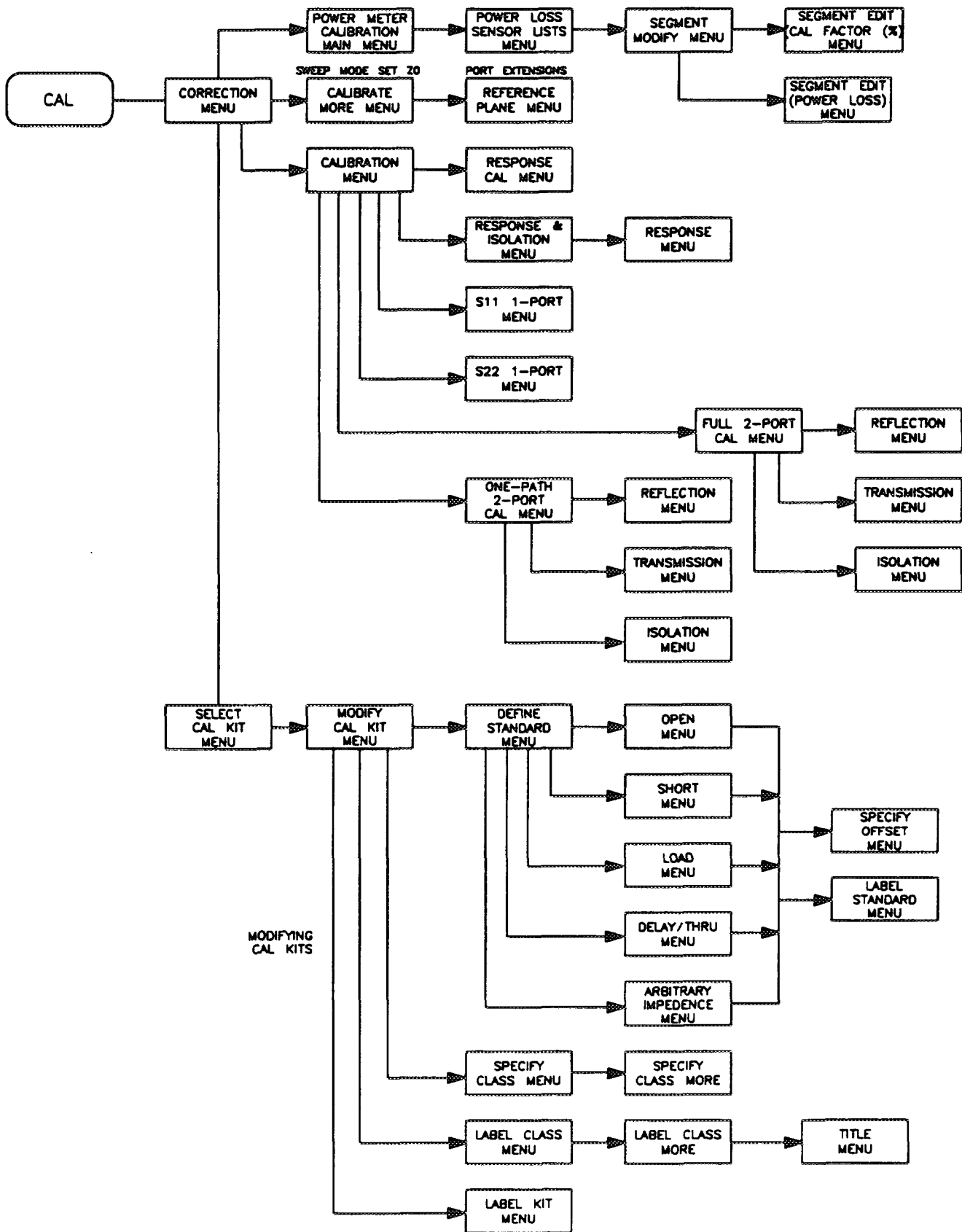

Figure A-1. Operating Softkey Menu Map (2 of 4)

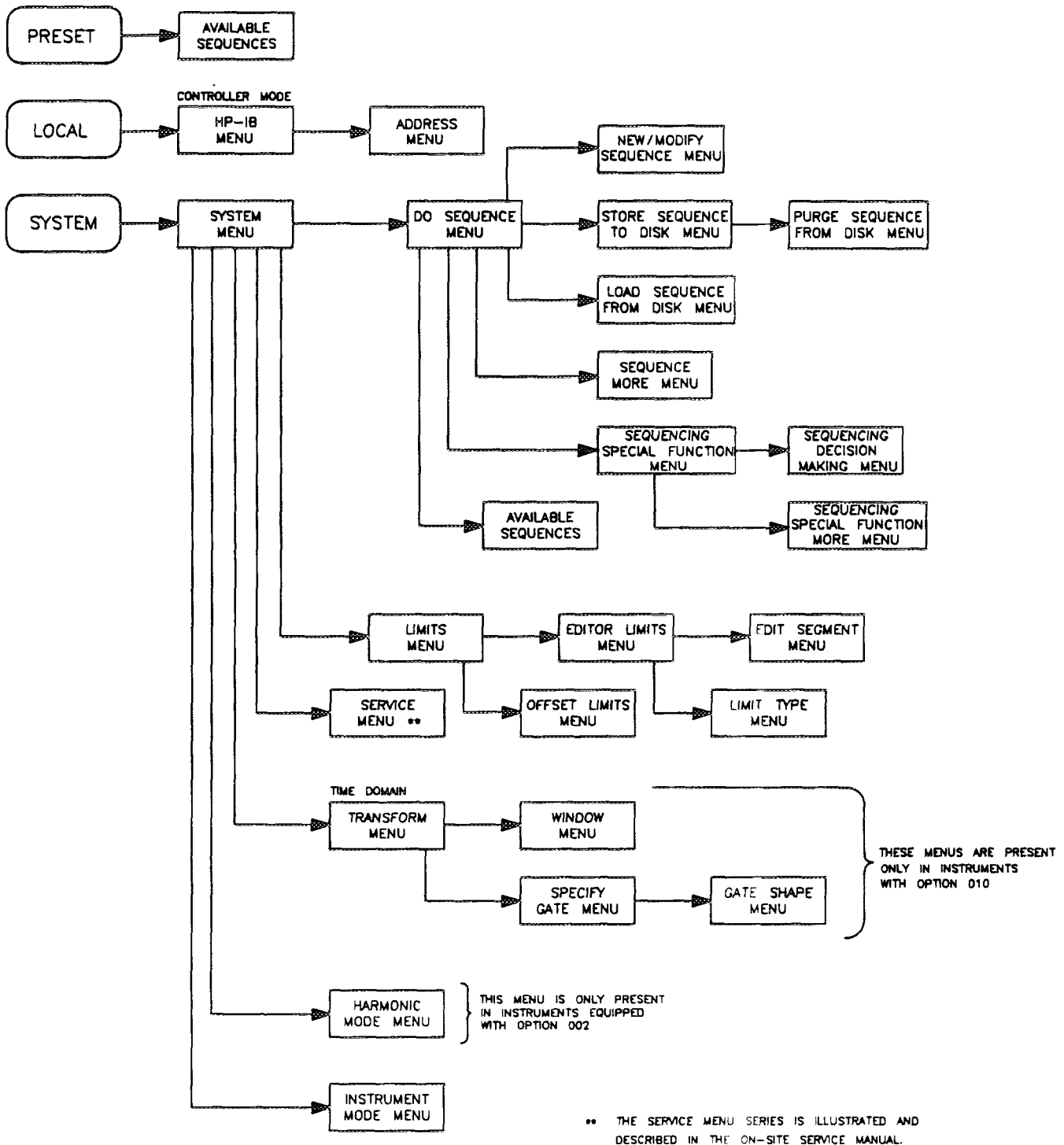

Figure A-1. Operating Softkey Menu Map (3 of 4)

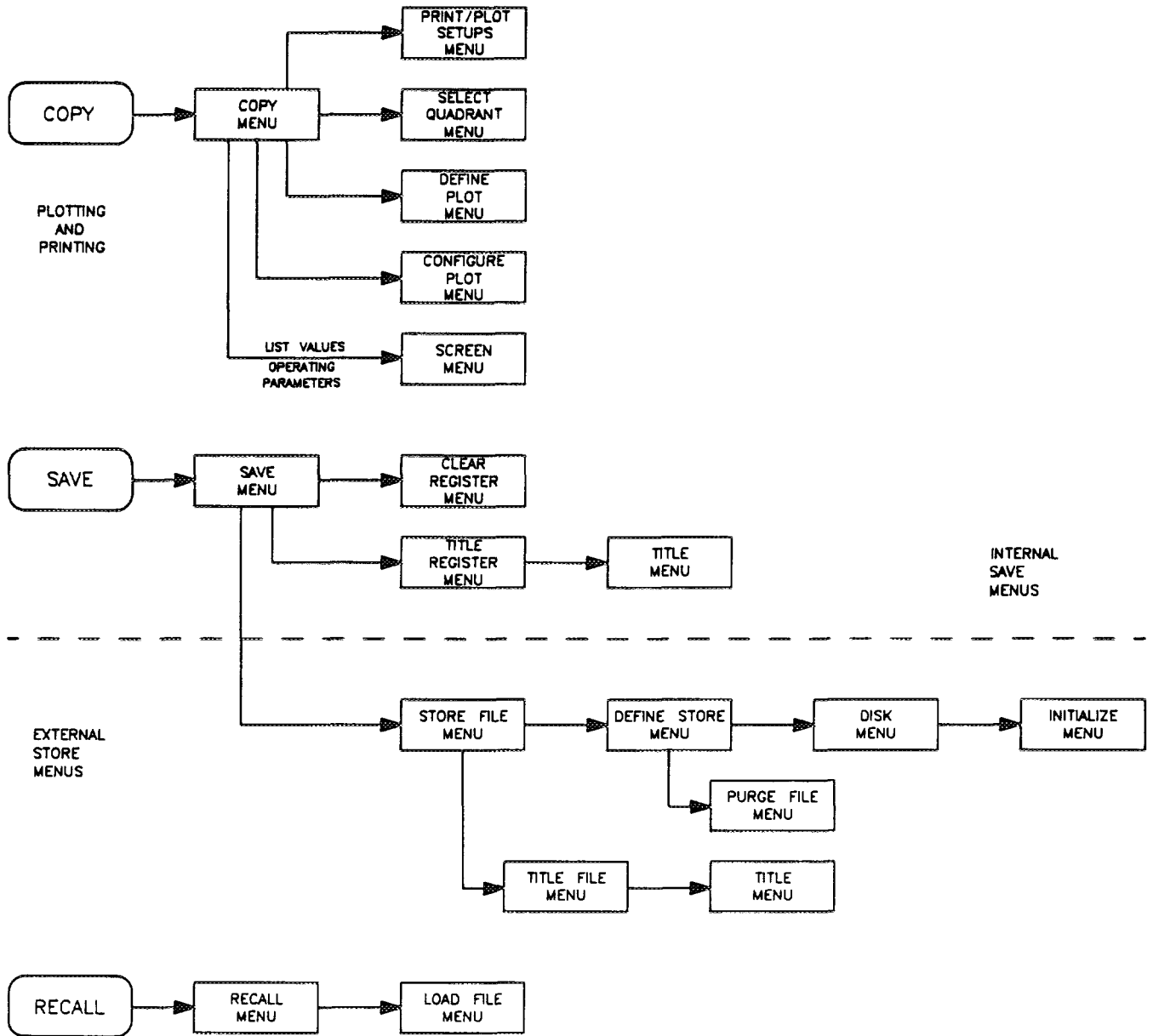

Figure A-1. Operating Softkey Menu Map (4 of 4)

